

DOORS & WINDOWS



INTELLIGENT
ALUMINIUM

itswallpanel.com



Intelligent Aluminium

2024



**INTELLIGENT
ALUMINIUM**

itswallpanel.com

About Us

We Intelligent Aluminium, creates Doors and windows with an objective of being a complete solution provider with world-class innovative ideas incorporated into our products. It also focuses on ways to get rid of the monotonous solutions for windows. Building reliable and innovative products that are thoughtfully created for today's need.





INTELLIGENT
ALUMINIUM
itsallpanel.com

Intelli Slim

Intelligent Aluminium brings to you a pre-fabricated aluminium windows and door solution, manufactured at single point by the same company that designs as well as installs its own systems with international standards.

Intelli Slim Series Demonstrates an abstract presentation of precision and simplicity.



Intelli Slim
Sliding



Intelli Slim
Casement



Design and installation



Custom made & Pre-fabricated



Single point of manufacturing



All International Standards

Discover Slimline's wide variety of windows & doors for your home.

Sliding

Sliding windows glide open horizontally from one side, providing easy access to fresh air. Sliding windows are popular in contemporary style homes as well as in basements, tight spaces or rooms that need extra ventilation.

Intelli Slim Sliding Windows
Intelli Slim Sliding Doors

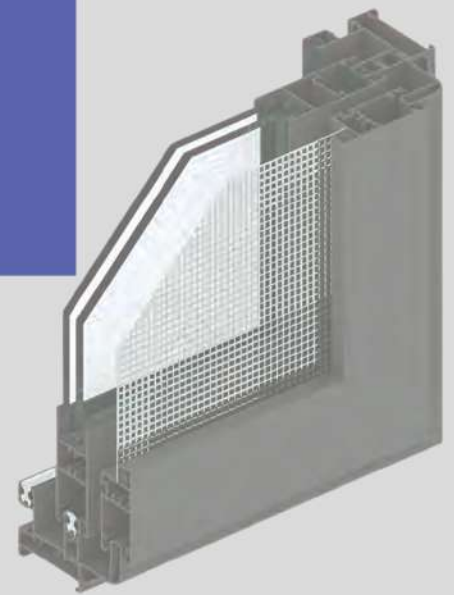

Casement

Casement windows are hinged at the sides and swing outward and inward. Easily opening and closing with a crank that folds away when not in use, casement windows are a great option for hard-to-reach spaces.

Intelli Slim Casement Windows
Intelli Slim Casement Doors





Technical Specifications

INTELLI SLIM SLIDING WINDOWS & DOORS

Variant		2 Track	3 Track	4 Track
System Size	Outer frame width	66mm	105mm	144mm
	Vent Width	31.0mm		
Visible dimensions	Outer frame height	47.3mm		
	Handle section	70.0mm		
	Top/Bottom section depth	70.0mm		
	Interlock section depth	50.0mm		
Profiles				
Aluminium	Alloy 6063-T4/T5/T6			
Wall Thickness	Minimum profile thickness 1.5mm- 1.8mm			
Glazing				
Glass thickness Single Glazing	6mm to 12mm			
Glass thickness Double Glazing Sealing	(5+8+5)=18mm. (5+10+5), (6+8+6), (4+12+4) =20mm All glass glazing with EPDM, Sliding with brush seals			
Assembly Specifications				
Corner connection Frame	90 assembly with patented frame insert			
Corner connection Shutter	90 overlapping			
Design Specifications				
Wind Load	Typical wind load 1800Pa, as per IS 8147-1976, Wind loads are considered as per IS 875-III			
Bug Mesh	Glass reinforced fibre mesh/stainless steel(optional) considered as per IS 875-III			
Hardware	All eurogroove type 1 compatible, single/multipoint locking possibilities			
Color	Profile finish in RAL powder coating, wood grain finish, anodisation			

INTELLI SLIM CASEMENT WINDOWS & DOORS

Variant		
System depth	Outer frame width	40.0mm
	Vent / Shutter	49.0mm
Visible dimensions	Window Door shutter width	78.4mm
	Door shutter width	92.5mm
	T-Profile window	70.0mm
	T-Profile door	100.0mm
	Glazing bead height	21.0mm
Profiles		
Aluminium	Alloy 6063-T4/T5/T6	
Wall Thickness	Minimum profile thickness 1.5mm- 1.8mm	
Glazing		
Glass thickness	6mm to 20mm	
Sealing	All glass glazing with EPDM	
Assembly Specifications		
Corner connection	Screw corner cleat	
Frame and Shutter		
Design Specifications		
Wind Load	Wind loads are considered as per IS 875-III.	
Hardware	All eurogroove type 1 compatible, single/multipoint locking possibilities.	
Color	Profile finish in RAL powder coating, wood grain finish, anodisation.	





INTELLIGENT
ALUMINIUM
itswallpanel.com

IA-90

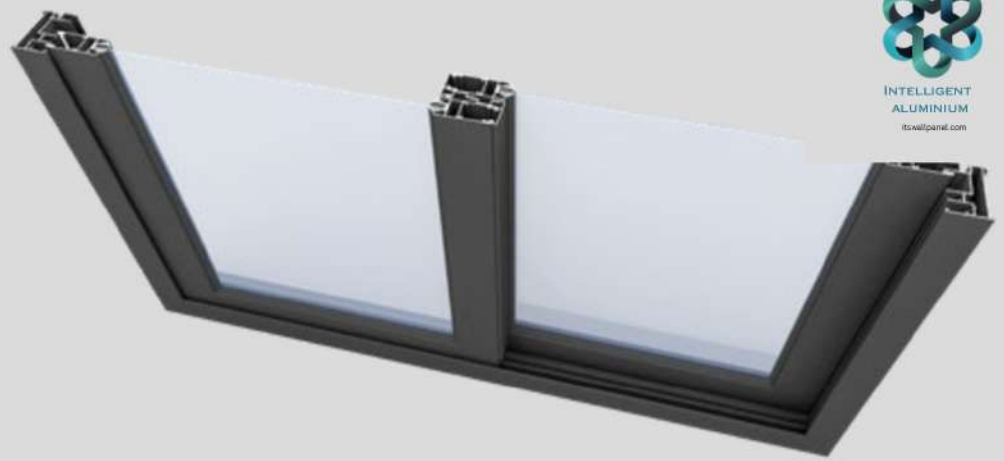

An ideal solution for apartment flats and commercial building offering impressive and functional results.

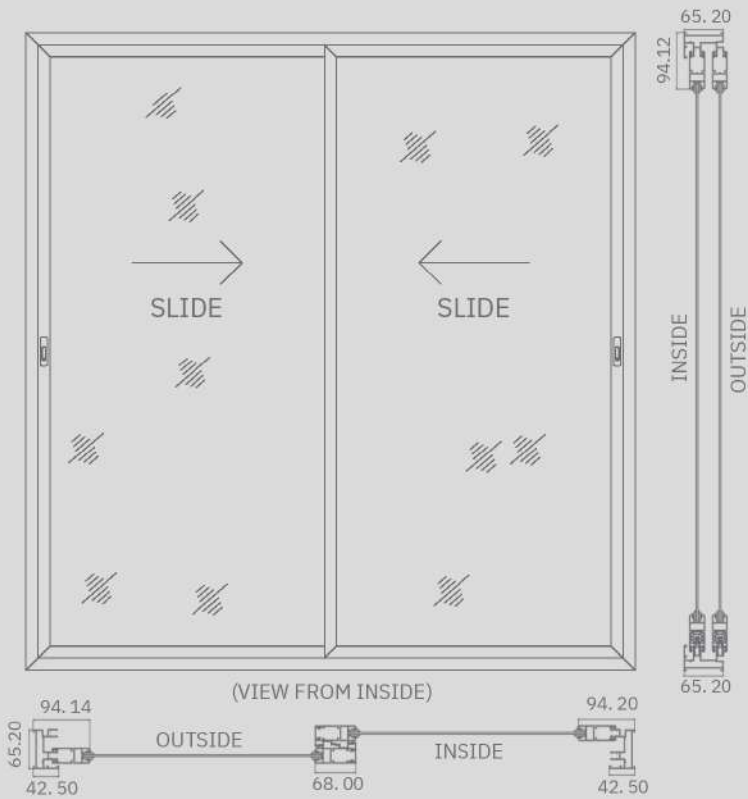

Shutter Size	2	25 mm x 63 mm
Track	3 Track	65 mm x 42.5 mm
Window Height		101 mm x 42.5 mm
Sash Weight		Max. 1800 mm
Hardware		Max. 70 Kgs
Joinery Detail		Single / Multipoint Locking
Glazing Options		45° with corner connector
Glazing		Single
Thickness		5 mm / 6 mm
Mosq. Mesh		Tear resistant Fibre Mesh
Finish		Powder coating (Satin / Textured finish) Wood effect powder coating

This system is resistant to air, water and wind pressure with High Performance Accessories.



IA-91

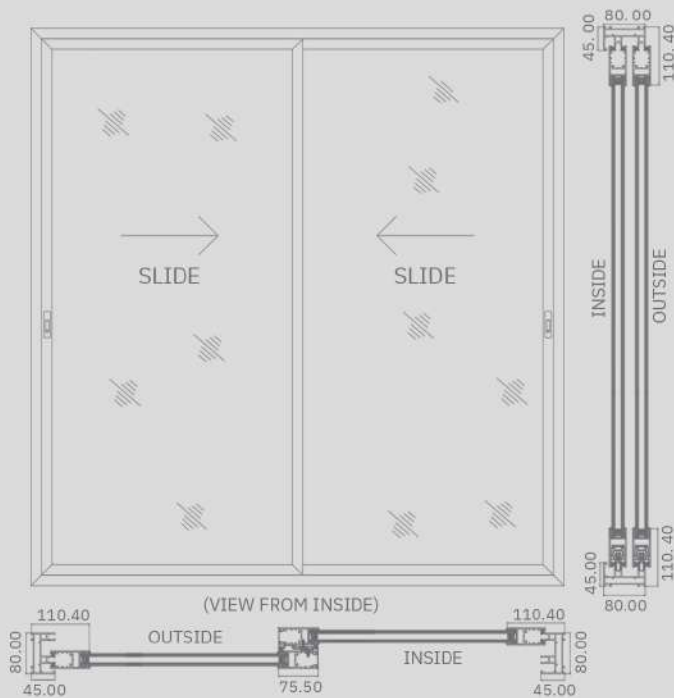
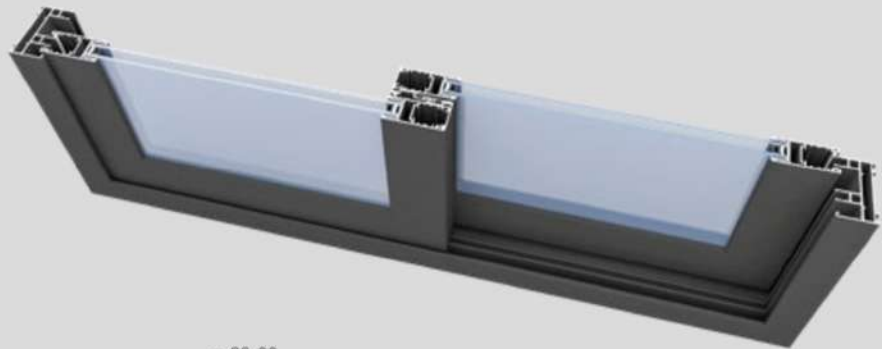

IA-91 has been exclusively designed for comfortable interiors and visual aesthetics. It is multi-functional range that can be used for diverse spaces with great technique and supreme care. It is the product for better tomorrow.

Shutter	Size 2	34 mm x 74 mm
Track	3 Track	80 mm x 45 mm
Window	Height	126 mm x 45 mm
Sash	Weight	Max. 3000 mm
Hardware		Max. 200 Kgs
Joinery	Detail	Single / Multipoint Locking
Glazing	Options	45° with corner connector
Glazing		Single / Laminated / DGU
Thickness		Min. 6 mm Max. 24 mm
Mosq.	Mesh	Tear resistant Fibre Mesh / S S 304 Safety Mesh
Finish		Powder coating (Satin / Textured finish) Wood effect powder coating



IA-92 Sleek

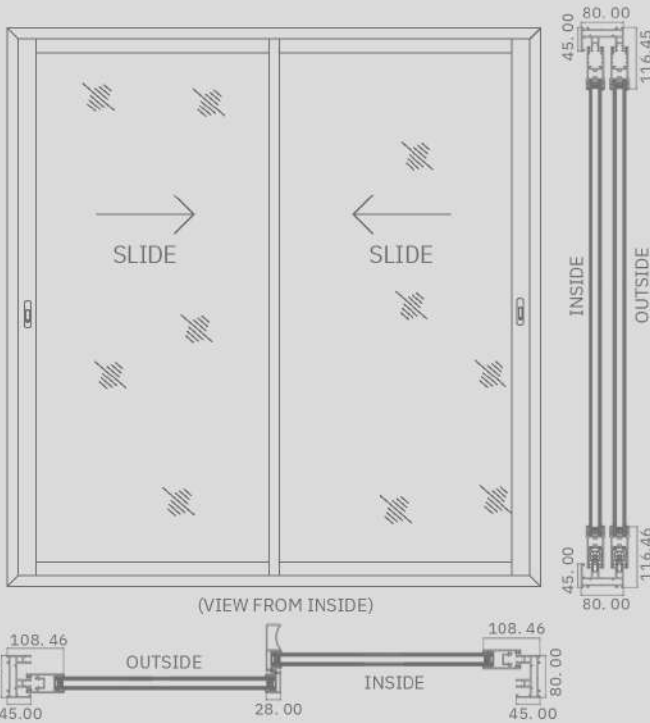

This is an ideal solution for residences, flats and commercial building offering impressive and functional results with great view. Sleek mullion minimises the impact of the window on view.

Shutter	Size	36 mm x 72 mm
Interlock	visible	28mm
2 Track	3 Track	80 mm x 45 mm
Window	Height	126 mm x 45 mm
Sash	Weight	3000 mm
Hardware		200 Kgs
Joinery	Detail	Single / Multipoint Locking
Glazing	Options	90° with screw fixing
Glazing		Single / Laminated / DGU
Thickness		Min. 5 mm Max. 24 mm
Mosq.	Mesh	Tear resistant Fibre Mesh / S S 304 Safety Mesh
Finish		Powder coating (Satin / Textured finish) Wood effect powder coating



INTELLIGENT
ALUMINIUM
itswallpanel.com

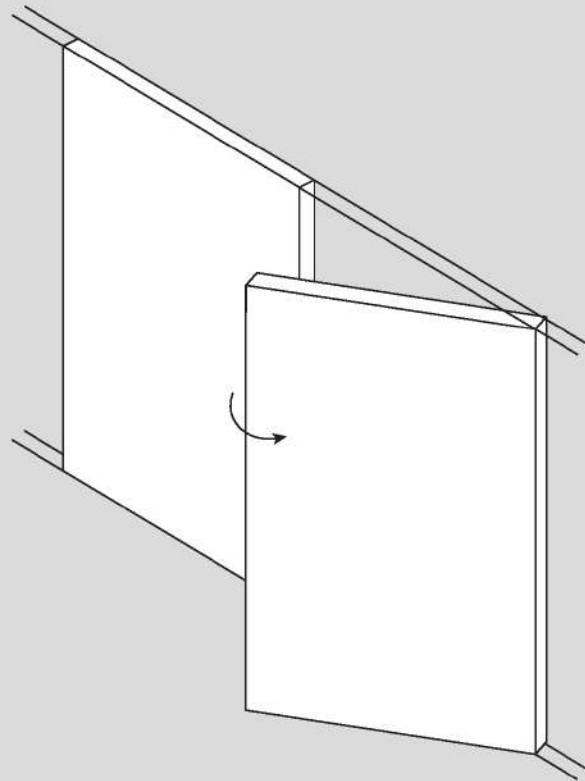

Casement Window

Casement Windows are outward opening windows.

Casement windows provide a better air tight seal and better sound insulation as compared to sliding windows. It minimizes leakage in the fenestration & improves temperature regulation from inside out and outside in. In hot and humid regions where temperature rises to a smothering 45°C in summer, it reduces the cooling loss through windows/ doors, helping in standard use of the air conditioner and maintaining the temperature and avoiding overload and repetitive use of cooling systems.

Similarly, in cold, dry climates the casement windows seals shut the warmth inside with little to no leak to the outside environment and vice versa

with the outside weather to the comfort of your room, house.

Use of Double glass (DGL) should be considered to achieve better sound and heat insulation. Bhavya aluminum provides a vast range of options of Powder Coating and Wooden finish coating for Windows to create best aesthetic combination with no surrounding interior/exterior design with compromise on function.

We always use EPDM Gasket for Air and Water tightness with Longer Life, a specially engineered wedge to withstand shutter load up to 75kgs for smooth trouble free operation.



INTELLIGENT
ALUMINIUM
itswallpanel.com

IA-11

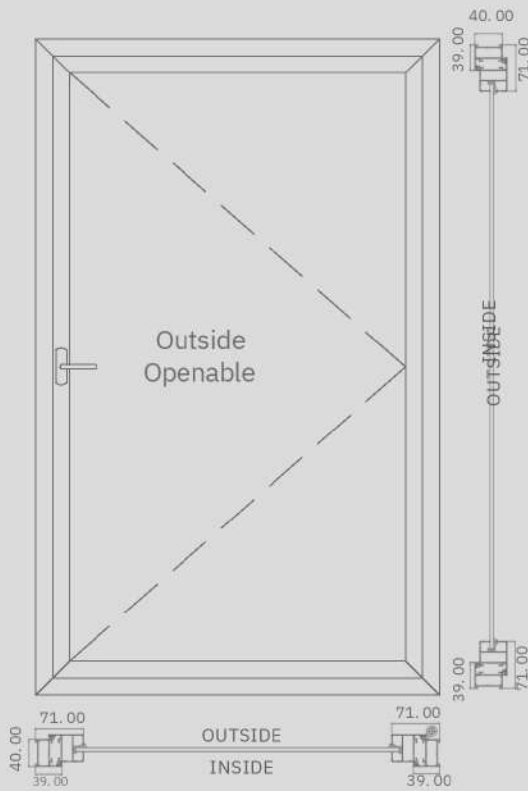
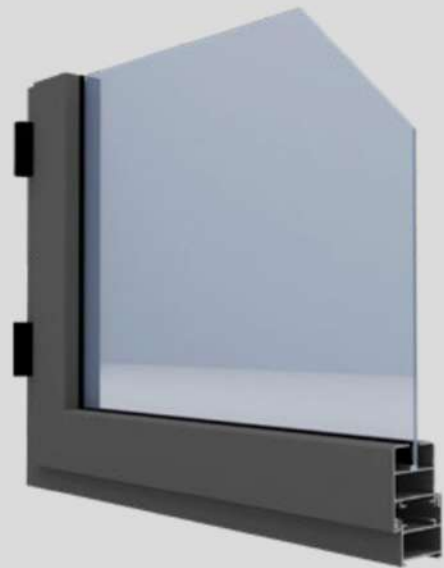

IA-11 has been designed for smaller rooms, bathrooms, powder rooms and so on. It is designed taking into consideration the opening available and the quick ventilation needed for smaller rooms.





INTELLIGENT
ALUMINIUM
itsallpanel.com

IA-12



An ideal solution for residences, apartment flats and commercial buildings. A specific design to regulate the uncertain weather, temperature and nature.

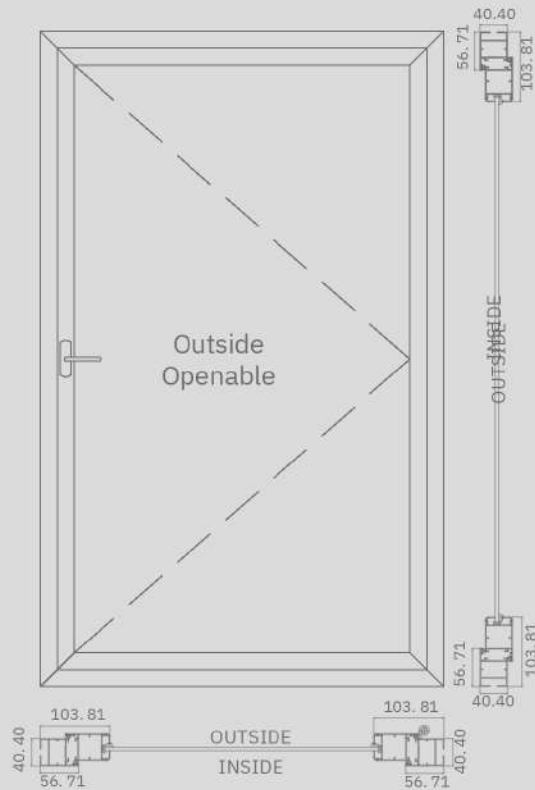

Shutter Size	40 mm x 66 mm
Frame Size	40 mm x 56 mm
Window Height	Max. 1800 mm
Sash Width	Max. 650 mm
Sash Weight Max.	50 Kgs
Hardware	Single / Multi-point Locking
Hinge	Butt Hinge / Friction Hinge
Joinery Detail	45° With corner connector
Glazing Options	Single / Laminated / DGU
Glazing Thickness	Min. 5 mm to Max. 20 mm (W/O. Glazing Clip)
Mosq. Mesh	Roll Down / Retractable
Finish	Powder coating (Satin / textured finish) Wood effect powder coating
Opening	Side Hung / Top Hung



INTELLIGENT
ALUMINIUM
itswallpanel.com

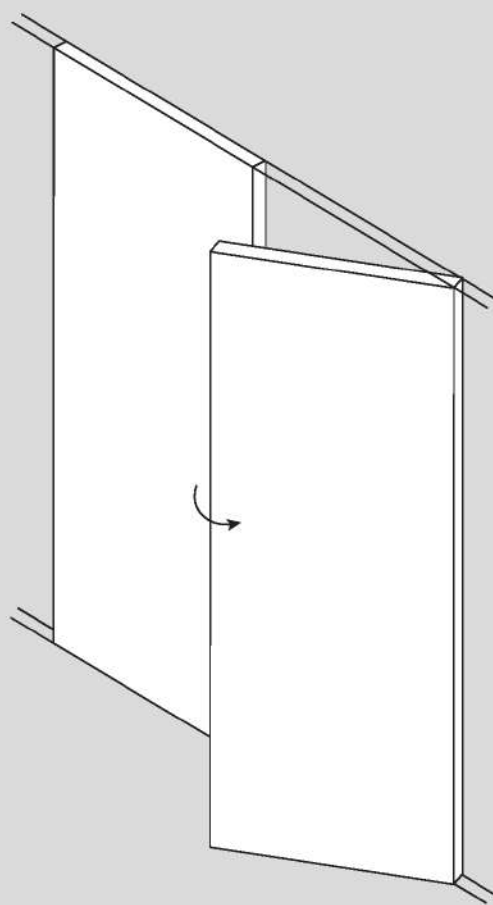

Casement Door

A door is the first welcome to your home. It also carries the last good byes.

We know the importance of memories, we always frame things we love and keep it in sight. Keeping this in mind we have crafted a range of Aluminium Doors, which not only is secure and seamless but will last you as long as the memories.

Whether you are looking for a striking, secure front entry or practical side door, we have a wide range of options that meet any unique requirements, made available in customized sizes & finishes.

Specially designed wedge is clamped along with reversible hinges to withstand shutter load up to

120 kgs for smooth trouble free operations. The bottom of our doors are sealed with a threshold or bottom sweep gasket.

We can engineer swing doors, with an option of using floor springs. Siliconized EPDM gaskets are excellent for air and water tightness. The EPDM gasket also lasts almost 10 times more than other sealants in market.

Double shutter style for swing doors to prevent dust ingress. Wide Range of colors available through Powder coating process and a variety of glazing options available. Concealed fixings for ease of installation.



INTELLIGENT
ALUMINIUM
itswallpanel.com

IA-16

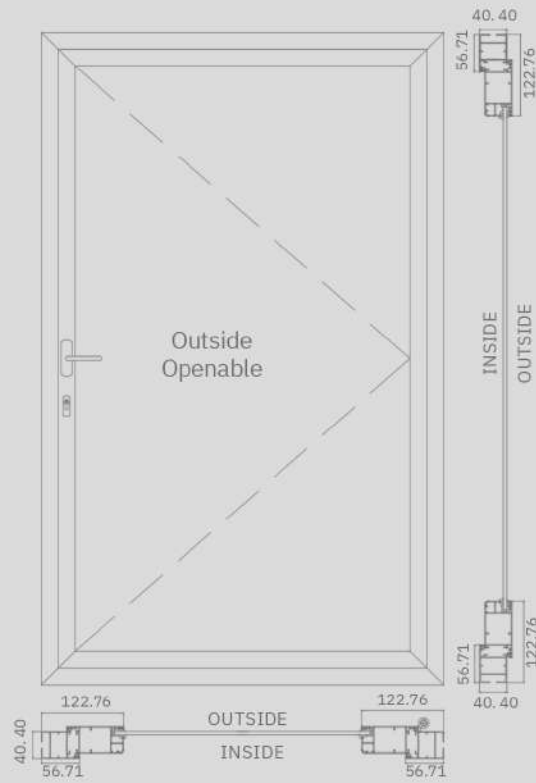

This is an ideal solution for residences, apartment flats and commercial building offering impressive looks and functional excellence.





INTELLIGENT
ALUMINIUM
itswallpanel.com

IA-17

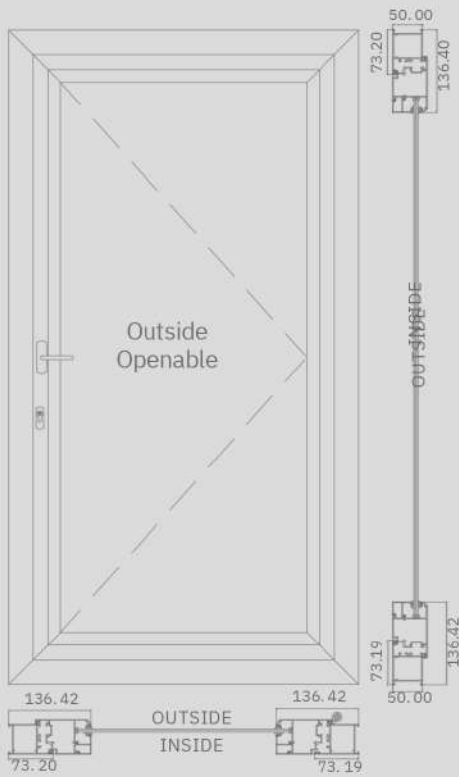
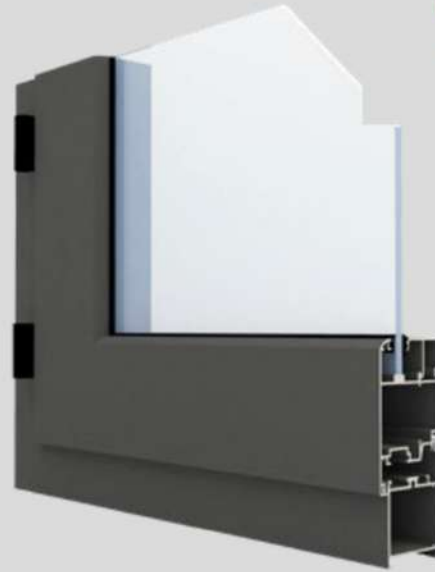

IA-17 is exclusively designed for bigger door openings and is compatible to fit safety glass and glass with integrated blinds.





INTELLIGENT
ALUMINIUM
itswallpanel.com

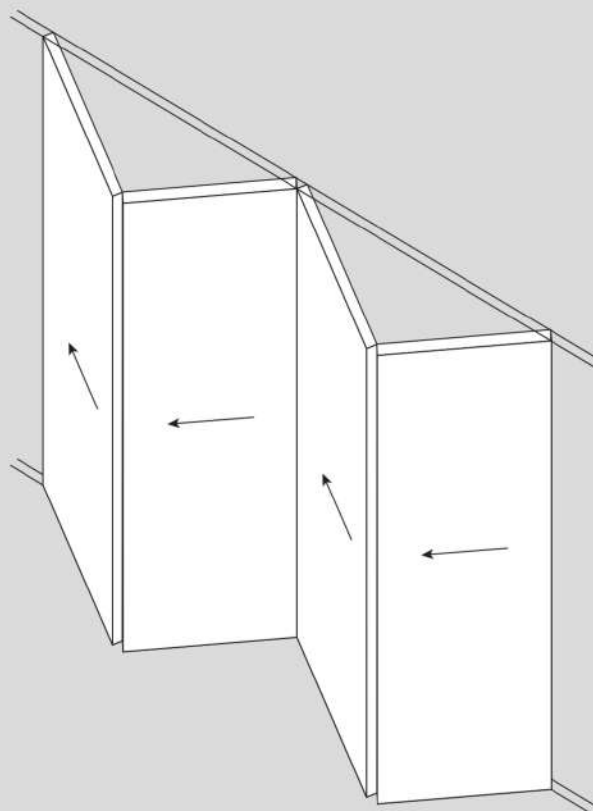

Bi-Fold Door

Bi-fold systems are the perfect way for maximum opening of your home and bringing it close to nature. At Intelligent Aluminium we have engineered doors and outstanding performance. Our bi-fold system and manufactured aluminium Bi-fold known for its reliability, design

expand your living area by opening of doors and folding on the walls aside. It occupies minimum space by folding onto one another. With this, you can create a panorama opening without any visual obstruction.

IA-61

Glass Options : 8 mm - Single Glaze, 26 mm - Double Glaze, 11.52 mm - Laminated, 30 mm with Integrated blinds.

We try and achieve the maximum integration in style by using modern and seamless options to color/ anodize / galvanize your door.

Opens outside, saving space on the inside. Wide range of handles, locks and accessories to make it a perfect fit for the design. Uniquely designed handle option.

Stylish and reliable concealed sliding mechanism. High performance as standard.

Shutter Width	70 mm 70 mm Max. 3000 mm 45°
Frame Width	cut with corner connector High
Door Height	quality Powder coating and
Corner Details	wood finish with specific
Finish	performance quarantine.

Optional Mosquito mesh





INTELLIGENT
ALUMINIUM
itswallpanel.com



Features



Sound resistant interlocks with double sealing



Designed for torrential weather conditions



Sturdy shutter joinery with plastic inserts



Sturdy and leak-proof frame joinery
F



Solid aluminium extruded track



Gated Drainage



INTELLIGENT
ALUMINIUM
itsalpanel.com

Custom Variations

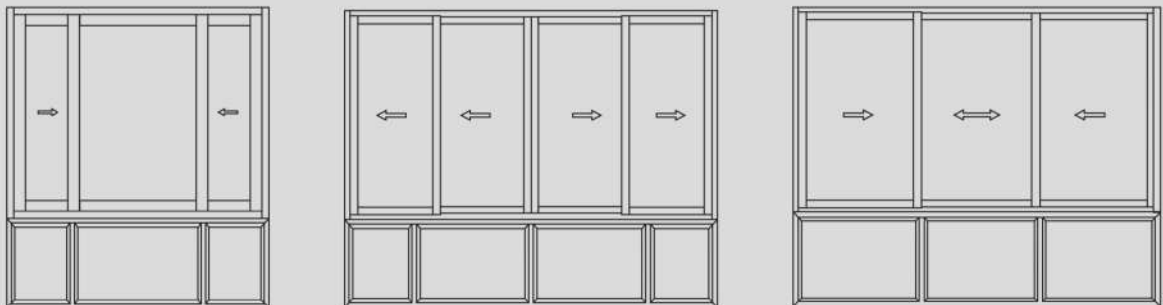
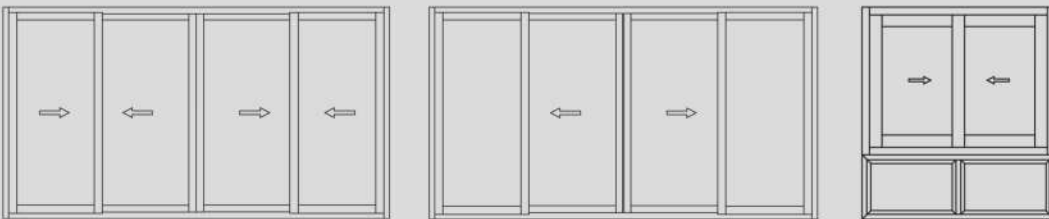
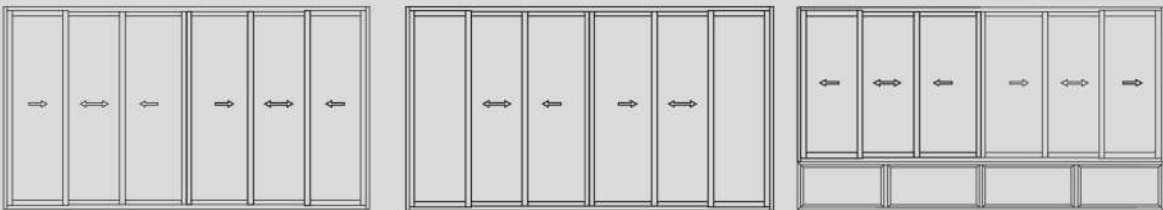
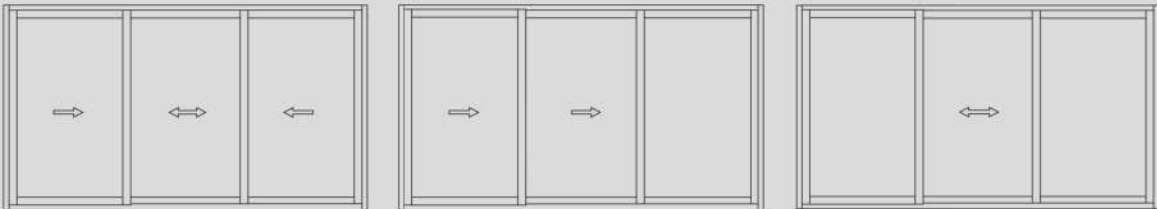
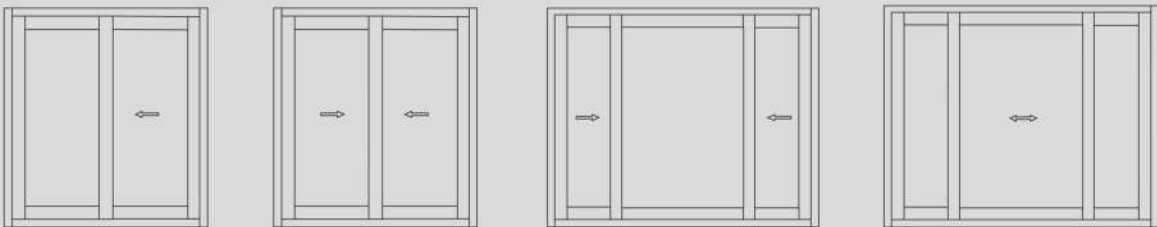

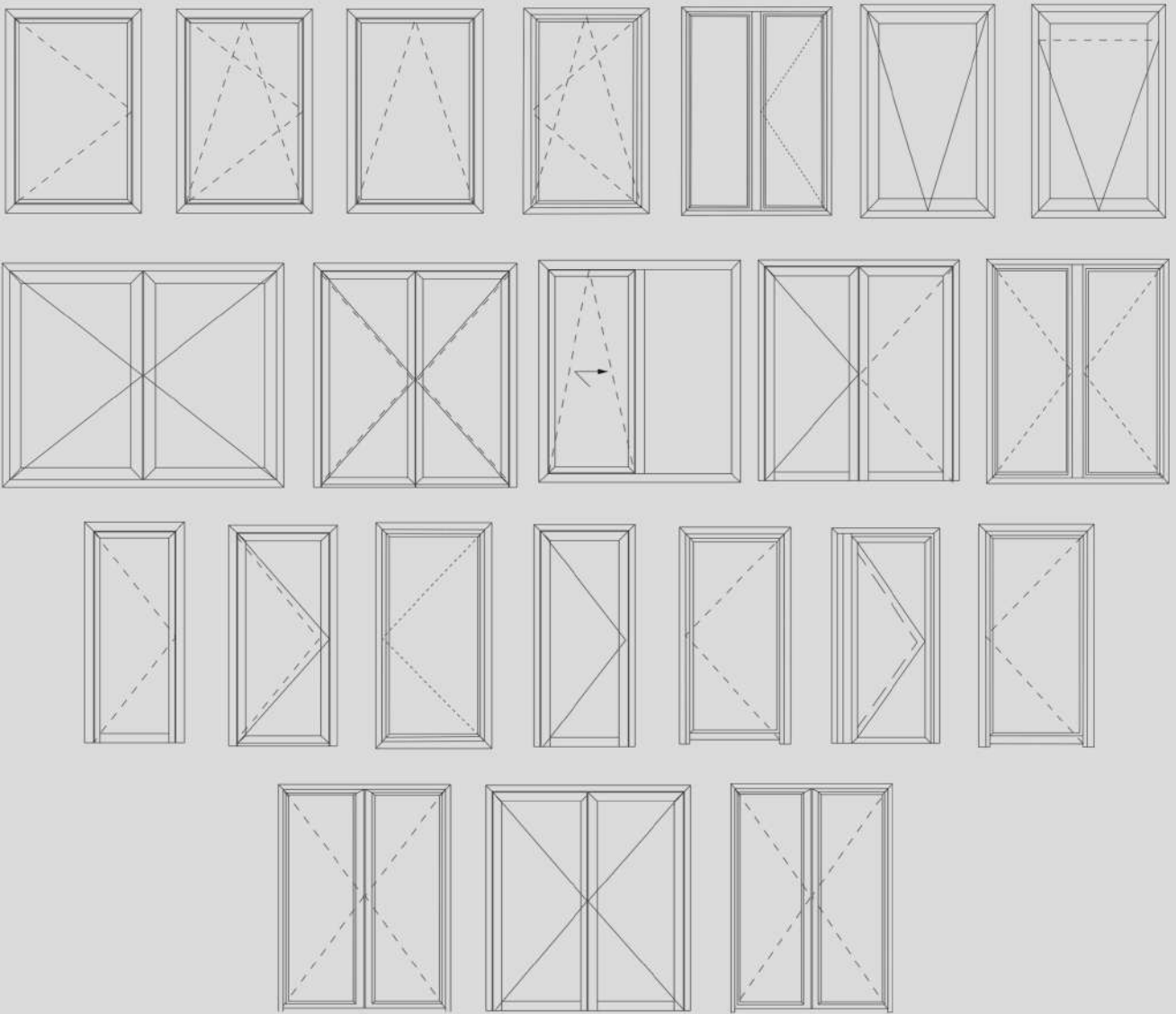



INTELLIGENT
ALUMINIUM
itswallpanel.com

Modal Series

Eco - Sliding

With a minimalistic design, Smile sliding series offers an aesthetic solution for the architectural building. It has a wide range of opening styles based on double or triple track windows.



All accessories are sourced from leading suppliers in Europe



Our hardware and profiles are tested based on EU norms to provide the strictest and highest standards



All windows are equipped with a special drain cap to handle stormy weather



Features



Flush Interlock

Seamless interlock with no visible overlapping profile and complete insect seal.



Automatic Lock

Automatic handle adjusted to perfection to ensure the long operational life of the lock.



Functional Design

the corner joint is insured without our automated clamping machine.



Flymesh

Keep your window open for ventilation without letting mosquitoes enter your home.



Door Stopper

Bumper present to avoid violent shocks between window.



Corner Piece

Anti-lift to prevent burglar intrusion and guide accessory to ensure smooth sliding.





Technical Specifications

MODAL SLIDING WINDOWS & DOORS

Variant		2 Track with mesh	2 Track with mesh & Cill	3 Track with mesh
System Size	Outer frame width	66mm	76.6mm	99mm
Visible dimensions	Vent Width	26.0mm		
	Outer frame height	38.8mm		
	Handle section	51.2mm		
	Top/Bottom section depth	53.5mm		
	Interlock section depth	30.9mm		
Profiles				
Aluminium	Alloy 6063-T4/T5/T6			
Wall Thickness	Minimum profile thickness 1.1mm - 1.5mm			
Glazing				
Glass thickness Single Glazing	5mm, 6mm, 8mm			
Sealing	All glass glazing with EPDM, Sliding with brush seals			
Assembly Specifications				
Corner connection Frame				
Corner connection Shutter	90 overlapping			
Design Specifications				
Bug Mesh	Glass reinforced fibre mesh/stainless steel(optional)			
Hardware	Single point locking			
Color	Profile finish in RAL powder coating			

Finishes

The look of your house, with more than 1500 RAL finishes in vibrant colors and panels of different pattern like gloss and matte finishes, pastel shades, metallic and anodized colors & also wood grain finish, you have a classy pick for your windows or doors.



WOOD GRAIN FINISH



RAL FINISH



Possible Variations



Modal Window

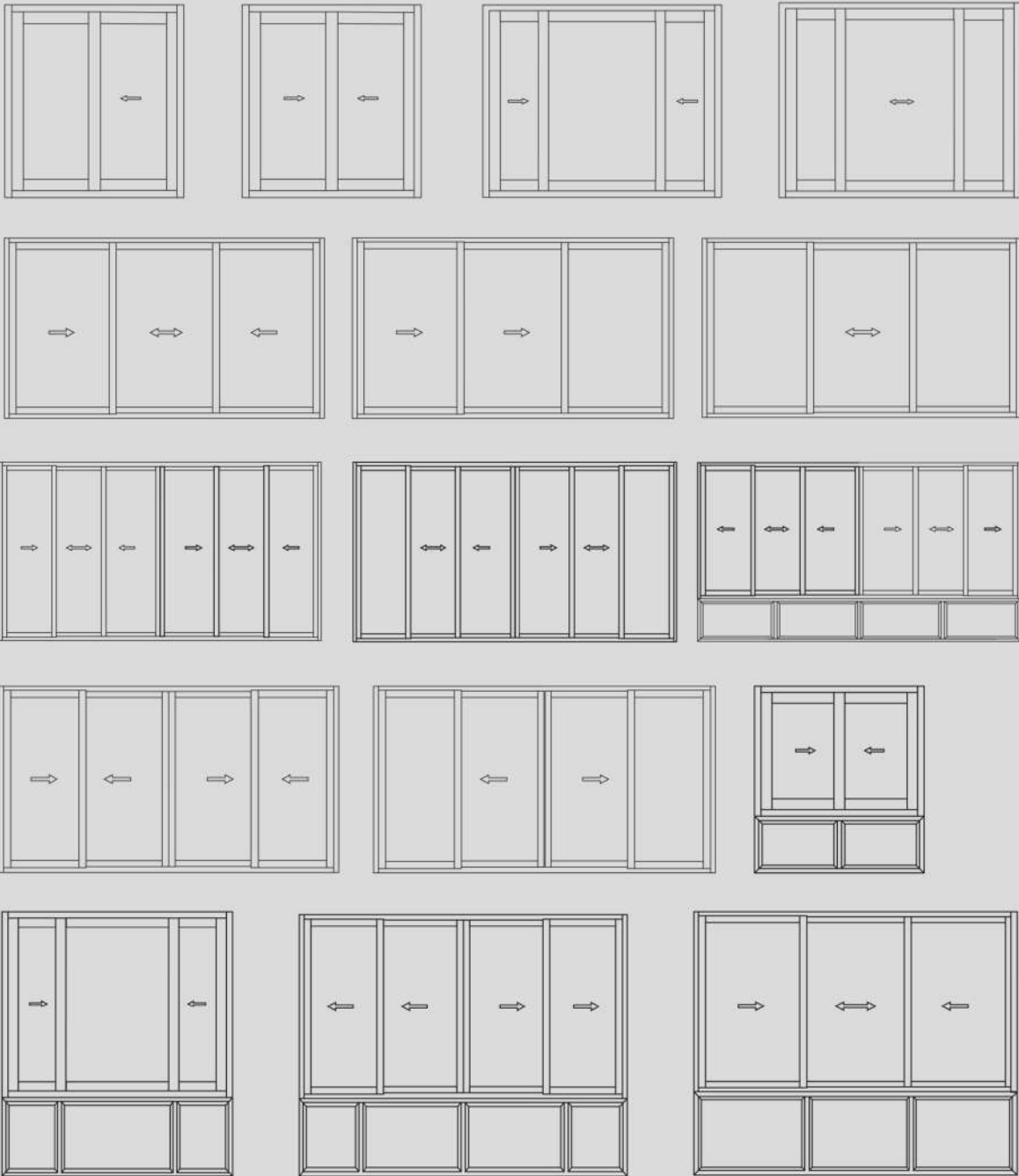



Pleated Mesh

Easy to use and easier to maintain, these are some of the finest screens that pair seamlessly with Slimline Windows and Doors.



Keeps mosquitoes and tiny insects out



Magnetic Locking



Re-inforced to avoid buckling or bending

Hardware



INTELLIGENT
ALUMINIUM

itswellpanel.com



HEIFEL



CCI



KUBIK



552



COIE



2870



2701



ZED10000S



NOVEM-OFFSET



3010



MIA



FAI



2870



NOVEM-STANDARD



1534



COSI

More Than
50 handles
and locks to
pick from.

Window Ventilation solutions



INVISIVENT EVO

The most discrete, self-regulating over frame flap ventilator



ENDURA TWIST

Fresh air supply unit with Filters



THM90 EVO

Flat, thermally broken self-regulating window ventilator



THL 100 V

Vertical sliding vent



Air-tight and discreetly located



Fresh air at all times



Suits every interior



Sturdy and strongly built



Control the heat of the sun and avoid overheating.

This external roller blind offers the best in quality, design and easy installation ensuring that the screen is windproof in any position. Flapping and torn fabrics are now a thing of the past. The new aluminium endcaps provide extra stability and can be coated in the same colour as the profiles.

Extremely wind-proof screen

Insect repellent

Silent operation

Simple maintenance

Large dimensions (up to 22m²)

130 km/h windproof and rain proof





INTELLIGENT
ALUMINIUM
itswallpanel.com

Finishes

MyWindow presents a large variety of colors and finishes accentuating the look of your house, with more than 1500 RAL finishes in vibrant colors and panels of different patterns like gloss and matte finishes, pastel shades, metallic and anodized colors & also wood grain finish, you have a classy pick for your windows or doors.



WOOD GRAIN
FINISH



RAL
FINISH



AkzoNobel

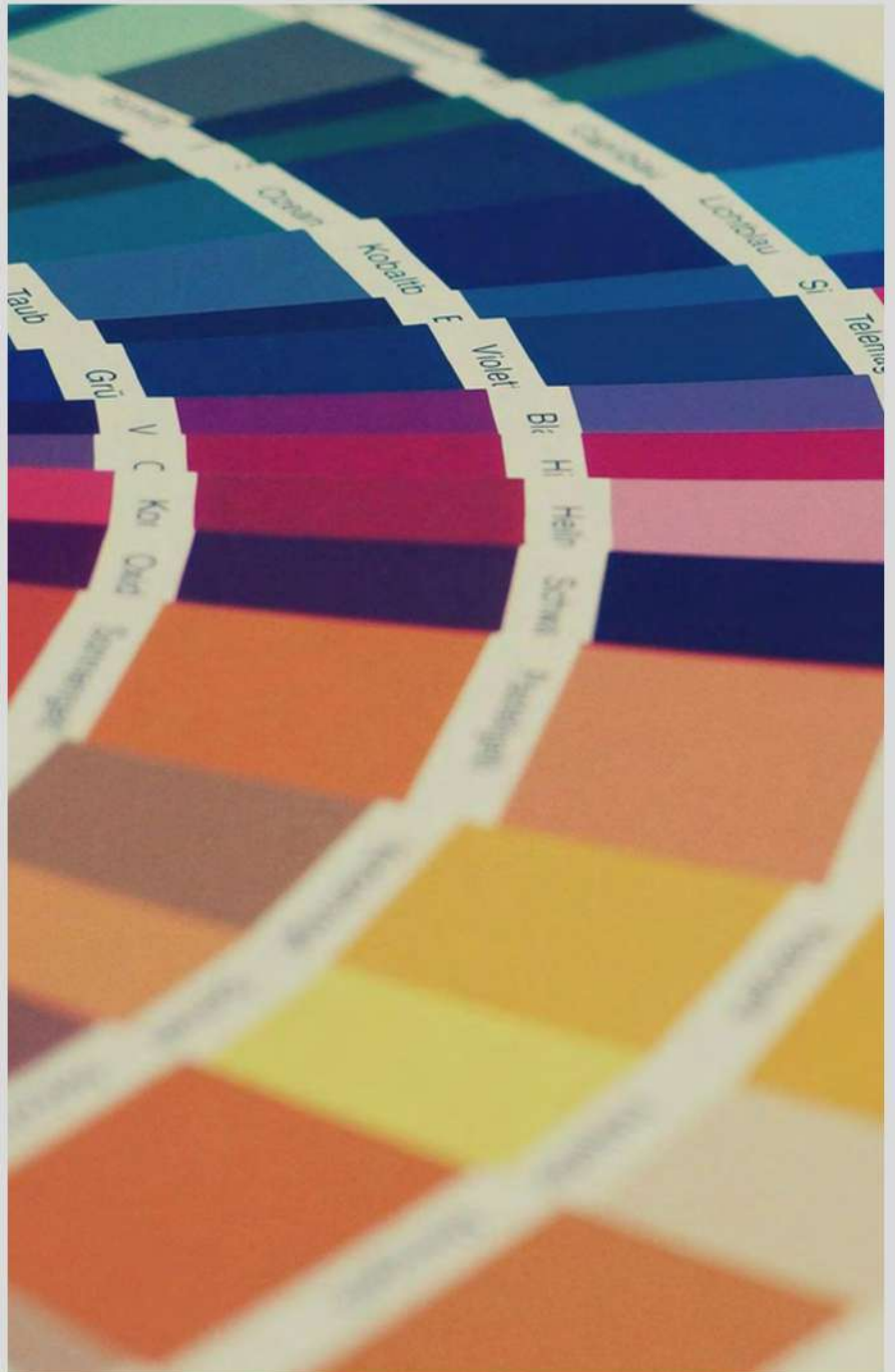

*Colors are for illustration purpose only.
Please refer to the paint chips for accurate color matching



SLIM

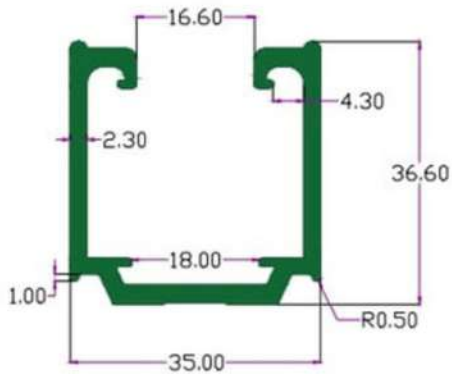

SEC.NO. 4363
Wt. 2.850 TO 3.000 KG./ 12'

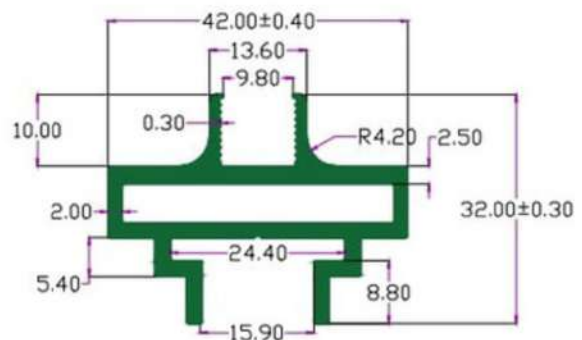

SEC.NO. 4364
Wt. 3.130 TO 3.350 KG./ 12'

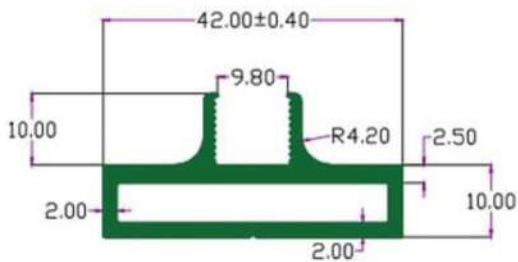

SEC.NO. 4365
Wt. 2.400 TO 2.650 KG./ 12'

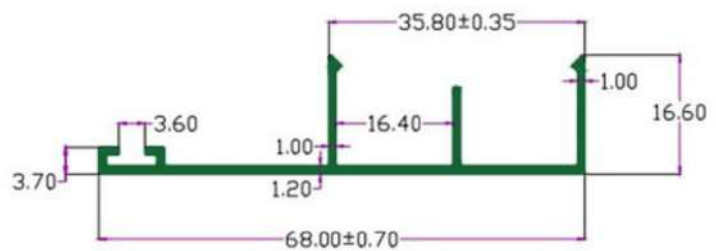

SEC.NO. 4366
Wt. 1.300 TO 1.450 KG./ 12'

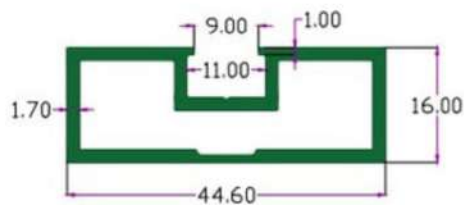

SEC.NO. 4429(K.I)
Wt. 2.120 TO 2.300 KG./ 12'

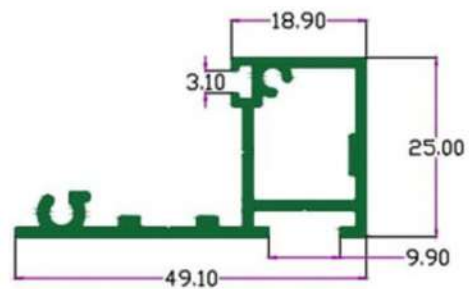

SEC.NO. 4467
Wt. 9.160 TO 9.350 KG./ 12'

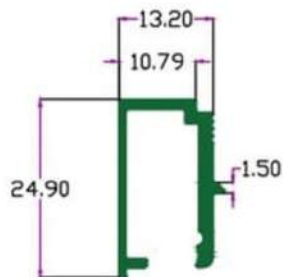

SEC.NO. 4468
Wt. 0.860 TO 0.100 KG./ 12'

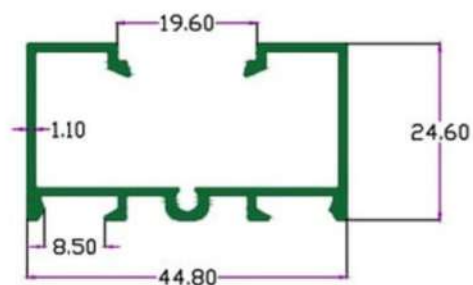

SEC.NO. 4508
Wt. 1.580 TO 1.700 KG./ 12'



SLIM

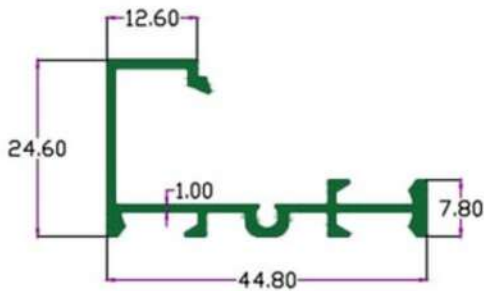

SEC.NO. 4509

Wt. 1.300 TO 1.500 KG./ 12'

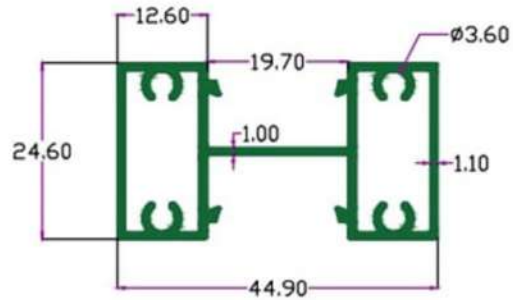

SEC.NO. 4510

Wt. 2.200 TO 2.450 KG./ 12'

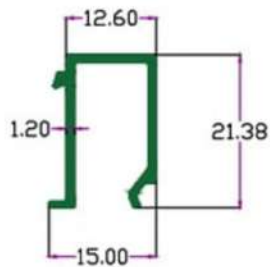

SEC.NO. 4511

Wt. 0.650 TO 0.850 KG./ 12'

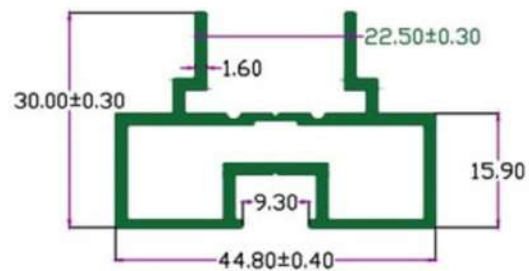

SEC.NO. 4529

Wt. 2.350 TO 2.500 KG./ 12'

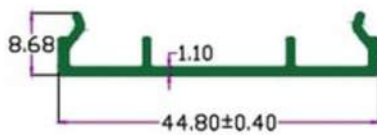

SEC.NO. 4531

Wt. 0.750 TO 0.850 KG./ 12'

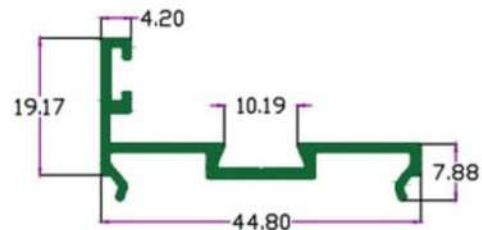

SEC.NO. 4544

Wt. 1.170 TO 1.270 KG./ 12'

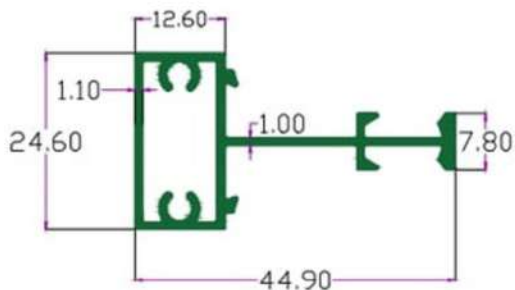

SEC.NO. 4572

Wt. 3.280 TO 3.350 KG./ 12'

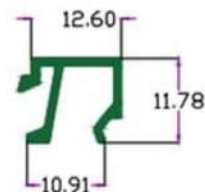

SEC.NO. 4573

Wt. 0.450 TO 0.550 KG./ 12'



SLIM

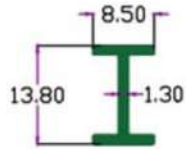

SEC.NO. 4764
Wt. 0.360 TO 0.460 KG./ 12'

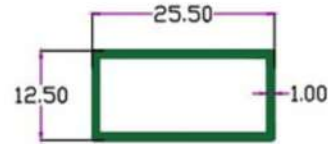

SEC.NO. 4779
Wt. 0.700 TO 0.800 KG./ 12'

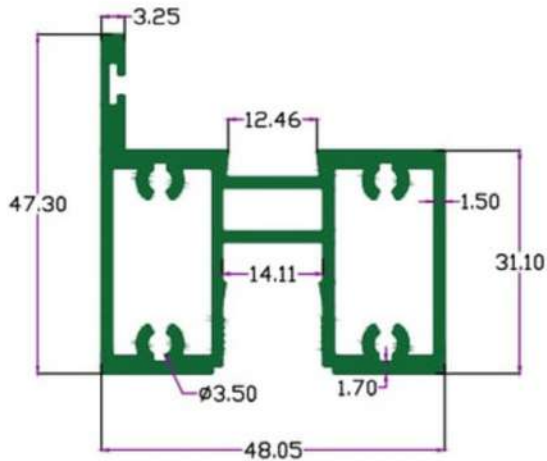

SEC.NO. 4817
Wt. 4.550 TO 4.800 KG./ 12'

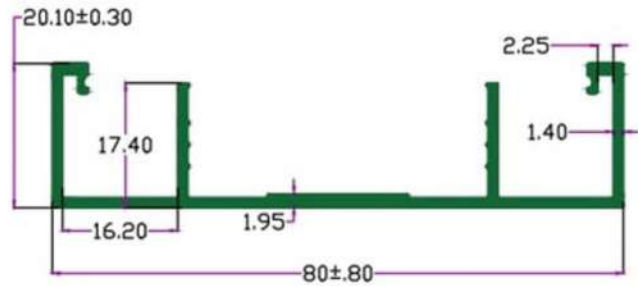

SEC. NO. 3770
Wt. 2.30 TO 2.70 KG / 12'

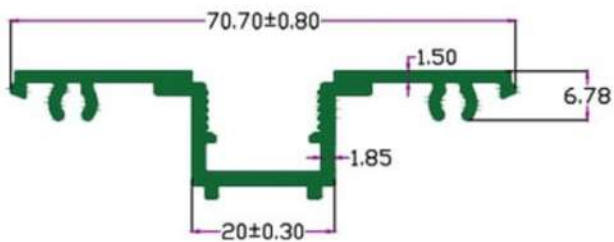

SEC. NO. 3771
Wt. 2.20 TO 2.50 KG / 12'

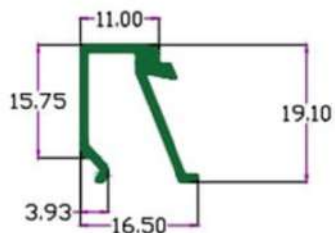

SEC. NO. 3773
Wt. 0.60 TO 0.80 KG / 12'

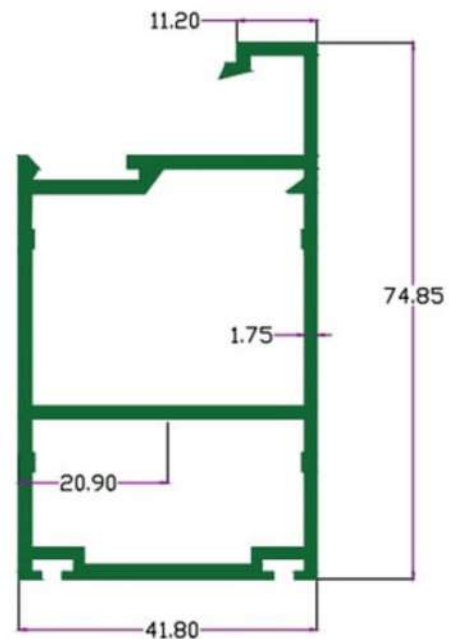

SEC. NO. 3772
Wt. 4.80 TO 5.10 KG / 12'



SLIM

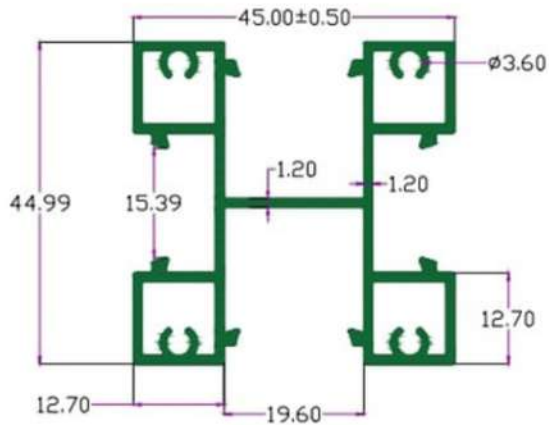

SEC.NO. 4656
Wt. 3.450 TO 3.620 KG./ 12'

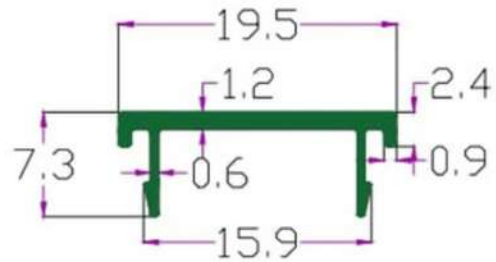

SEC.NO. 4657
Wt. 0.330 TO 0.500 KG./ 12'

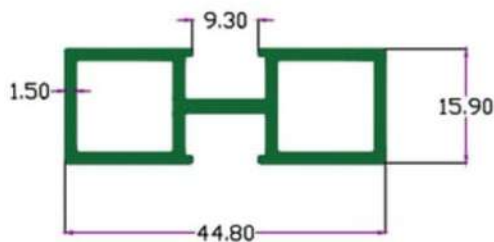

SEC.NO. 4685
Wt. 2.000 TO 2.200 KG./ 12'

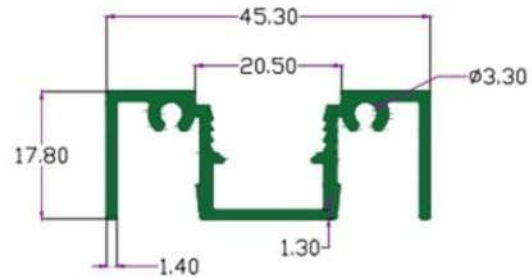

SEC.NO. 4691
Wt. 1.830 TO 2.050 KG./ 12'

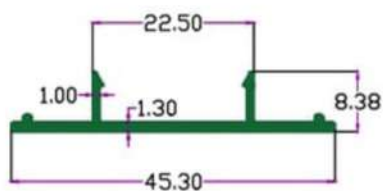

SEC.NO. 4692
Wt. 0.740 TO 0.850 KG./ 12'

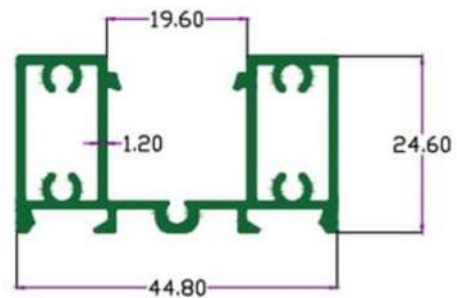

SEC.NO. 4699
Wt. 2.220 TO 2.470 KG./ 12'

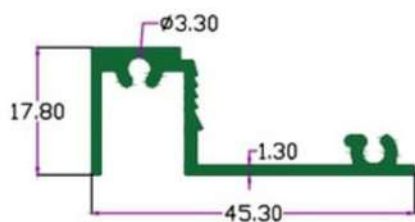

SEC.NO. 4715
Wt. 1.330 TO 1.490 KG./ 12'

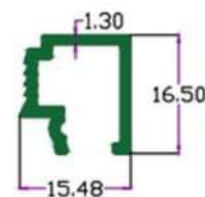

SEC.NO. 4716
Wt. 0.700 TO 0.820 KG./ 12'



INTELLIGENT
ALUMINIUM
itwalpanel.com

SLIM

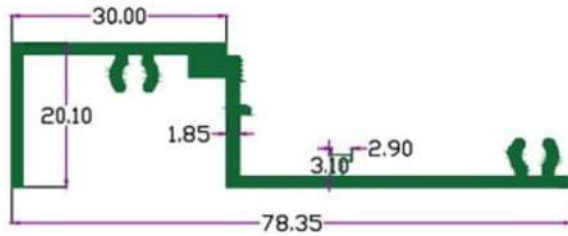

SEC. NO. 3774
Wt. 2.25 TO 2.50 KG / 12'

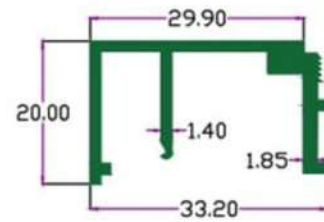

SEC. NO. 3775
Wt. 1.35 TO 1.50 KG / 12'

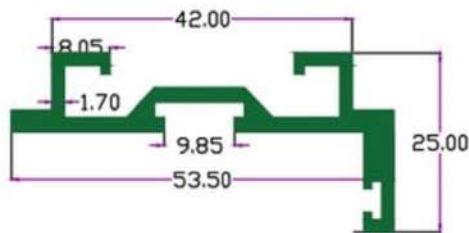

SEC. NO. 3776
Wt. 2.35 TO 2.50 KG / 12'

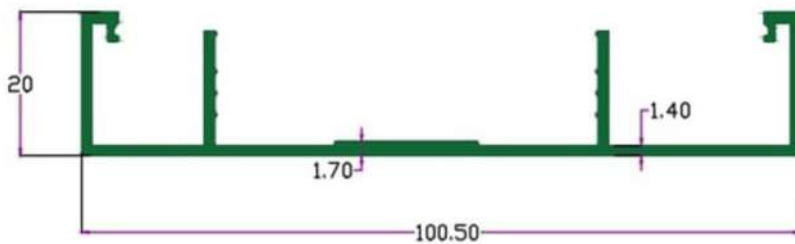

SEC. NO. 3897
Wt. 2.500 TO 2.800 KG. / 12'

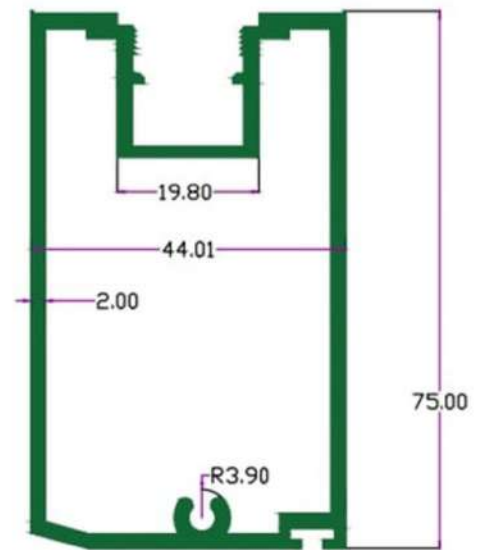

SEC. NO. 3777
Wt. 5.50 TO 5.80 KG / 12'

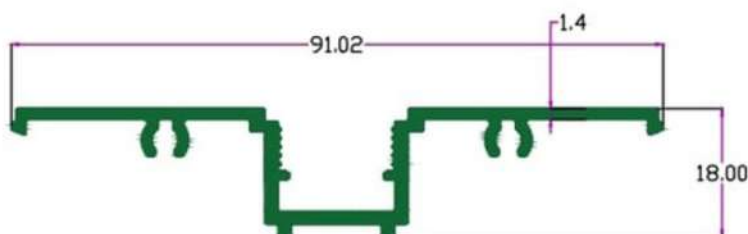

SEC. NO. 3898
Wt. 2.400 TO 1.700 KG. / 12'



INTELLIGENT
ALUMINIUM
itwalpanel.com

SLIM

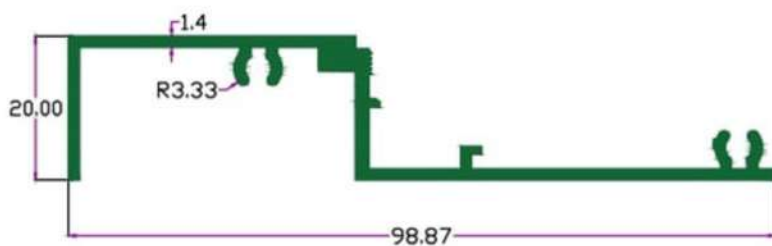

SEC. NO. 3899
Wt.2.400 TO 1.700 KG./ 12'

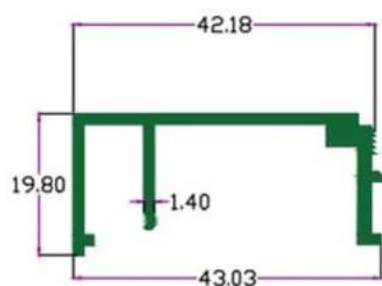

SEC. NO. 3900
Wt.1.400 TO 1.800 KG./ 12'

DOMAL / CASEMENT



INTELLIGENT
ALUMINIUM
itwalpanel.com

30MM CASEMENT SECTIONS

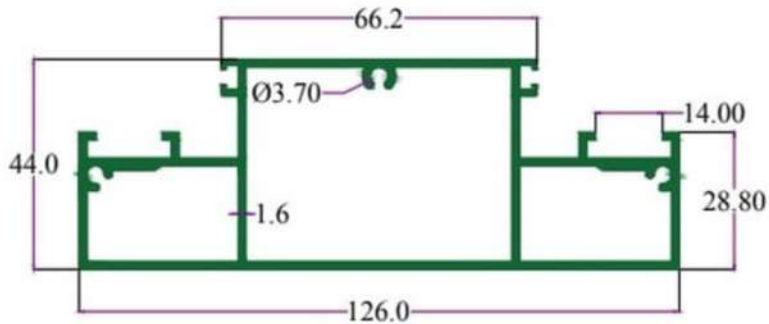

SEC. NO. 3527
WT. 7.100 TO 7.900 KG / 12'

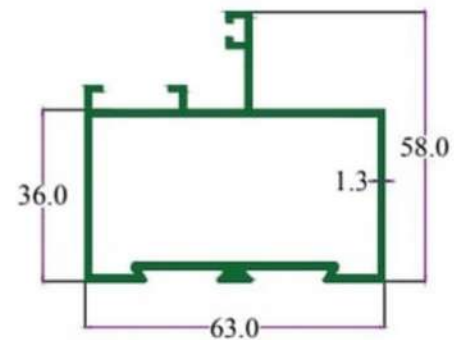

SEC. NO. 3530
WT. 3.100 TO 3.500 KG / 12'

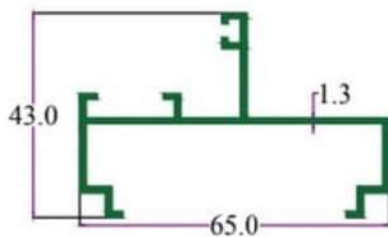

SEC. NO. 3528
WT. 2.050 TO 2.300 KG / 12'

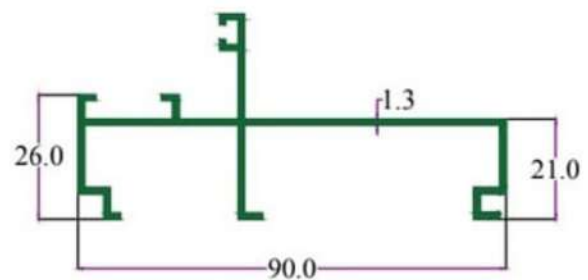

SEC. NO. 3529
WT. 2.700 TO 3.000 KG / 12'

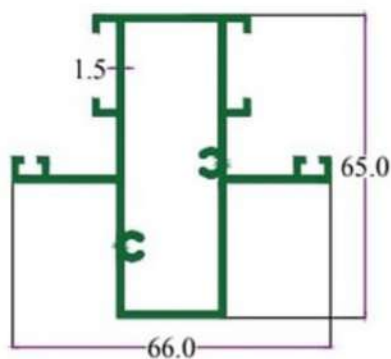

SEC. NO. 3531
WT. 3.800 TO 4.200 KG / 12'

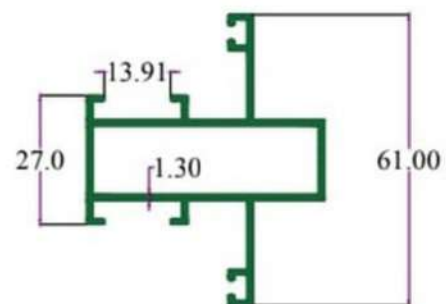

SEC. NO. 3521
WT. 3.000 TO 3.300 KG / 12'

DOMAL / CASEMENT



INTELLIGENT
ALUMINIUM
itwalpanel.com

30MM CASEMENT SECTIONS

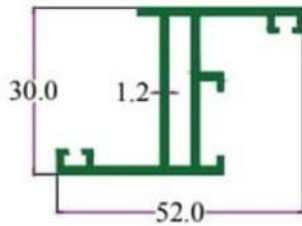

SEC. NO. 3523
WT. 1.650 TO 1.850 KG / 12'

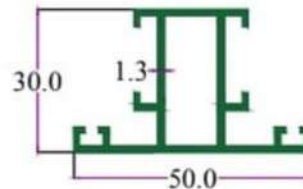

SEC. NO. 3524
WT. 1.900 TO 2.200 KG / 12'

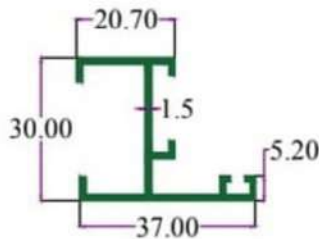

SEC. NO. 3522
WT. 1.550 TO 1.750 KG / 12'

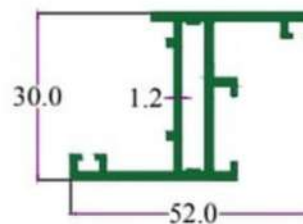

SEC. NO. 3525
WT. 1.650 TO 1.850 KG / 12'

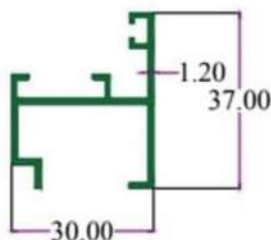

SEC. NO. 3994
WT. 1.300 TO 1.600 KG./12'

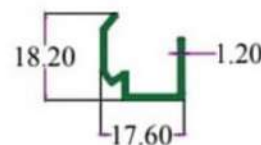

SEC. NO. 3995
WT. 0.500 TO 0.700 KG./12'

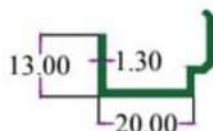

SEC. NO. 3526
WT. 0.630 TO 0.710 KG/12'

DOMAL / CASEMENT



INTELLIGENT
ALUMINIUM
itwalpanel.com

27MM SLIDING WINDOWS

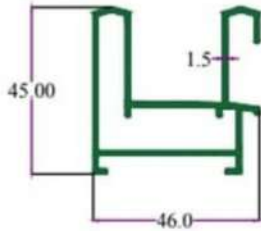

SEC. NO. 3313
WT. 3.270 TO 3.550 KG./ 12'

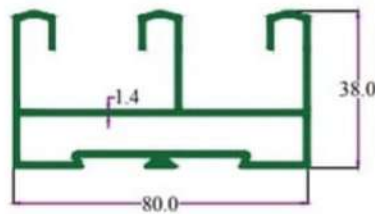

SEC. NO. 3316
WT. 4.290 TO 4.500 KG./ 12'

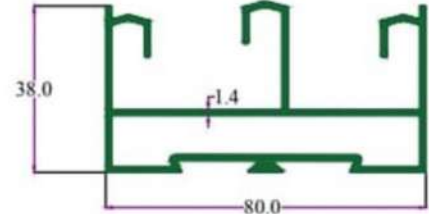

SEC. NO. 3314
WT. 4.30 TO 4.50 KG./ 12'

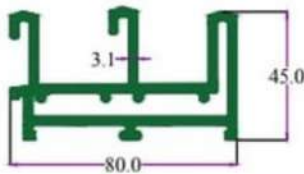

SEC. NO. 3694
WT. 9.60 TO 10.60 KG / 12'

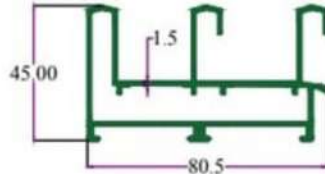

SEC. NO. 3311
WT. 5.200 TO 5.400 KG./ 12'

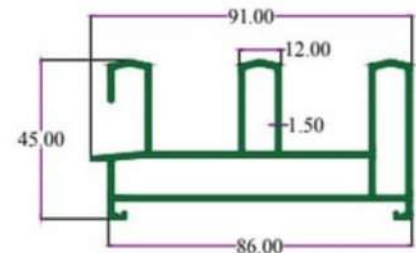

SEC. NO. 4272
WT. 5.750 TO 6.100 KG./ 12'

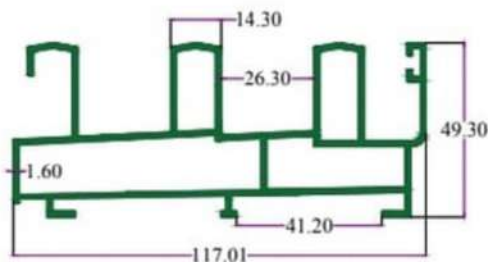

SEC. NO. 3320
WT. 8.000 TO 8.250 KG./ 12'

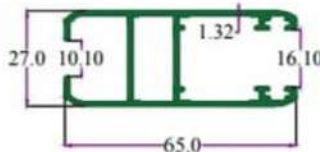

SEC. NO. 3315
WT. 2.720 TO 3.000 KG./12'

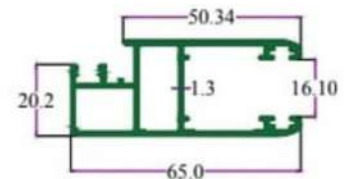

SEC. NO. 3331
WT. 3.100 TO 3.400 KG./ 12'



SEC. NO. 3695
WT. 5.750 TO 6.100 KG./ 12'

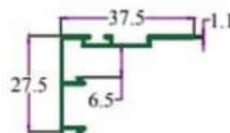

SEC. NO. 3312
WT. 0.940 TO 1.110 KG./12'

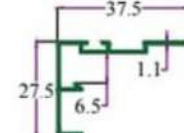

SEC. NO. 3312
WT. 0.940 TO 1.100 KG./ 12'

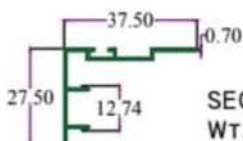

SEC. NO. 4421
WT. 0.600 TO 0.850 KG./ 12'

DOMAL / CASEMENT



INTELLIGENT
ALUMINIUM
itwalpanel.com

37MM SLIDING WINDOWS

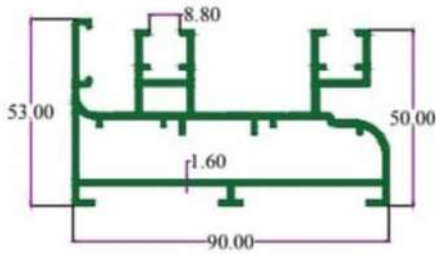

SEC. NO. 4706
WT. 6.700 TO 6.950 KG. / 12'

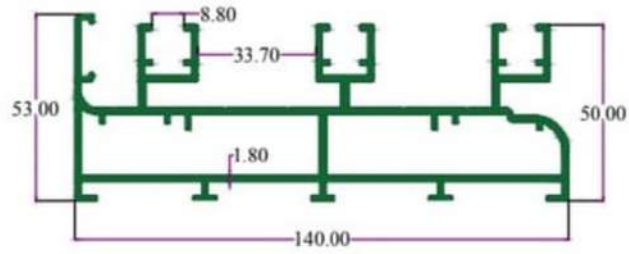

SEC. NO. 4707
WT. 10.540 TO 10.800 KG. / 12'

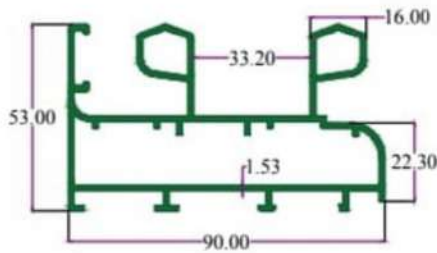

SEC. NO. 4712
WT. 6.440 TO 6.620 KG. / 12'

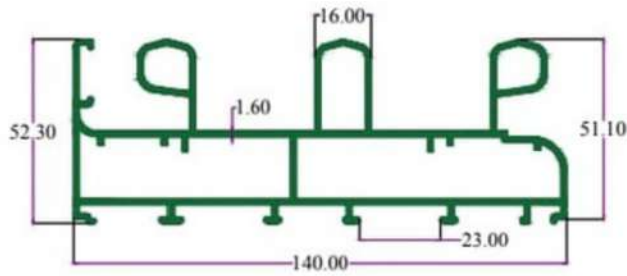

SEC. NO. 4713
WT. 9.810 TO 10.120 KG. / 12'

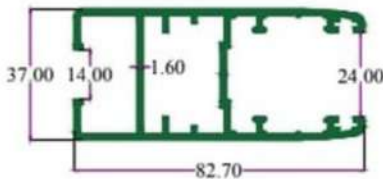

SEC. NO. 4708
WT. 4.860 TO 5.050 KG. / 12'

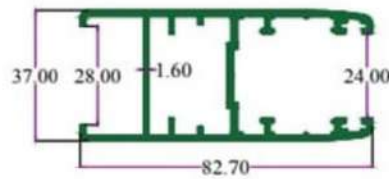

SEC. NO. 4709
WT. 4.610 TO 4.850 KG. / 12'

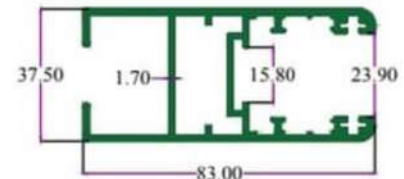

SEC. NO. 4748
WT. 5.240 TO 5.500 KG. / 12'

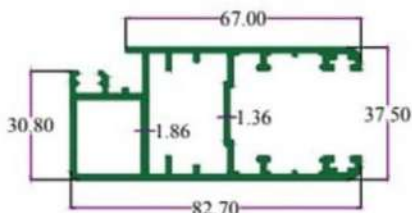

SEC. NO. 4711
WT. 4.820 TO 5.050 KG. / 12'

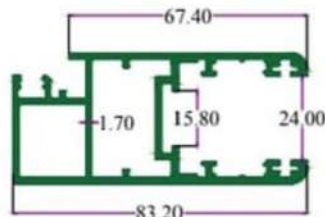

SEC. NO. 4747
WT. 5.700 TO 5.950 KG. / 12'

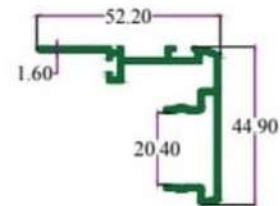

SEC. NO. 4710
WT. 2.420 TO 2.610 KG. / 12'

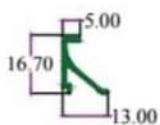

SEC. NO. 4717
WT. 0.420 TO 0.550 KG. / 12'

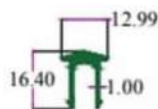

SEC. NO. 4705
WT. 0.550 TO 0.650 KG. / 12'

DOMAL / CASEMENT



INTELLIGENT
ALUMINIUM
itwalpanel.com

29MM SLIDING WINDOWS

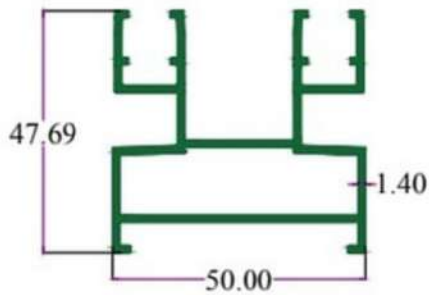

SEC.NO. 4928
WT. 3.600 TO 3.900 KG./ 12'

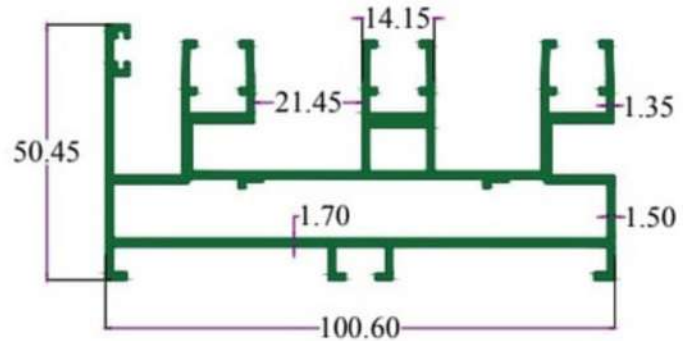

SEC.NO. 4927
WT. 7.615 TO 7.915 KG./ 12'

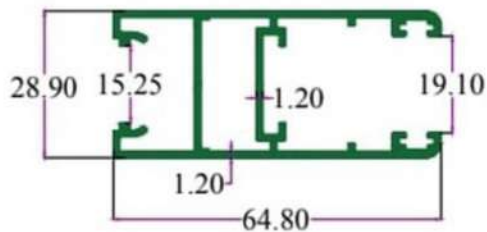

SEC.NO. 4924
WT. 2.990 TO 3.300 KG./ 12'

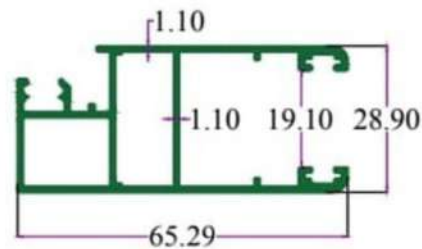

SEC.NO. 4925
WT. 2.750 TO 3.050 KG./ 12'

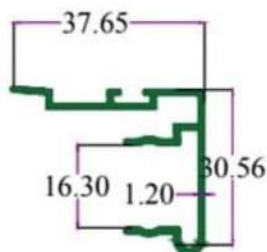

SEC.NO. 4926
WT. 1.310 TO 1.450 KG./ 12'

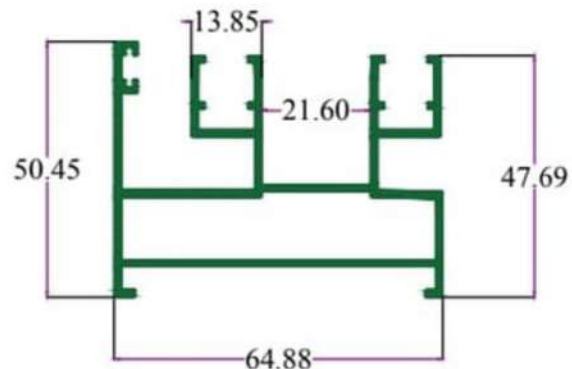

DOMAL / CASEMENT



INTELLIGENT
ALUMINIUM
itwalpanel.com

32MM SLIDING WINDOWS

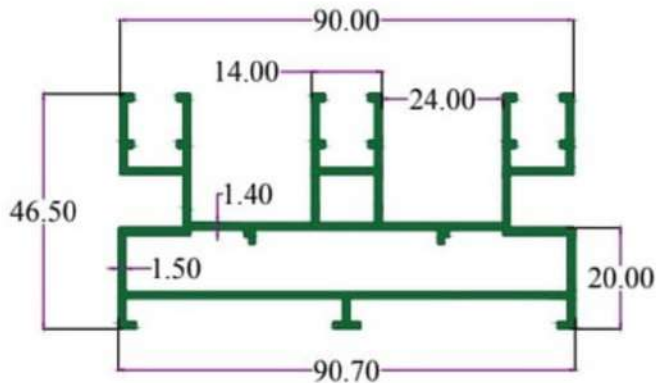

SEC.NO. 4888
WT. 5.900 TO 6.150 KG./ 12'

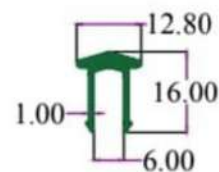

SEC.NO. 4890
WT. 0.555 TO 0.660 KG./ 12'

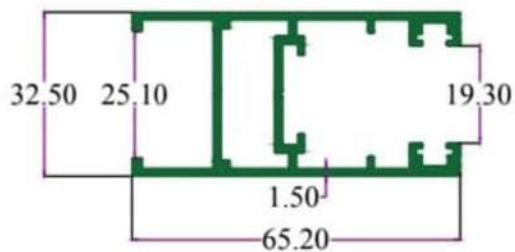

SEC.NO. 4889
WT. 3.700 TO 3.900 KG./ 12'

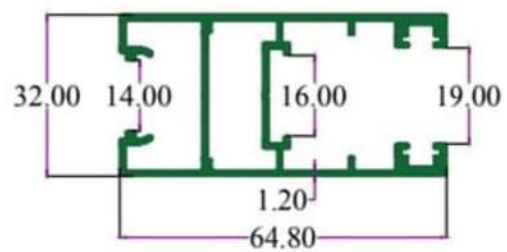

SEC.NO. 4892
WT. 3.360 TO 3.560 KG./ 12'

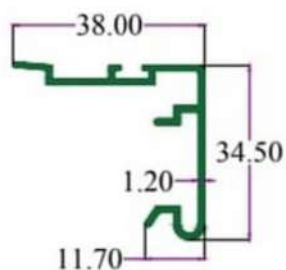

SEC.NO. 4891
WT. 1.230 TO 1.380 KG./ 12'

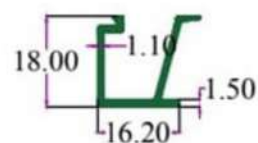

SEC.NO. 4893
WT. 0.580 TO 0.680 KG./ 12'

DOMAL / CASEMENT



INTELLIGENT
ALUMINIUM
itwalpanel.com

32MM SLIDING WINDOWS

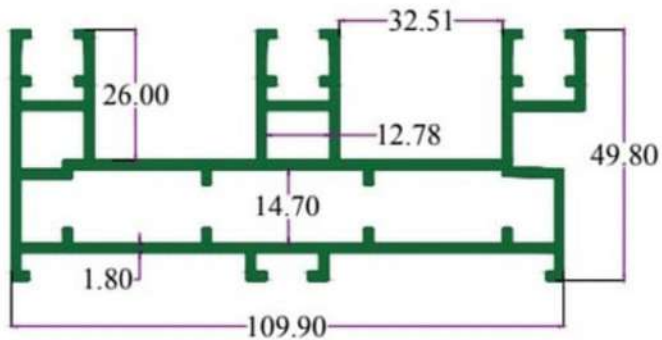

SEC.NO. 4740
WT. 9.020 TO 9.300 KG./ 12'

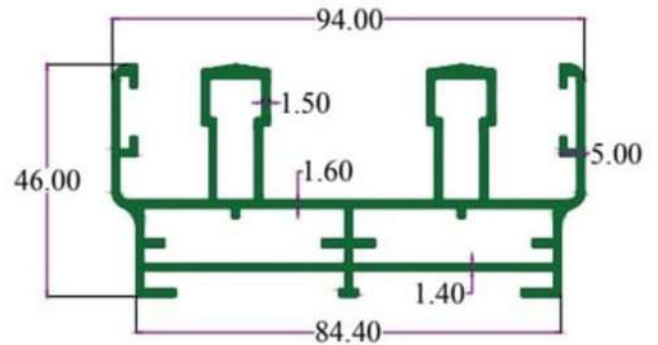

SEC.NO. 4345
WT. 7.100 TO 7.300 KG./ 12'

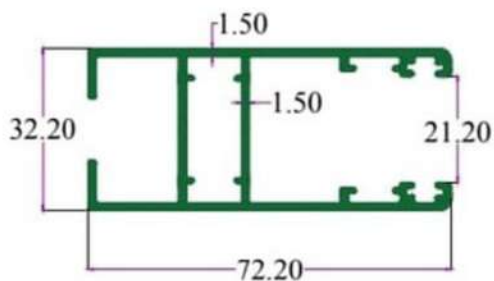

SEC.NO. 4351
WT. 3.760 TO 3.950 KG./ 12'

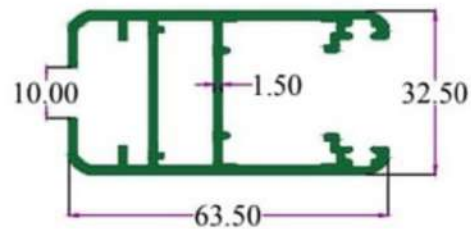

SEC.NO. 3319
WT. 3.850 TO 4.050 KG./12'

DOMAL / CASEMENT



INTELLIGENT
ALUMINIUM
itwalpanel.com

FOLDING SECTIONS

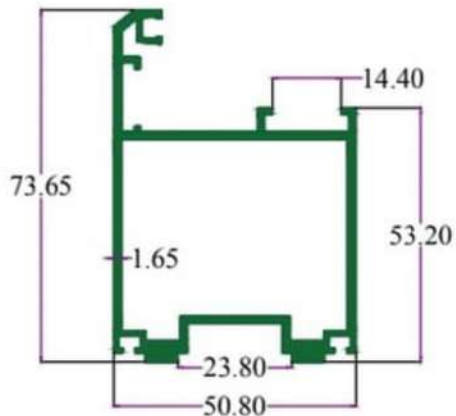

SEC. NO. 5006
WT. 4.735 TO 4.950 KG./ 12'

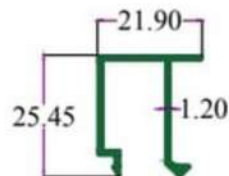

SEC. NO. 5007
WT. 0.940 TO 1.100 KG./ 12'

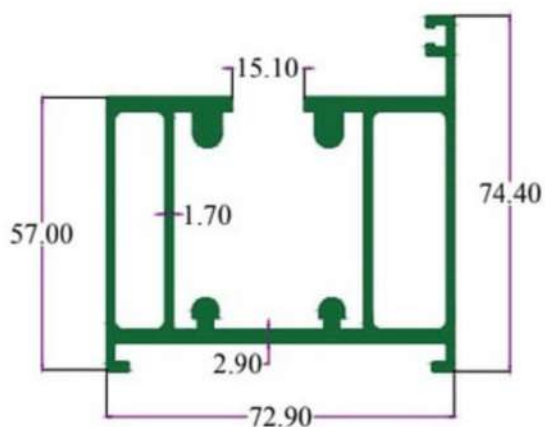

SEC. NO. 5008
WT. 8.860 TO 9.000 KG./ 12'

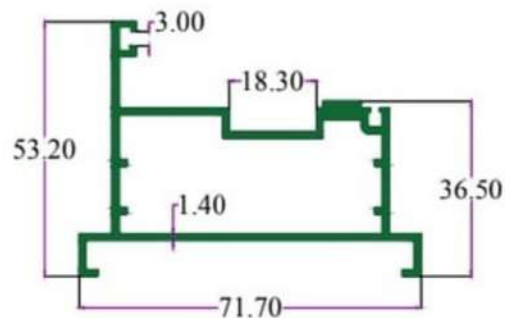

SEC. NO. 5009
WT. 3.625 TO 3.850 KG./ 12'

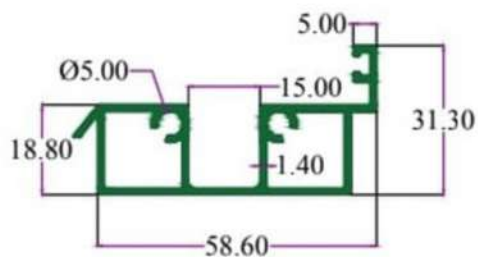

SEC. NO. 5010
WT. 2.900 TO 3.100 KG./ 12'

DOMAL / CASEMENT



INTELLIGENT
ALUMINIUM
itowalpanel.com

CASEMENT SECTIONS

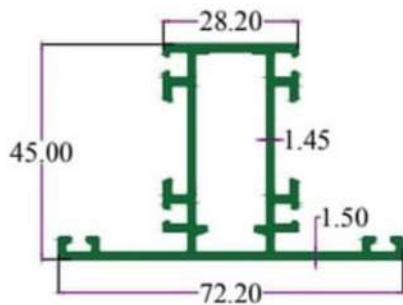

SEC.NO. 4930
WT. 3.720 TO 3.980 KG./ 12'

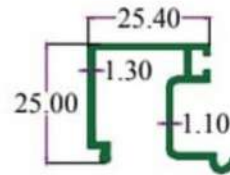

SEC.NO. 4931
WT. 1.200 TO 1.350 KG./ 12'

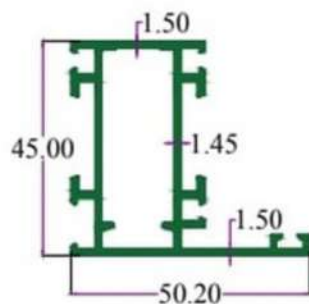

SEC.NO. 4929
WT. 3.225 TO 3.500 KG./ 12'

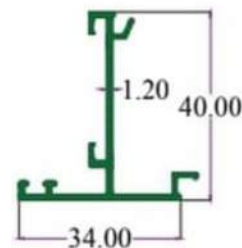

SEC. NO. 4270
WT. 1.200 TO 1.400 KG./ 12'

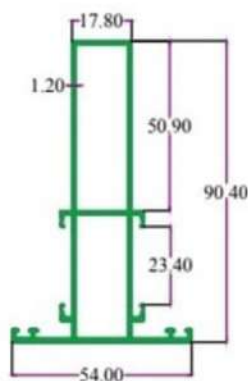

SEC. NO. 4271
WT. 3.500 TO 3.800 KG./ 12'

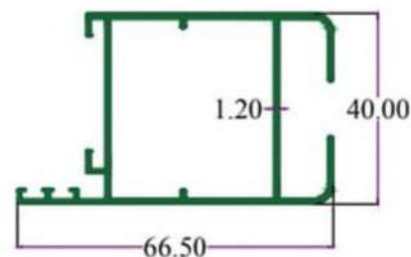

SEC. NO. 3464
WT. 3.500 TO 3.700 KG./ 12'

DOMAL / CASEMENT



INTELLIGENT
ALUMINIUM
itowalpanel.com

MISCELLANEOUS SLIDING WINDOWS

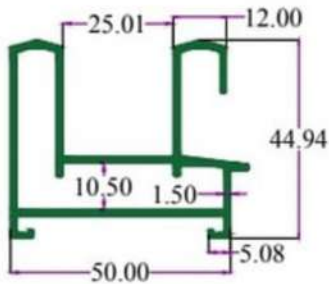

SEC.NO. 4845
WT. 3.650 TO 3.870 KG./ 12'

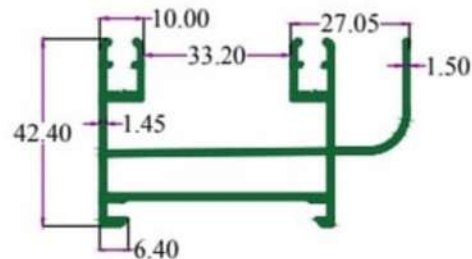

SEC.NO. 4843
WT. 4.180 TO 4.400 KG./ 12'

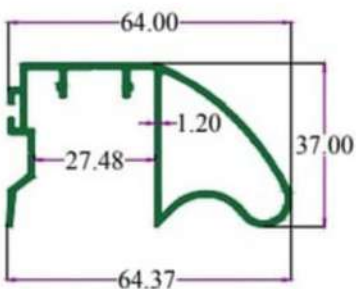

SEC.NO. 4847
WT. 2.580 TO 2.850 KG./ 12'

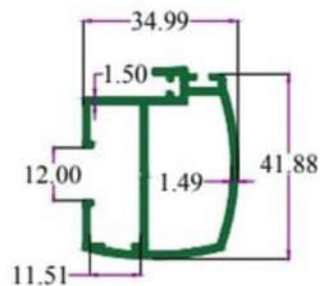

SEC.NO. 4844
WT. 2.630 TO 2.850 KG./ 12'

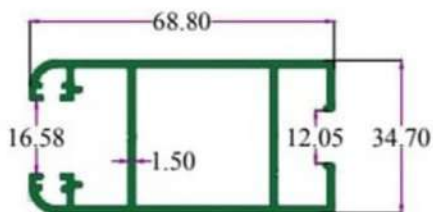

SEC.NO. 4842
WT. 3.760 TO 4.000 KG./ 12'

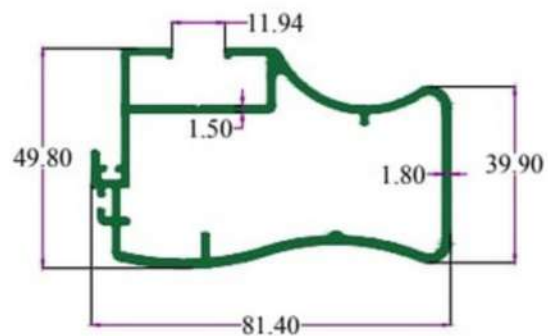

SEC.NO. 4848
WT. 4.880 TO 5.130 KG./ 12'

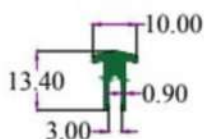

SEC.NO. 4846
WT. 0.470 TO 0.570 KG./ 12'

DOMAL / CASEMENT



INTELLIGENT
ALUMINIUM
itwalpanel.com

35MM CASEMENT SECTIONS

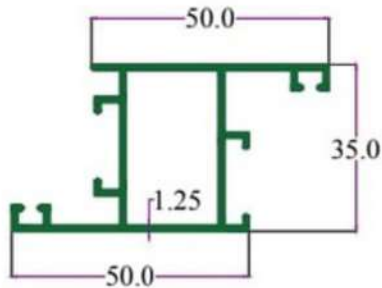

SEC. No. 3284
WT. 2.540 TO 2.800 KG./ 12'

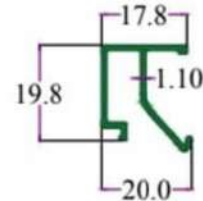

SEC. No. 3285
WT. 0.730 TO 0.850 KG./12'

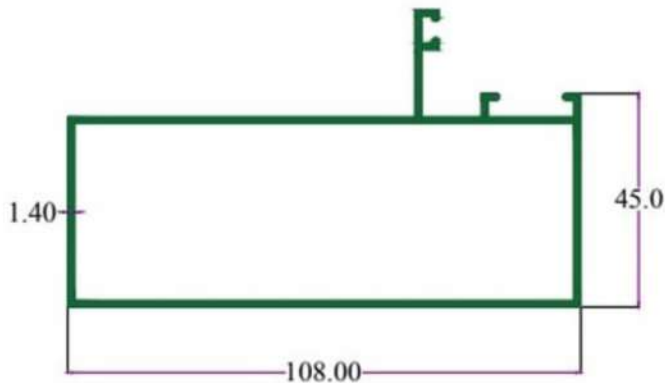

SEC. No. 3286
WT. 4.600 TO 4.900 KG./ 12'

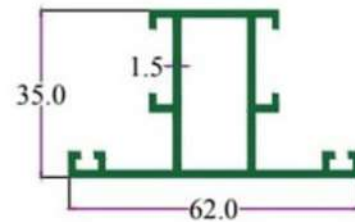

SEC. NO. 3515
WT. 2.300 TO 2.600 KG / 12'

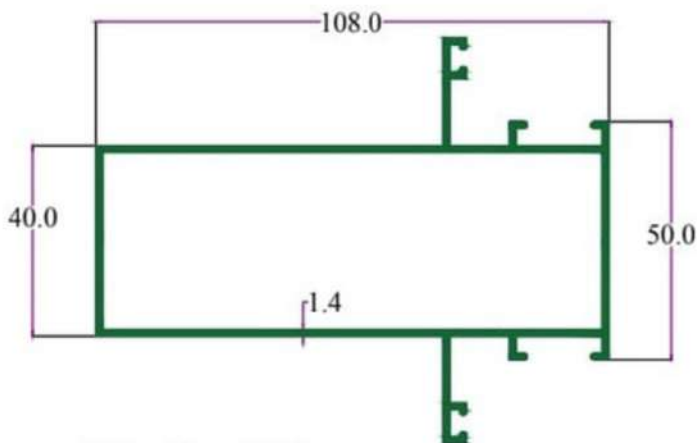

SEC. No. 3287
WT. 5.240 TO 5.500 KG./ 12'

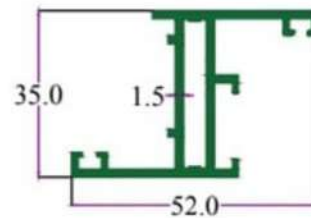

SEC. NO. 3516
WT. 2.200 TO 2.500 KG / 12'

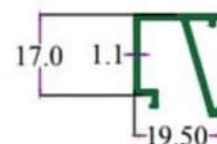

SEC. NO. 3518
WT. 0.700 TO 0.800 KG

DOMAL / CASEMENT



INTELLIGENT
ALUMINIUM
itowalpanel.com

35MM CASEMENT SECTIONS

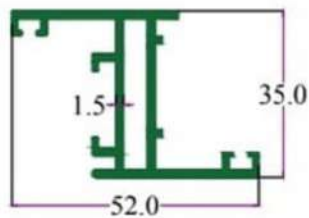

SEC. NO. 3517
WT. 2.300 TO 2.600 KG / 12'

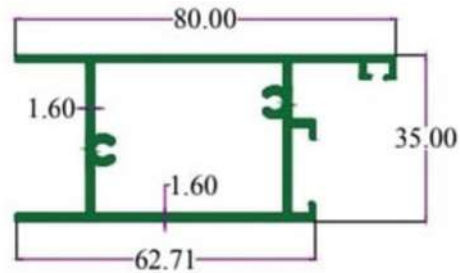

SEC. NO. 3519
WT. 3.600 TO 4.000 KG / 12'

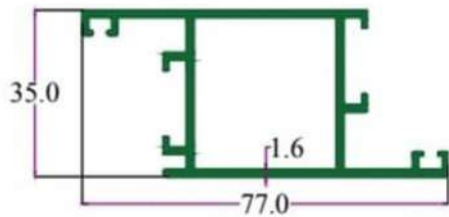

SEC. NO. 3520
WT. 3.100 TO 3.500 KG / 12'

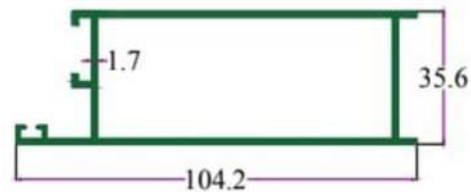

SEC. NO. 2064
WT. 4.647 TO 8.000 KG. / 12'

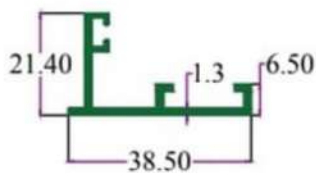

SEC. NO. 2065
WT. 1.000 TO 1.200 KG. / 12'

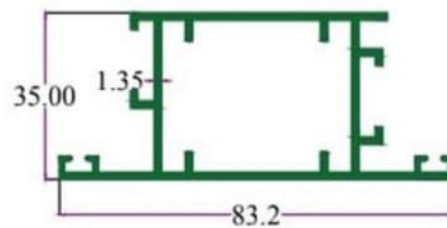

SEC. NO. 2067
WT. 3.622 TO 3.800 KG. / 12'

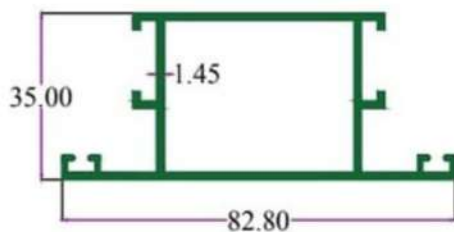

SEC. NO. 2066
WT. 3.400 TO 3.550 KG. / 12'

DOMAL / CASEMENT



INTELLIGENT
ALUMINIUM
itwalpanel.com

FOLDING SECTIONS

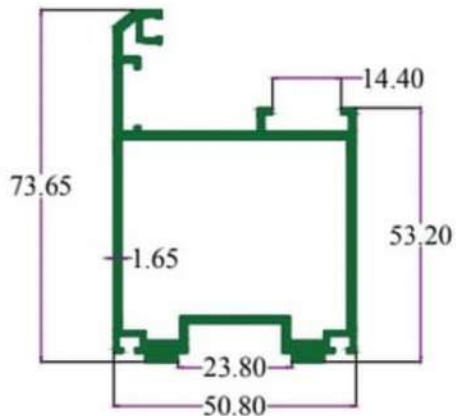

SEC. NO. 5006
WT. 4.735 TO 4.950 KG./ 12'

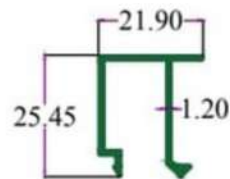

SEC. NO. 5007
WT. 0.940 TO 1.100 KG./ 12'

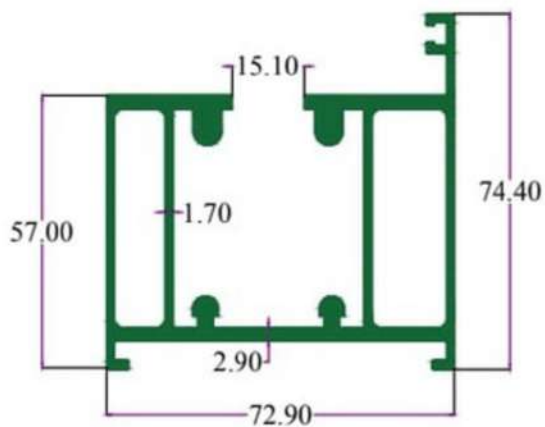

SEC. NO. 5008
WT. 8.860 TO 9.000 KG./ 12'

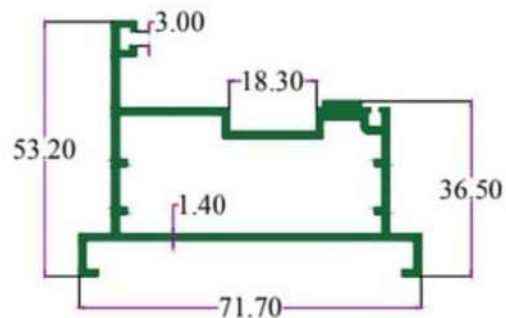

SEC. NO. 5009
WT. 3.625 TO 3.850 KG./ 12'

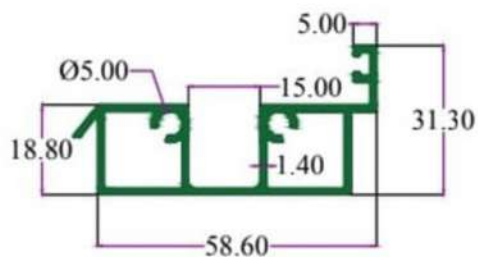

SEC. NO. 5010
WT. 2.900 TO 3.100 KG./ 12'

DOMAL / CASEMENT



INTELLIGENT
ALUMINIUM
itowalpanel.com

38MM CASEMENT SECTIONS

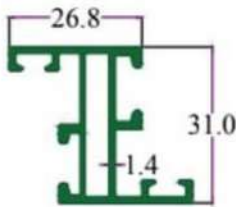

SEC. NO. 2180
WT. 1.900 TO 2.000 KG./ 12'

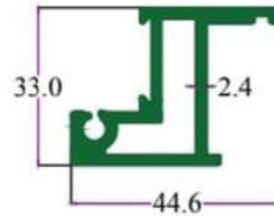

SEC. No. 3154
WT. 3.200 TO 3.540 KG./ 12'

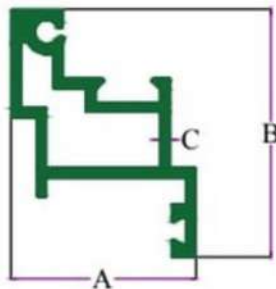

S. No.	Section No.	A IN mm.	B IN mm.	T IN mm.	Weight. (KG./ 12')
1	2183	44.0	45.6	1.20	2.500-3.000
2	2184	44.0	45.6	1.80	2.500-3.000

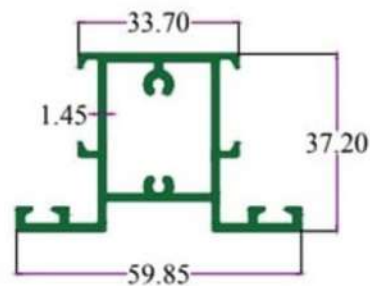

SEC. NO. 3263
WT. 2.906 TO 3.212 KG./ 12'

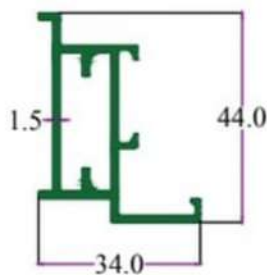

SEC. NO. 3261
WT. 2.026 TO 2.400 KG./ 12'

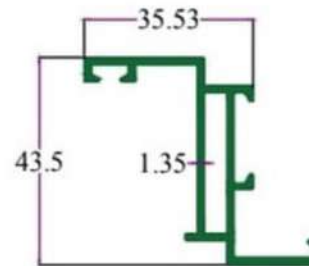

SEC. NO. 3262
WT. 2.070 TO 2.300 KG./ 12'

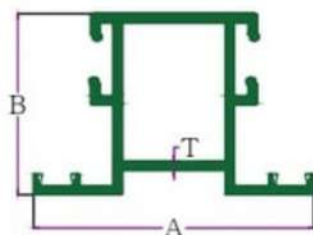

MULLION SECTION

S. No.	Section No.	A IN mm.	B IN mm.	T IN mm.	Weight. (KG./ 12')
1	2101	59.00	38.00	1.40	2.500-2.700
2	2102	59.00	38.00	1.60	2.800-3.100
3	2103	59.00	38.00	1.85	3.200-3.700
4	2104	59.00	38.00	2.00	3.800-4.400

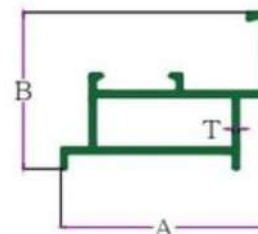

Z LINE SECTION

S. No.	Section No.	A IN mm.	B IN mm.	T IN mm.	Weight. (KG./ 12')
1	2105	43.50	33.00	1.30	1.700-2.000
2	2106	43.50	33.00	1.55	2.100-2.300
3	2107	43.50	33.00	1.80	2.400-2.700
4	2108	43.50	33.00	2.10	3.000-

DOMAL / CASEMENT



INTELLIGENT
ALUMINIUM
itowalpanel.com

38MM CASEMENT SECTIONS

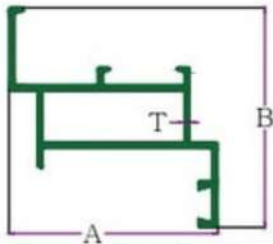

Z HOLLOW SECTION

S. No.	Section No.	A IN mm.	B IN mm.	T IN mm.	Weight (KG./ 12')
1	2109	44.00	46.00	1.20	1.800-2.000
2	2110	44.00	46.00	1.40	2.100-2.300
3	2111	44.00	46.00	1.60	2.400-2.700
4	2112	44.00	46.00	1.80	3.200-3.500
5	2119	44.00	46.00	1.10	1.600-1.800
6	3262	43.50	49.10	1.35	2.070-2.300

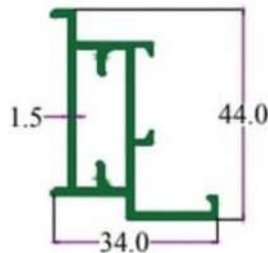

SEC. NO. 3261
WT. 2.026 TO 2.400 KG./ 12'

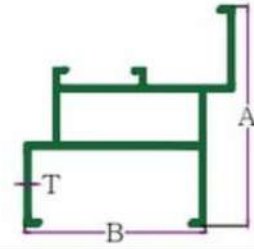

Z BOX SECTION

S. No.	Section No.	A IN mm.	B IN mm.	T IN mm.	Weight (KG./ 12')
1	2113	46.00	38.00	1.20	1.800-2.000
2	2114	46.00	38.00	1.40	2.100-2.300
3	2115	46.00	38.00	1.60	2.400-2.700

Z CLIP SECTION

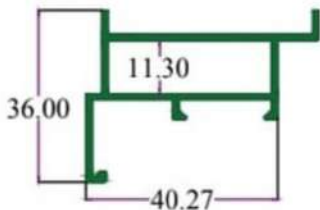

SEC. NO. 2116
WT. 1.800 TO 2.000 KG./ 12'

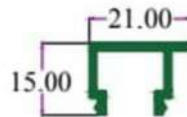

SEC. NO. 2117
WT. 0.400 TO 0.600 KG./ 12'

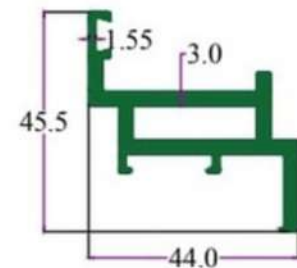

SEC. NO. 2118
WT. 3.900 TO 4.100 KG./ 12'

DOMAL / CASEMENT



INTELLIGENT
ALUMINIUM
itwalpanel.com

40MM CASEMENT SECTIONS

Shutter

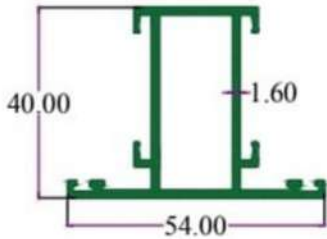

SEC.NO. 3332N / 4766
WT. 2.800 To 3.000 KG/12'

Z-MULLION

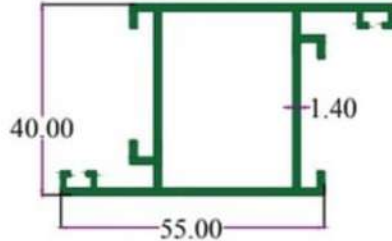

SEC.NO. 3339
WT. 3.050 To 3.250 KG/12'

DOOR FRAME

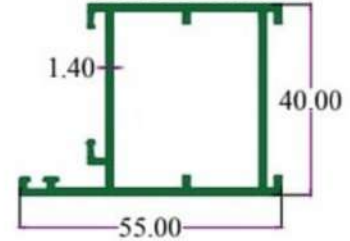

SEC.NO. 3334N
WT. 2.650 To 2.850 KG/12'

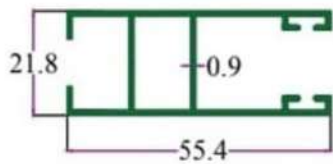

SEC.NO. 3333
WT. 2.800 TO 3.00 KG/ 12'

FRAME

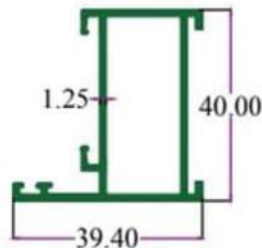

SEC.NO. 3337N
WT. 2.000 To 2.200 KG/12'

CLIP

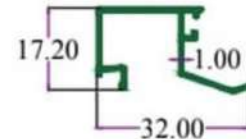

SEC.NO. 3341N
WT. 0.750 To 0.850 KG/12'

MULLION/Shutter

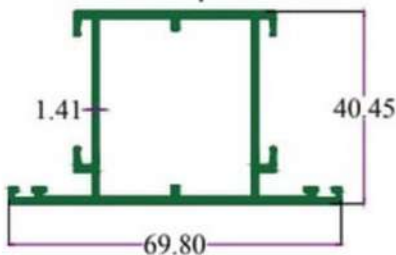

SEC.NO. 3338N
WT. 3.300 To 3.500 KG/12'

Mullion

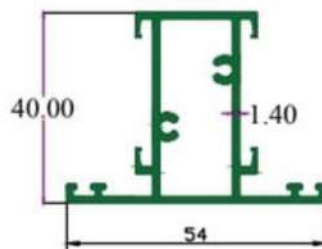

SEC. NO. 3481
WT. 2.600 TO 2.900 KG/12'

FRAME

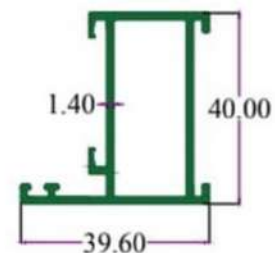

SEC. NO. 3482
WT. 2.100 TO 2.400 KG/12'

Shutter

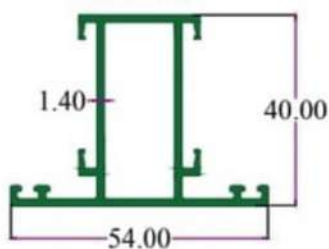

SEC. NO. 3483
WT. 2.350 TO 2.650 KG/12'

MULLION/Shutter

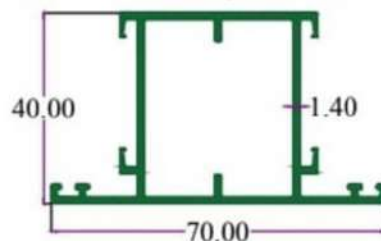

SEC. NO. 3484
WT. 3.950 TO 3.250 KG/12'

Door Bottom

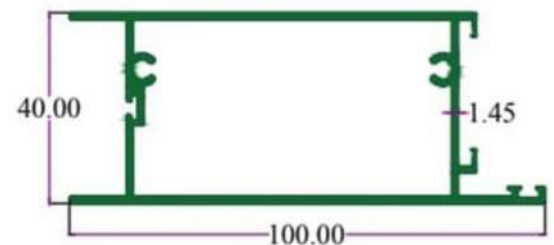

SEC. NO. 3485
WT. 4.100 TO 4.600 KG/12'

DOMAL / CASEMENT



INTELLIGENT
ALUMINIUM
itwalpanel.com

40MM CASEMENT SECTIONS

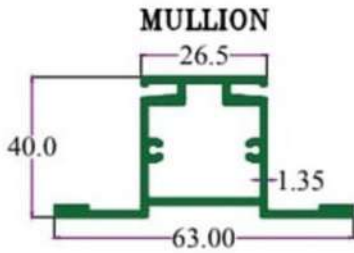

SEC. NO. 2051
WT. 3.900 TO 4.200 KG/15'

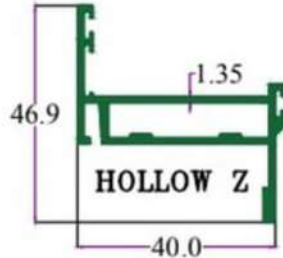

S. No.	Section No.	A IN mm.	B IN mm.	Weight. (KG/ 15')
1	2052 L	46.90	40.00	2.700-2.900
2	2052 M	46.90	40.00	3.400-3.600
3	2052 H	46.90	40.00	4.700-4.900

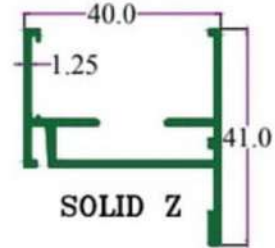

SEC. NO. 2053
WT. 1.700 TO 1.900 KG./ 12'

LAME Z

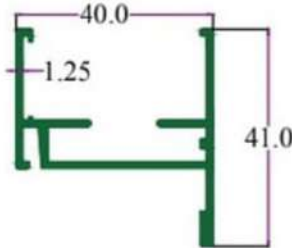

SEC. NO. 2054
WT. 2.900 TO 3.100 KG./ 15'

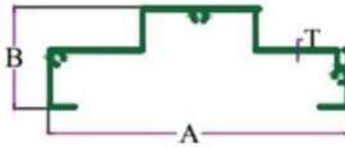

S. No.	Section No.	A IN mm.	B IN mm.	T IN mm.	Weight. (KG/ 12')
1	2056	125.78	39.7	1.50	1.010-1.250
2	2057	125.78	39.7	3.00	2.024-2.300

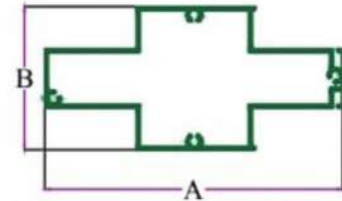

S. No.	Section No.	A IN mm.	B IN mm.	T IN mm.	Weight. (KG/ 12')
1	2058	125.78	58.40	1.50	1.640-1.850
2	2059	125.78	58.40	3.00	3.290-3.450

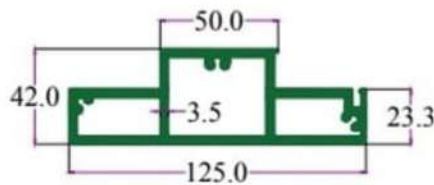

S. No.	Section No.	A IN mm.	B IN mm.	Weight. (KG/ 15')
1	2060	125	42.00	13.00-13.50
2	2069	125	42.00	9.800-10.50
3	3491	125	42.00	11.500-11.800

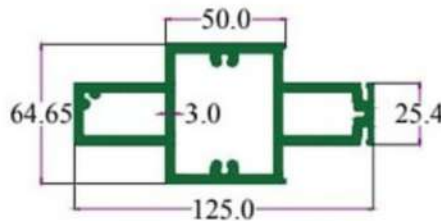

S. No.	Section No.	A IN mm.	B IN mm.	Weight. (KG/ 15')
1	2061	125	64.65	5.000-16.300
2	3492	125	64.65	11.600-11.900

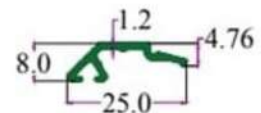

SEC. NO. 3460
WT. 0.450 TO 0.550 KG/12'

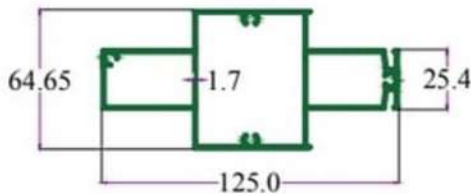

SEC. NO. 2062
WT. 7.800 TO 8.000 KG/12'

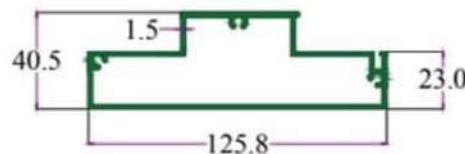

SEC. NO. 2063
WT. 5.260 TO 5.450 KG/12'

DOMAL / CASEMENT



INTELLIGENT
ALUMINIUM
itowalpanel.com

42MM CASEMENT SECTIONS

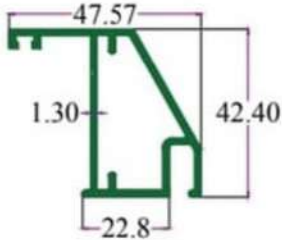

SEC. NO. 2181
WT. 1.900 TO 2.200 KG/12'

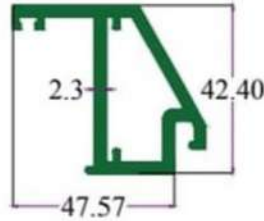

SEC. NO. 2182
WT. 3.950 TO 4.100 KG/15'

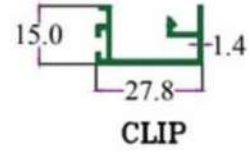

SEC. NO. 2164
WT. 1.050 TO 1.240 K./15'

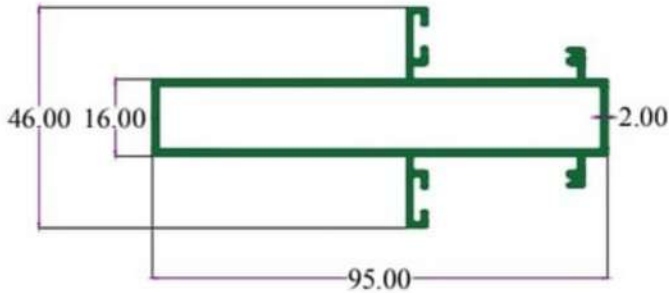

SEC. NO. 2201
WT. 3.900 TO 4.400 KG/15'

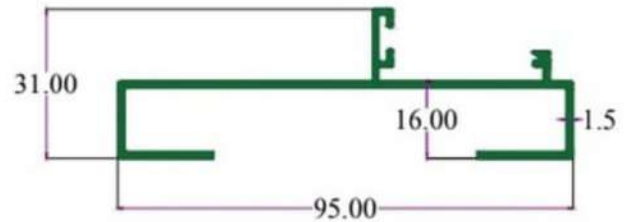

SEC. NO. 2202
WT. 2.600 TO 3.100 KG/15'

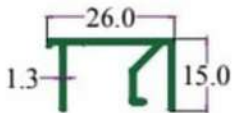

SEC. NO. 2203
WT. 1.050 TO 1.400 KG/15'

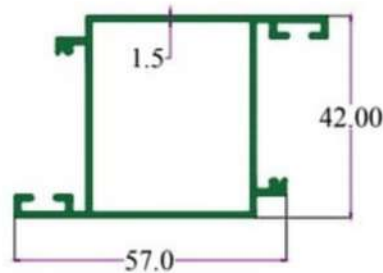

SEC. NO. 2204
WT. 2.600 TO 3.100 KG/15'

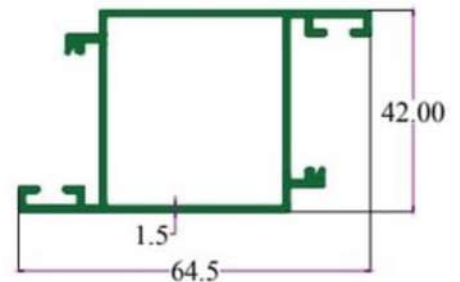

SEC. NO. 2205
WT. 3.250 TO 3.750 KG/15'

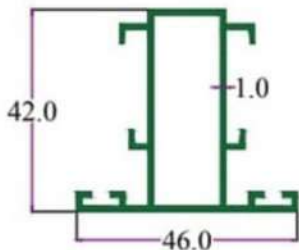

MULLION

SEC. NO. 2161
WT. 2.200 TO 2.700 KG/15'

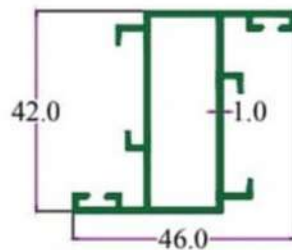

HOLLOW-Z

SEC. NO. 2162
WT. 2.300 TO 2.800 KG/15'

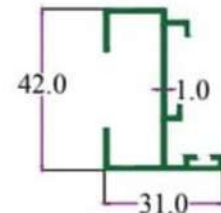

LAME-Z

SEC. NO. 2163
WT. 2.200 TO 2.500 KG/15'

DOMAL / CASEMENT



INTELLIGENT
ALUMINIUM
itowalpanel.com

50MM CASEMENT SECTIONS

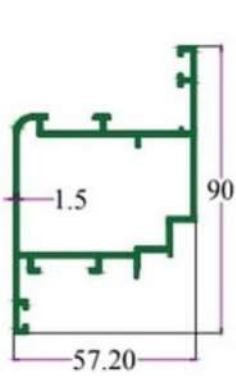

SEC. NO. 3940
WT. 4.400 TO 4.80 KG/12'

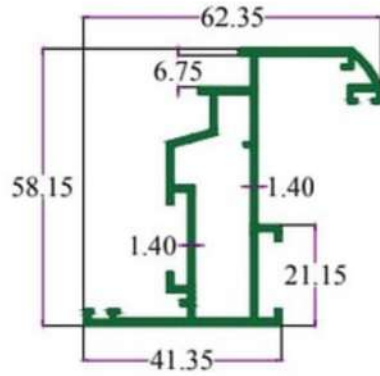

SEC. NO. 4768
WT. 3.320 TO 3.520 KG/12'

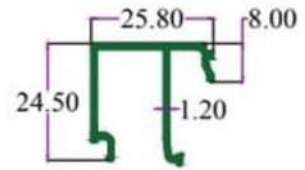

SEC. NO. 4770
WT. 1.020 TO 1.150 KG/12'

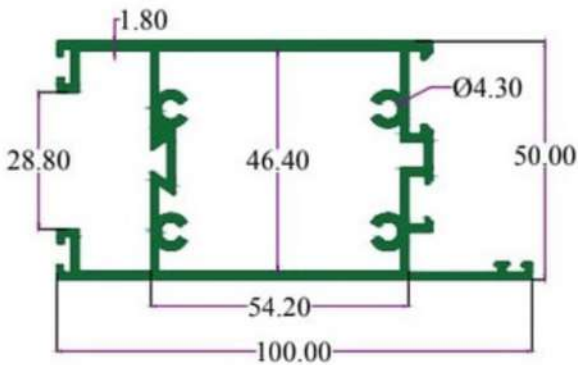

SEC. NO. 4769
WT. 6.550 TO 6.800 KG/12'

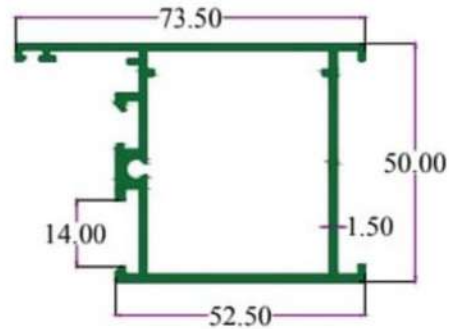

SEC. NO. 4771
WT. 3.320 TO 3.520 KG/12'

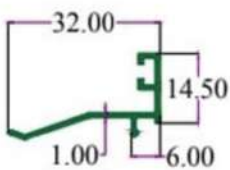

SEC. NO. 4773
WT. 0.600 TO 0.700 KG/12'

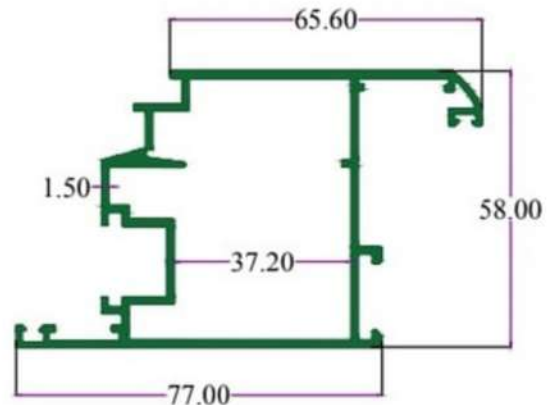

SEC. NO. 4774
WT. 5.150 TO 5.400 KG/12'

DOMAL / CASEMENT



INTELLIGENT
ALUMINIUM
itowalpanel.com

50MM CASEMENT SECTIONS

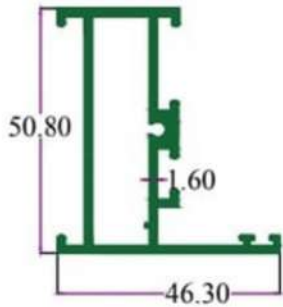

SEC. NO. 3778
WT. 3.600 TO 3.800 KG/12'

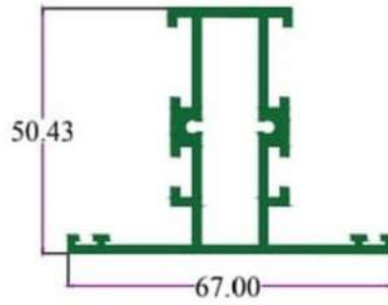

SEC. NO. 3779
WT. 4.50 TO 4.80 KG/12'

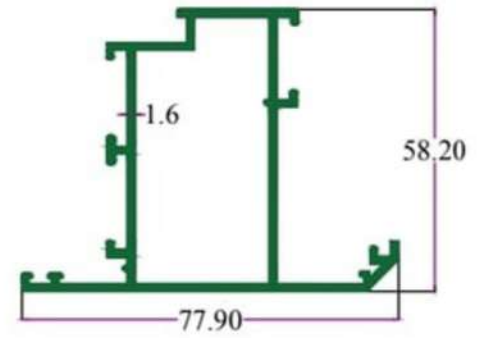

SEC. NO. 3780
WT. 4.200 TO 4.500 KG/12'

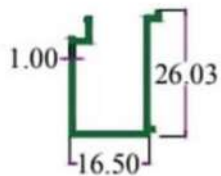

SEC. NO. 3781
WT. 0.70 TO 0.90 KG/12'

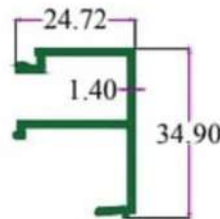

SEC. NO. 3782
WT. 1.20 TO 1.50 KG/12'

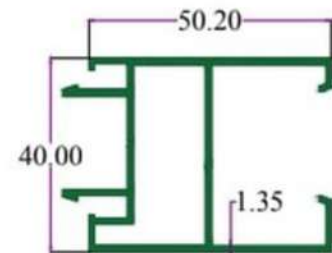

SEC. NO. 3783
WT. 2.850 TO 3.00 KG/12'

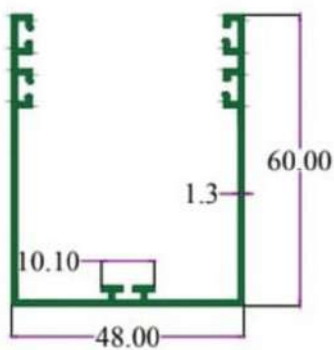

SEC. NO. 3784
WT. 2.600 TO 2.900 KG/12'

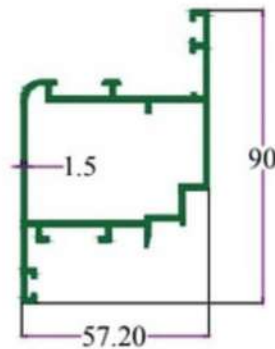

SEC. NO. 3940
WT. 4.400 TO 4.80 KG/12'

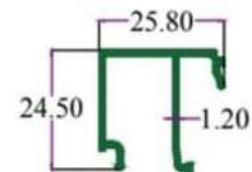

SEC. NO. 4770
WT. 1.030 TO 1.130 KG/12'

DOMAL / CASEMENT



INTELLIGENT
ALUMINIUM
itwalpanel.com

50MM CASEMENT SECTIONS

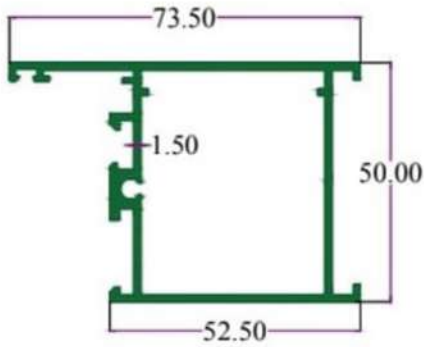

SEC.NO. 4771
WT. 3.320 TO 3.520 KG/12'

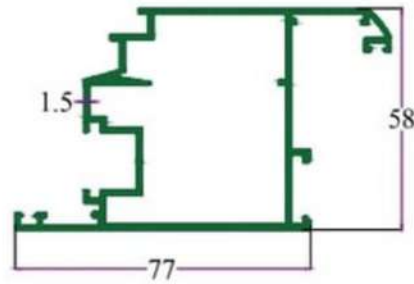

SEC.NO. 4774
WT. 5.150 TO 5.400 KG/12'

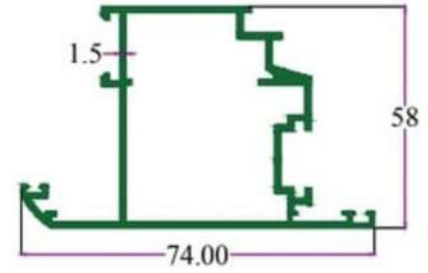

SEC.NO. 4775
WT. 3.320 TO 3.520 KG/12'

WINDOW MESH



INTELLIGENT
ALUMINIUM
itowalpanel.com

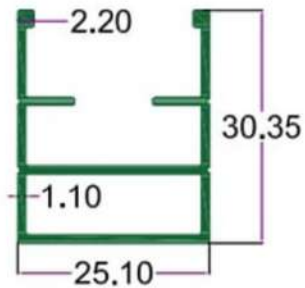

SEC.NO. 4776
WT. 1.290 TO 1.400 KG./ 12'

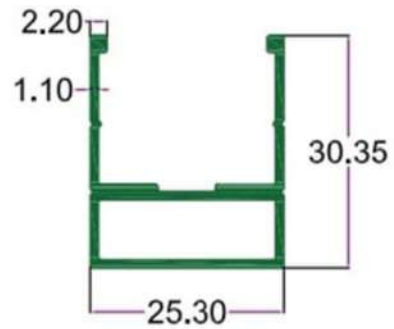

SEC.NO. 4777
WT. 1.340 TO 1.450 KG./ 12'

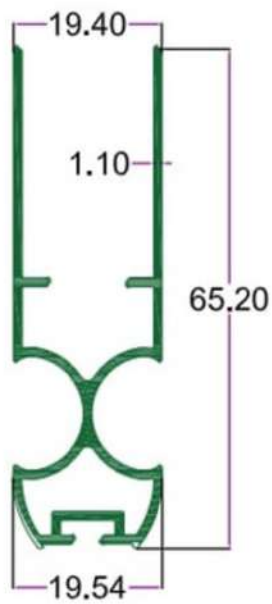

SEC.NO. 4778
WT. 2.000 TO 2.150 KG./ 12'

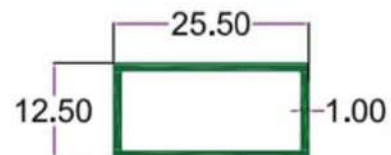

SEC.NO. 4779
WT. 0.700 TO 0.800 KG./ 12'

WINDOW MESH



INTELLIGENT
ALUMINIUM
itw@alpanel.com

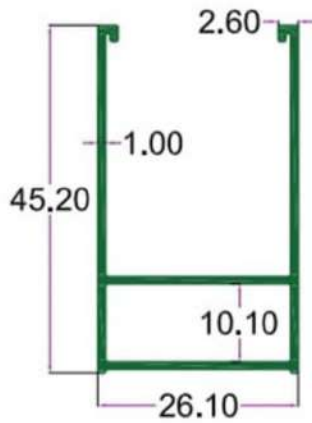

SEC.NO. 4431
WT. 1.400 TO 1.600 KG/12'

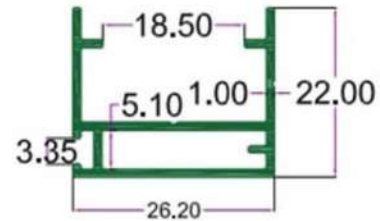

SEC.NO. 4433
WT. 1.000 TO 1.200 KG/12'

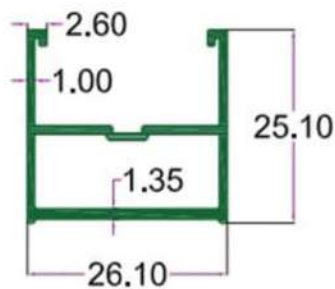

SEC.NO. 4432
WT. 1.100 TO 1.300 KG/12'

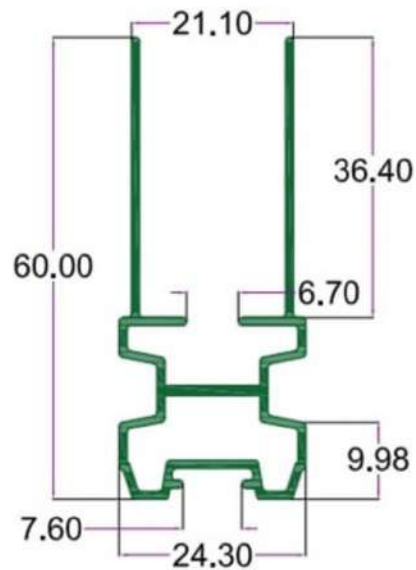

SEC.NO. 4434
WT. 1.930 TO 2.1500 KG/12'



INTELLIGENT
ALUMINIUM

2024



CONTACT US

 +91 9205080482

 hello@itswallpanel.com

 www.itswallpanel.com

 Ghaziabad , India