

# CURTAIN WALL

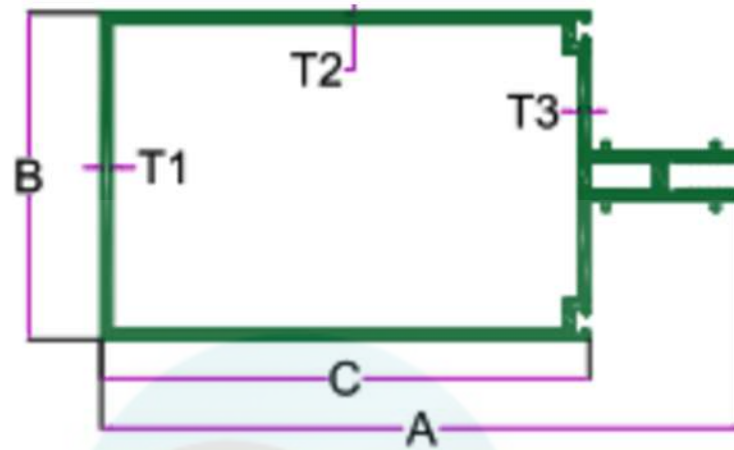

INTELLIGENT  
ALUMINIUM

itswallpanel.com



Sr.No.	Section No.	A IN mm.	B IN mm.	C IN mm.	T1 IN mm.	T2 IN mm.	T3 IN mm.	Weight (KG/12')
1	2444	81.00	67.00	50.00	2.00	2.00	2.13	6.320-6.500
2	5079	81.00	67.00	50.00	2.50	2.50	2.13	7.120-7.350
3	5080	81.00	67.00	50.00	3.00	3.00	2.13	8.680-8.860
4	2442	131.00	67.00	100.00	2.00	2.00	2.25	8.750-8.950
5	5081	131.00	67.00	100.00	2.50	2.50	2.25	9.760-9.950
6	5082	131.00	67.00	100.00	3.00	3.00	2.25	11.840-12.050
7	4144	131.00	67.00	100.00	2.20	2.20	2.20	8.050-8.150
8	3834	151.00	67.00	119.80	2.00	2.00	2.00	9.000-9.200
9	3834	151.00	67.00	119.80	3.00	3.00	3.00	15.740-16.050
10	3834	151.00	67.00	119.80	4.00	4.00	4.00	15.740-16.050
11	5053	163.00	67.00	131.84	2.00	2.00	2.25	14.250-14.500
12	3835	167.00	67.00	135.84	2.00	2.00	2.00	9.870-10.000
13	3835	167.00	67.00	135.84	2.50	2.50	2.50	13.790-14.050
14	3835	167.00	67.00	135.84	3.00	3.00	3.00	13.790-14.050
15	3835	167.00	67.00	135.84	5.00	3.00	3.00	14.650-14.850
16	4947	167.00	67.00	135.84	3.00	3.00	2.25	13.540-13.700
17	4950	167.00	67.00	135.84	5.00	3.00	2.25	14.490-14.990
18	4139	174.50	67.00	143.40	4.50	2.70	2.55	13.280-13.630
19	5070	191.00	67.00	160.00	5.00	3.00	2.50	15.950-16.200

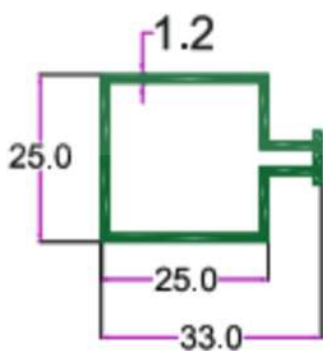

SEC. NO. 2511  
WT. 1.330 TO 1.500 KG/12'

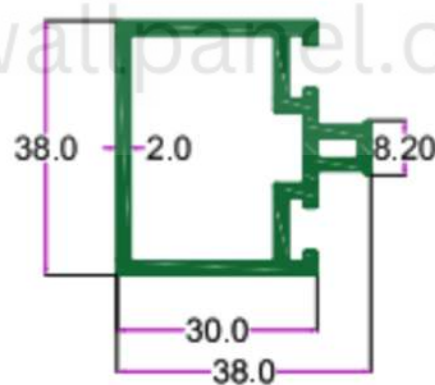

SEC. NO. 2505  
WT. 3.080 TO 3.250 KG/12'

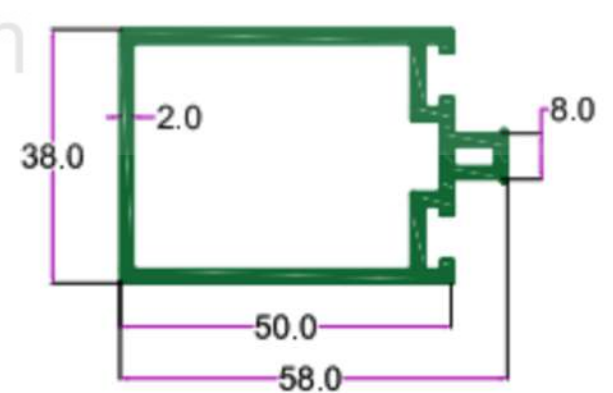

SEC. NO. 2509  
WT. 3.000 TO 3.200 KG/12'

# CURTAIN WALL



INTELLIGENT  
ALUMINIUM

itswallpanel.com

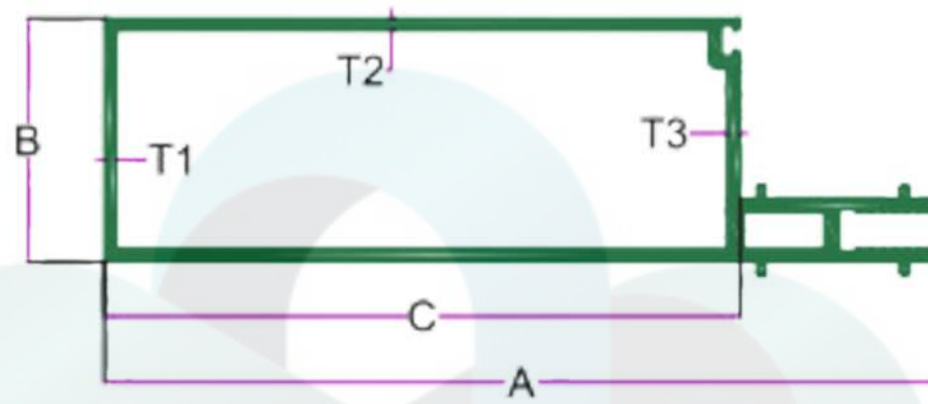

Sr.No.	Section No.	A IN mm.	B IN mm.	C IN mm.	T1 IN mm.	T2 IN mm.	T3 IN mm.	Weight (KG/12')
1	2445	81.16	38.50	50.00	1.80	1.80	1.80	4.480-4.690
2	2445	81.16	38.50	50.00	1.80	1.80	1.80	4.480-4.690
3	2443	131.00	38.50	100.00	2.00	2.00	2.00	6.700-6.850
4	2443/1	131.00	38.50	100.00	5.00	5.00	5.00	15.530-15.850
5	3832	151.00	38.50	119.84	2.80	2.80	2.80	9.390-9.560
6	3832	151.00	38.50	119.84	5.00	5.00	5.00	9.390-9.560
7	3833	167.00	38.50	135.84	2.00	2.00	2.00	8.330-8.500
8	3833/1	167.00	38.50	135.84	3.00	3.00	3.00	11.280-11.460
9	5069	191.00	38.50	160.00	3.00	3.00	3.00	13.000-13.250

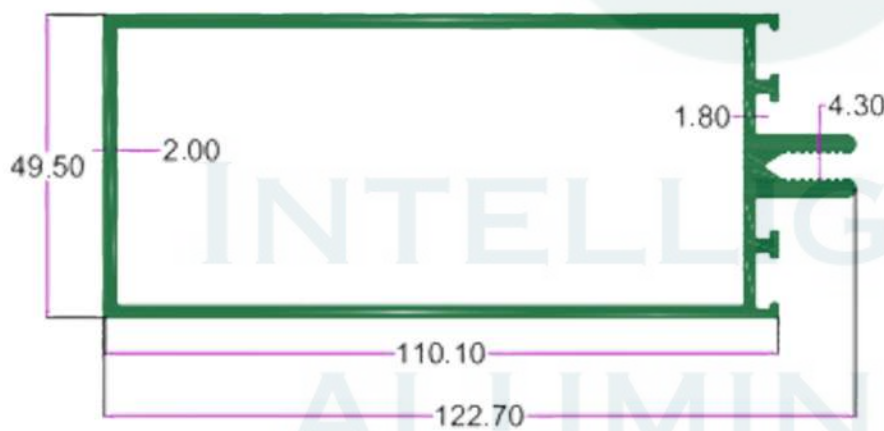

SEC. NO. 4161  
WT. 7.150 TO 7.650 KG/12'

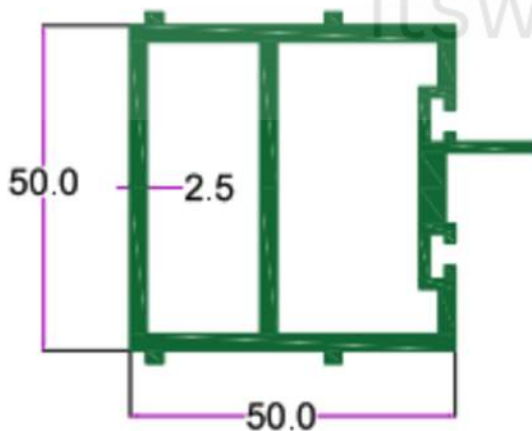

SEC. NO. 2510  
WT. 6.260 TO 6.400 KG/12'

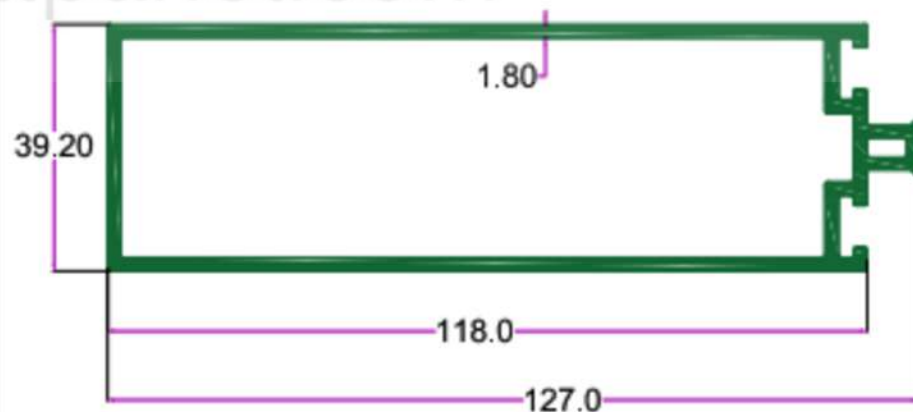

SEC. NO. 2508  
WT. 6.530 TO 6.750 KG/12'

# CURTAIN WALL



INTELLIGENT  
ALUMINIUM

itswallpanel.com

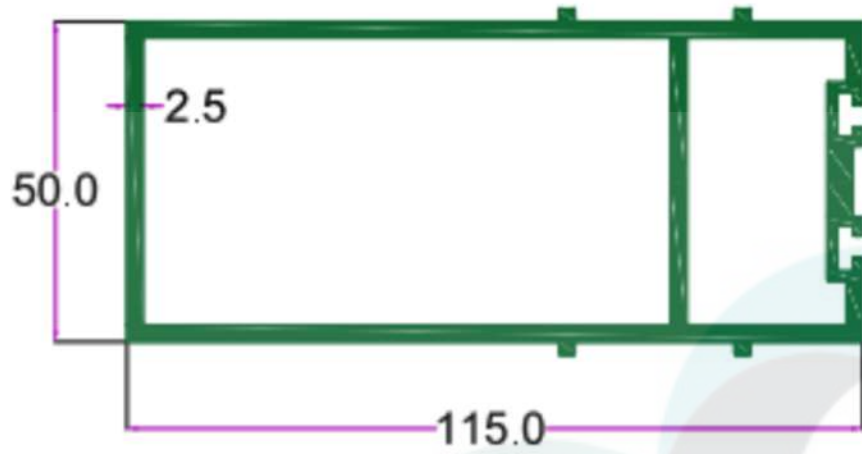

SEC. NO. 2512  
WT. 9.370 TO 9.560 KG./12'

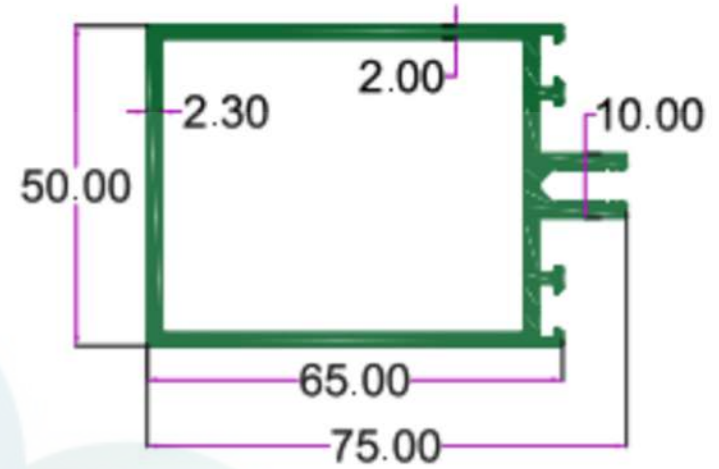

SEC.NO. 4864  
WT. 5.500 TO 5.750 KG./ 12'

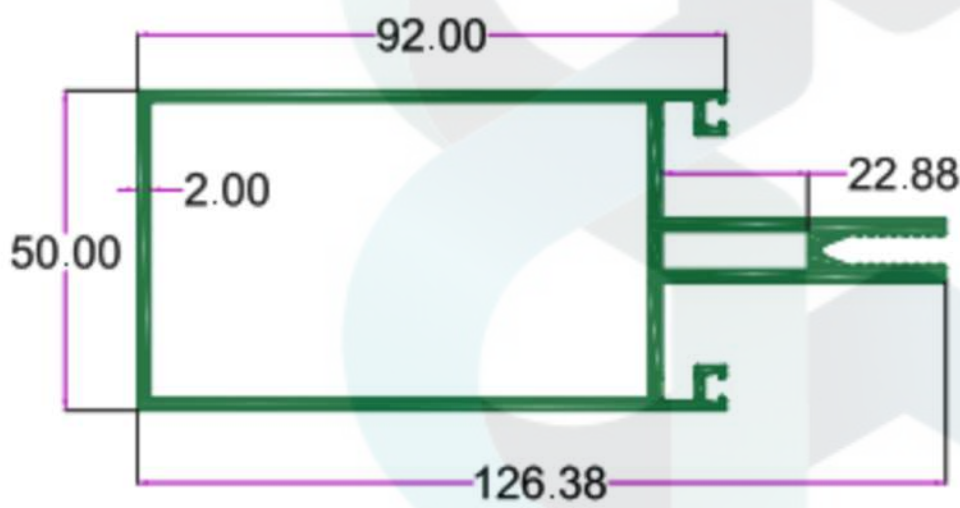

SEC. NO. 2461  
WT.7.450 To 7.750 KG./15'

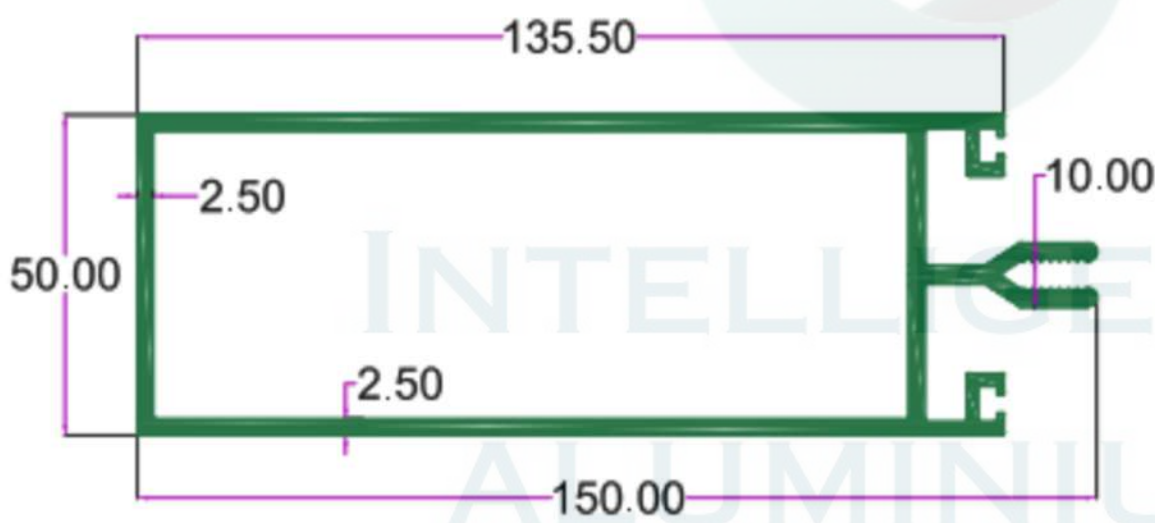

SEC. NO. 4160  
WT. 10.400 TO 10.900 KG/12'

itswallpanel.com

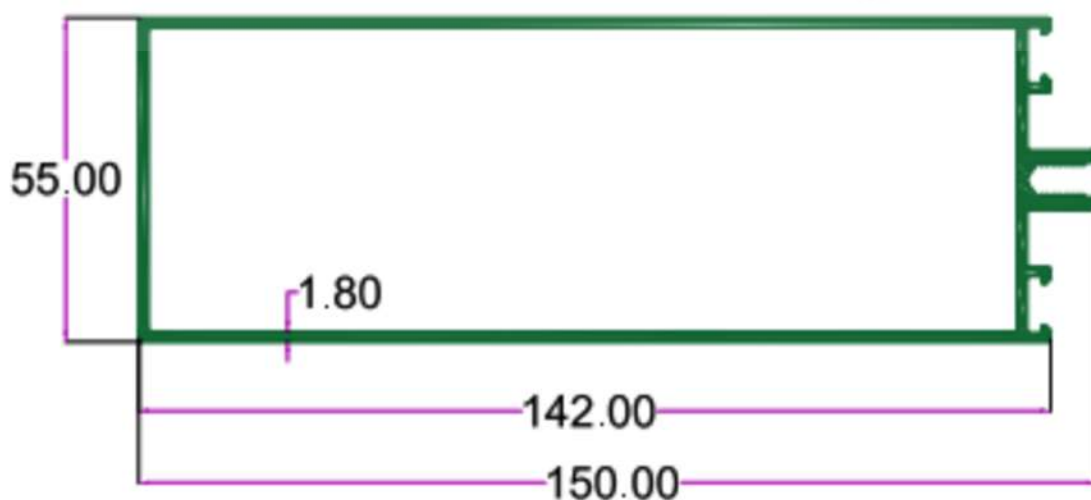

SEC. NO. 3831  
WT. 7.500 TO 7.800 KG./12'

# CURTAIN WALL



INTELLIGENT  
ALUMINIUM

itswallpanel.com

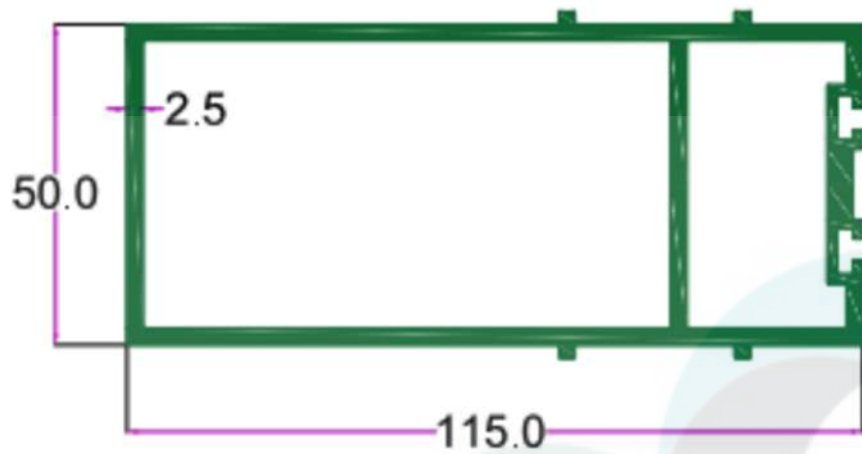

SEC. NO. 2512  
WT. 9.370 TO 9.560 KG./12'

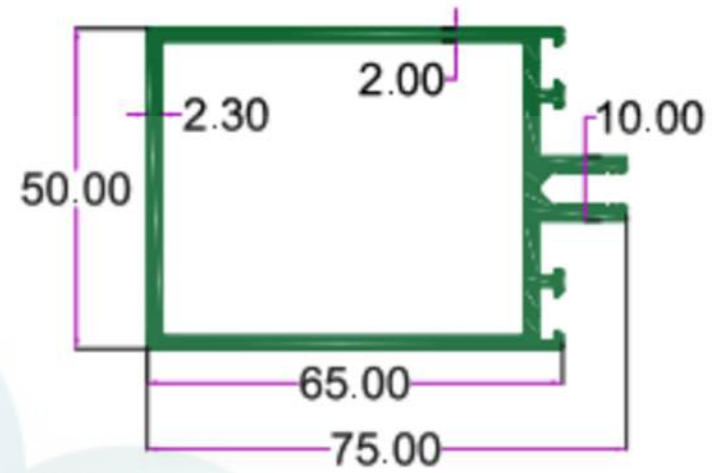

SEC.NO. 4864  
WT. 5.500 TO 5.750 KG./ 12'

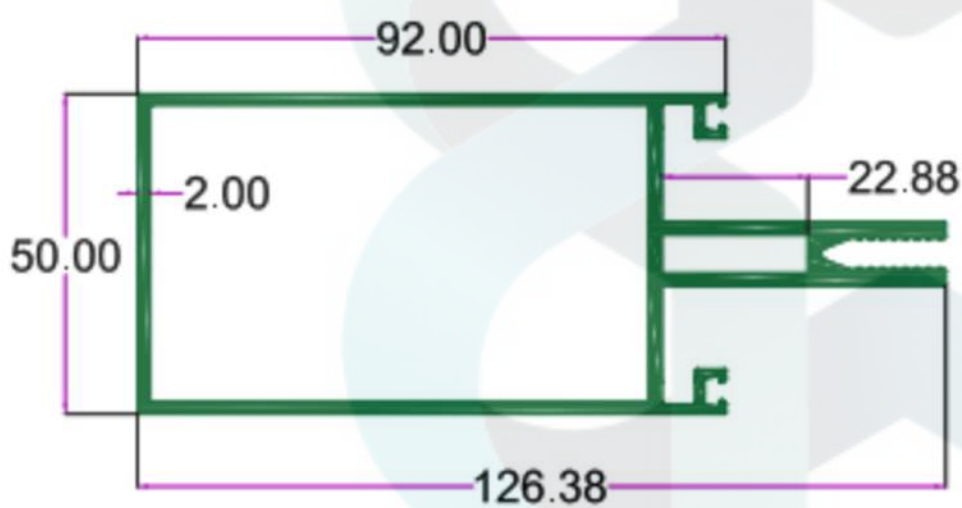

SEC. NO. 2461  
WT.7.450 To 7.750 KG./15'

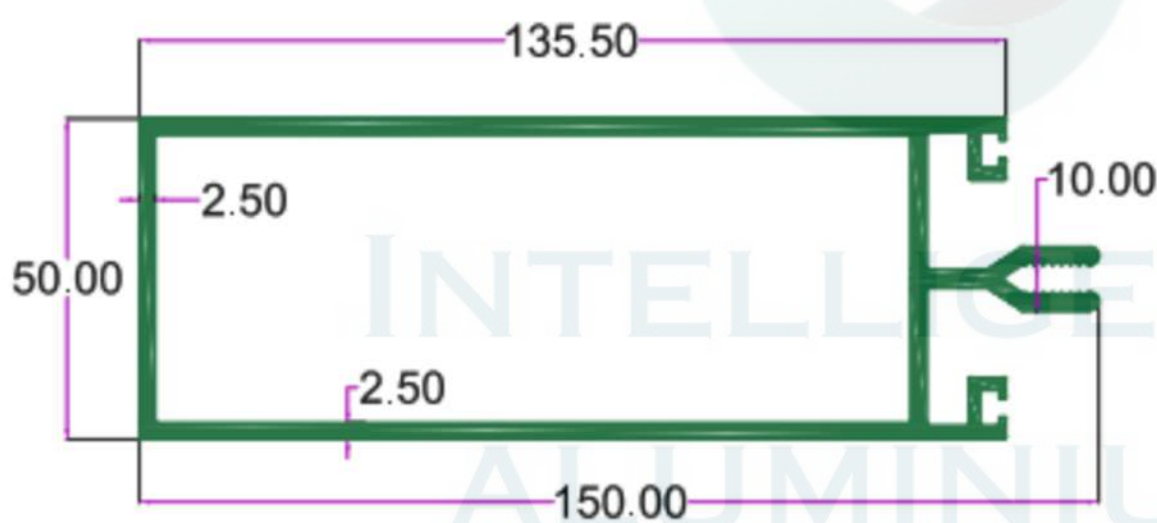

SEC. NO. 4160  
WT. 10.400 TO 10.900 KG/12'

itswallpanel.com

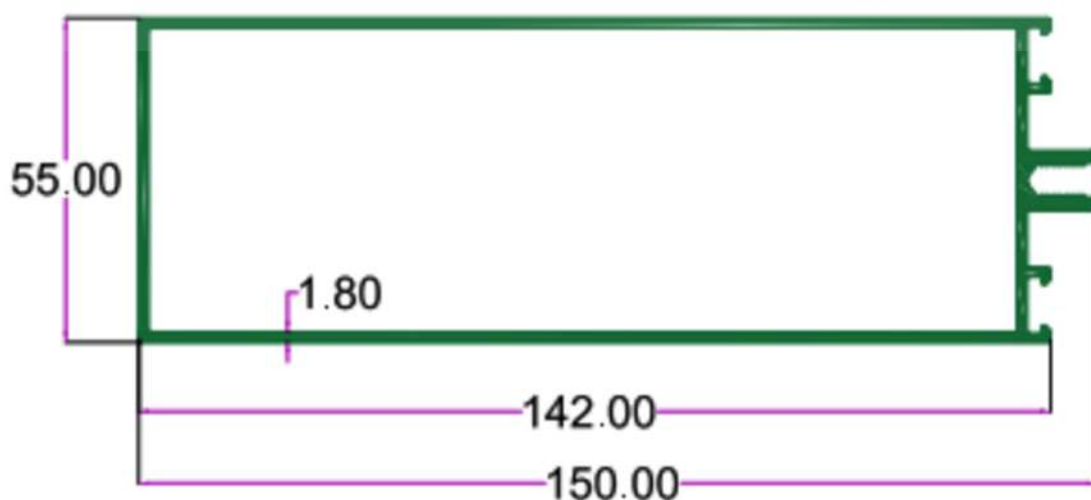

SEC. NO. 3831  
WT. 7.500 TO 7.800 KG./12'

# CURTAIN WALL



INTELLIGENT  
ALUMINIUM

itswallpanel.com

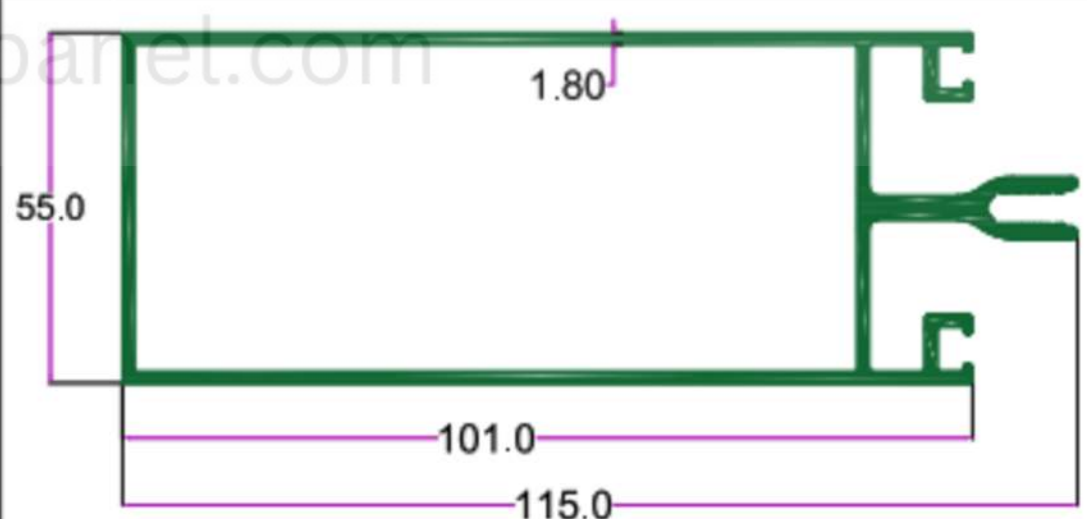
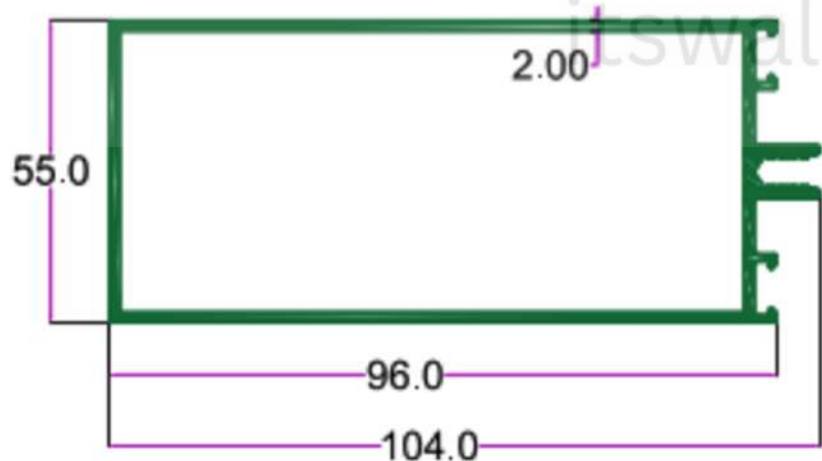
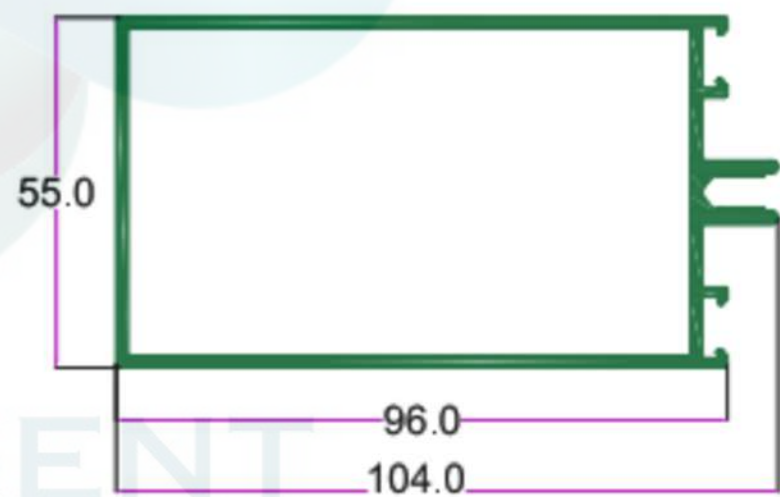
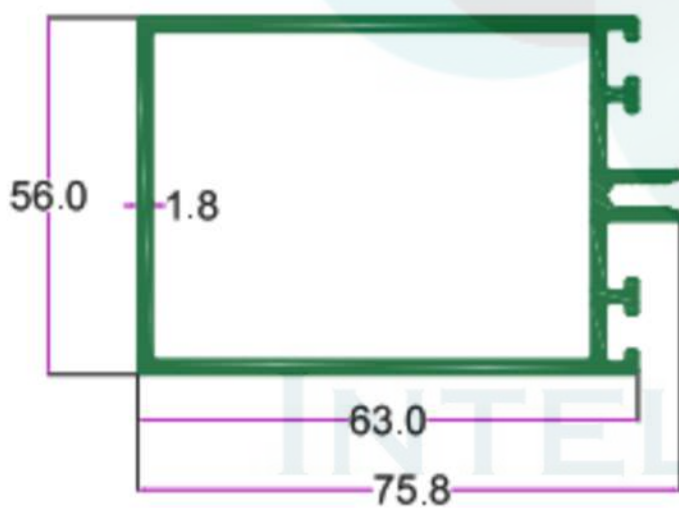
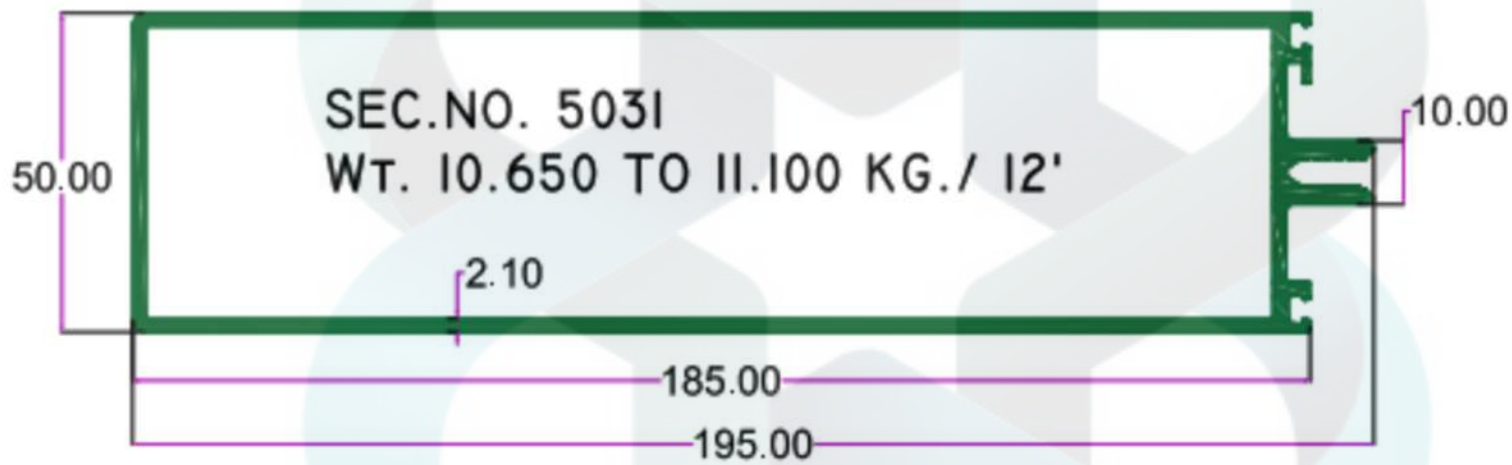
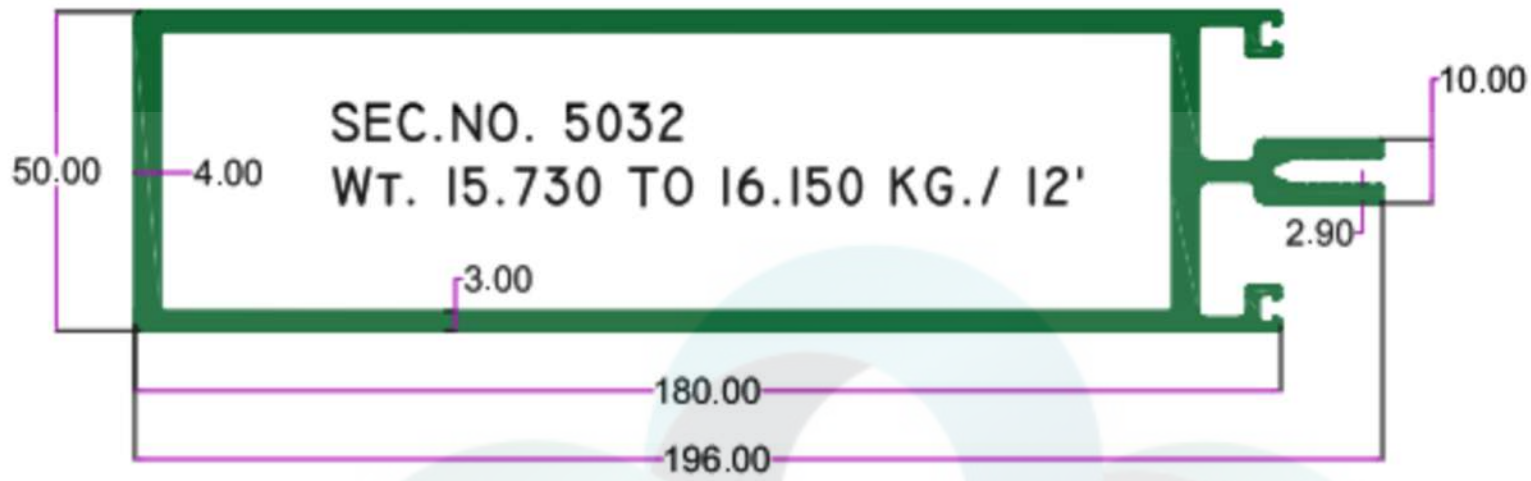

# CURTAIN WALL



INTELLIGENT  
ALUMINIUM

itswallpanel.com

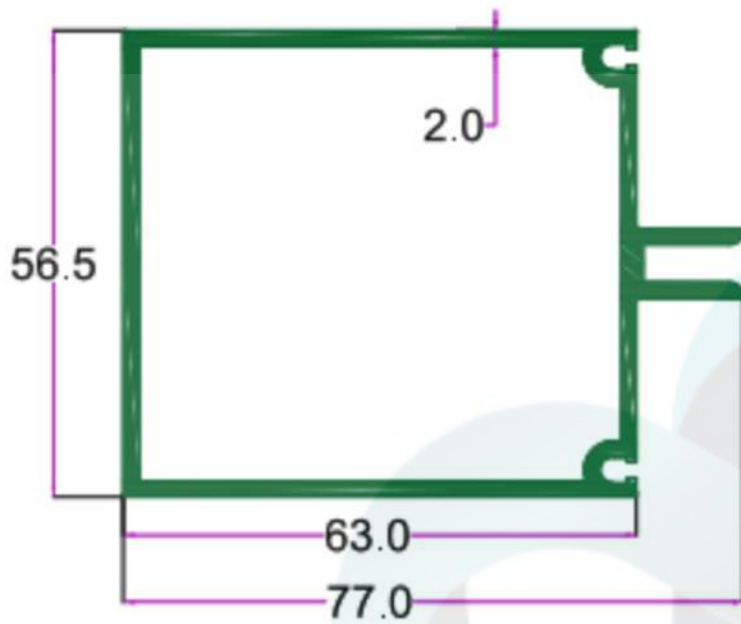

SEC. NO. 2436  
WT. 7.000 TO 7.500 KG./15'



SEC. NO. 2437  
WT. 10.850 TO 11.220 KG./15'

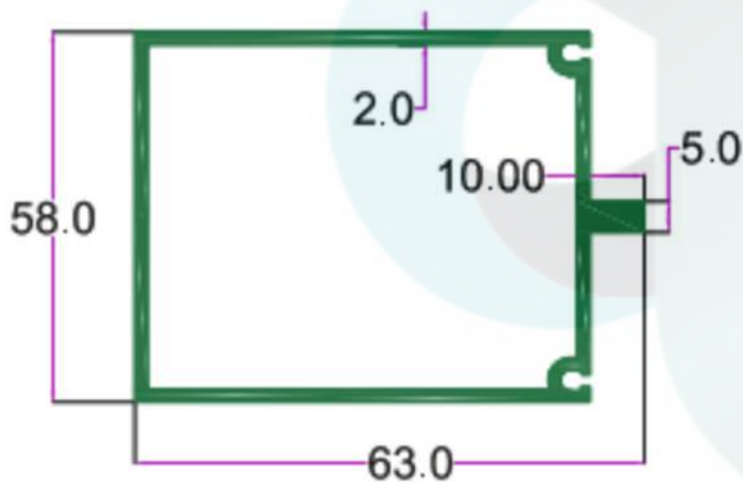

SEC. NO. 2434  
WT. 6.500 TO 7.200 KG./15'

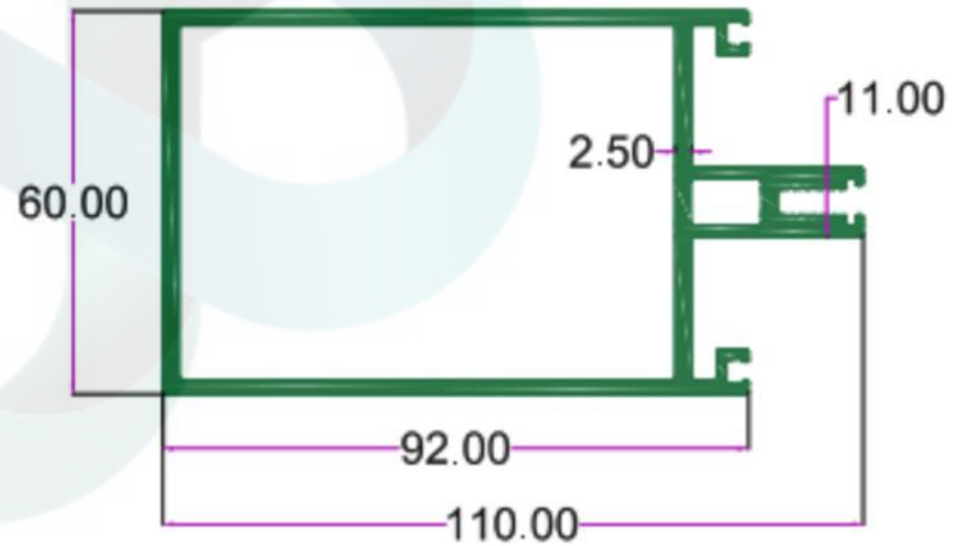

SEC. NO. 4372  
WT. 9.270 TO 9.750 KG./12'

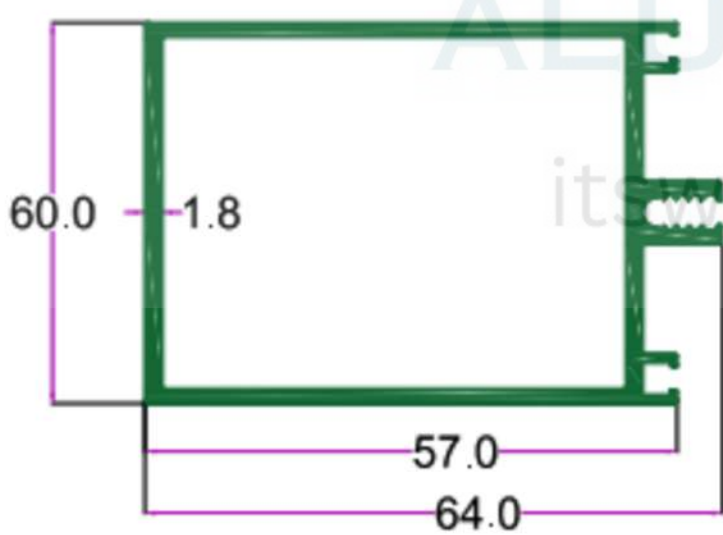

SEC. NO. 2435  
WT. 6.800 TO 7.300 KG./15'

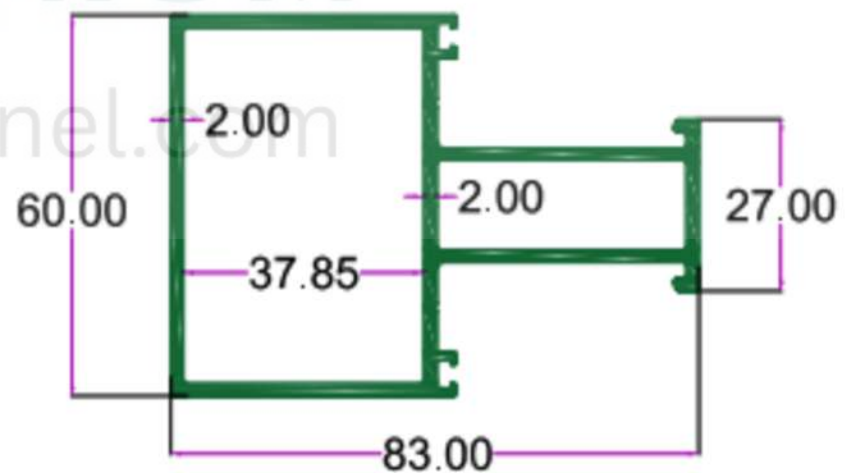

SEC. NO. 4859  
WT. 6.200 TO 6.450 KG./12'

# CURTAIN WALL



INTELLIGENT  
ALUMINIUM

itswallpanel.com

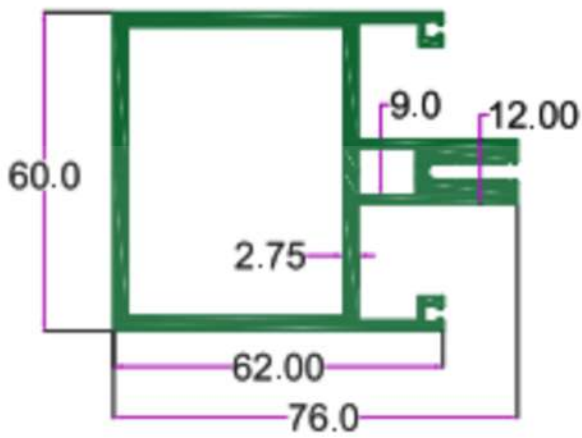

SEC. No. 2439  
WT. 8.000 TO 8.500 KG/I2'

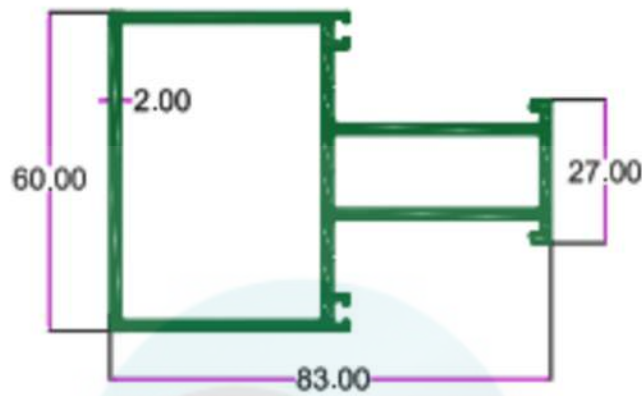

SEC.NO. 4859  
WT. 6.200 TO 6.450 KG/I2'

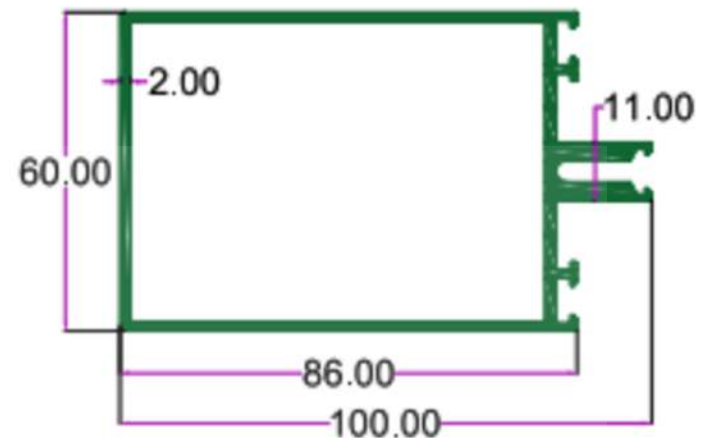

SEC.NO. 4359  
WT. 6.500 TO 6.750 KG/I2'

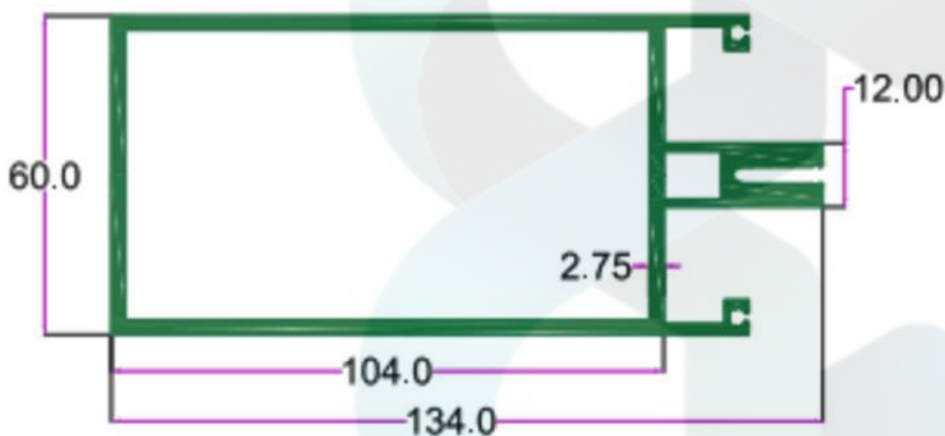

SEC. No. 2438  
WT. 12.390 TO 12.600 KG/I2'

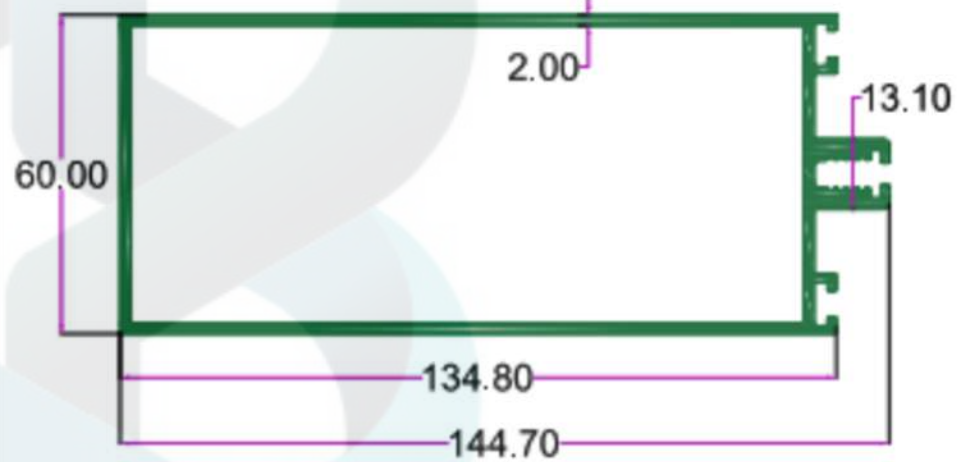

SEC.NO. 5054  
WT. 8.720 TO 9.050 KG./ I2'

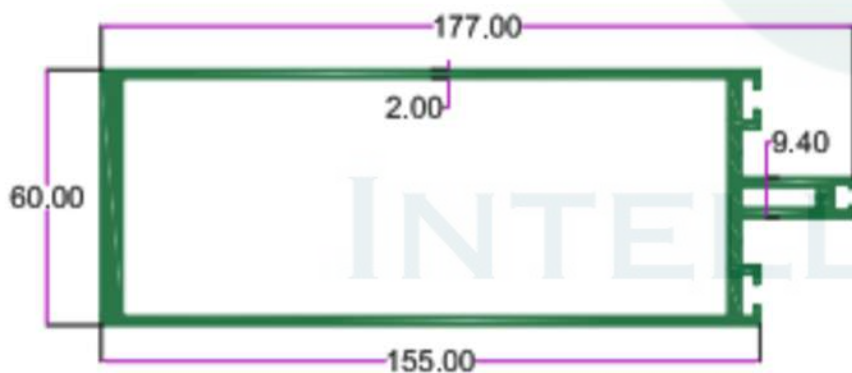

SEC.NO. 5212  
WT. 12.190 TO 12.610 KG/I2'

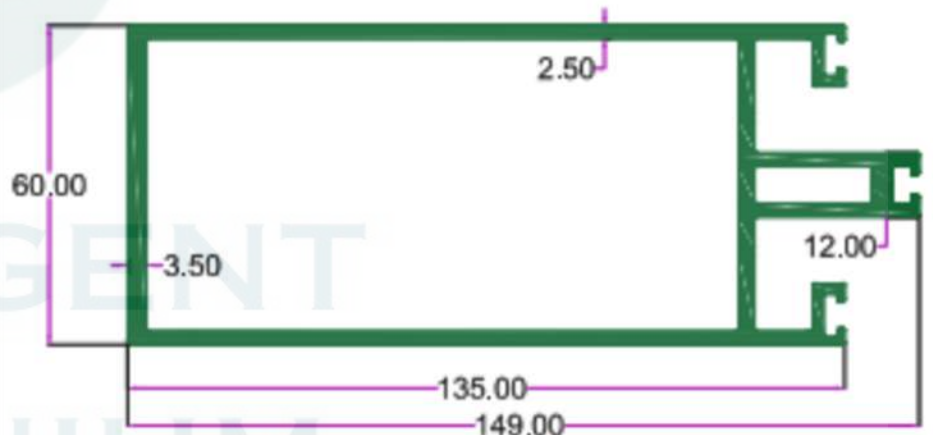

SEC.NO. 5361  
WT. 12.570 TO 12.780 KG/I2'



SEC.NO. 5184  
WT. 20.570 TO 20.990 KG/I2'



SEC.NO. 5362  
WT. 8.390 TO 8.550 KG/I2'

# CURTAIN WALL



INTELLIGENT  
ALUMINIUM

itswallpanel.com

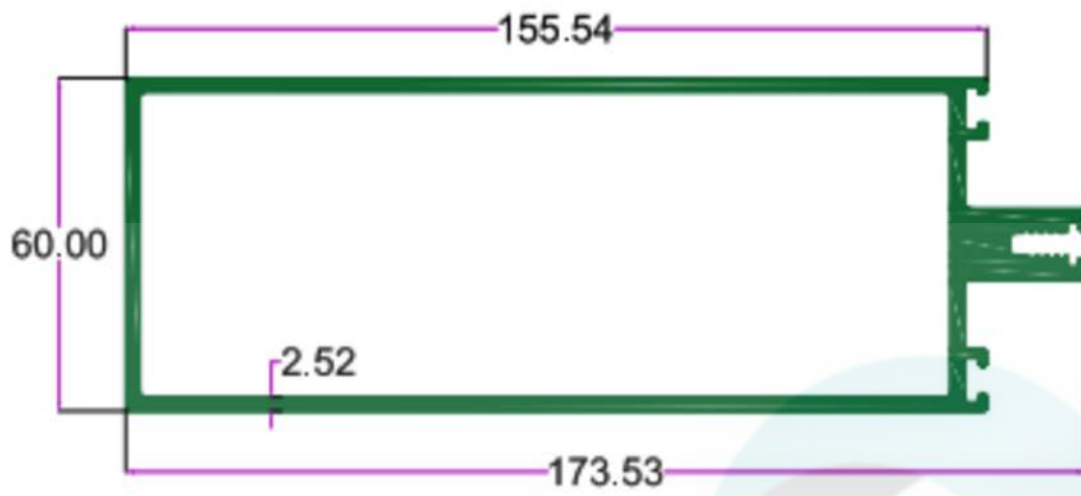

SEC. NO. 4119  
WT. 11.820 TO 12.300 KG/12'

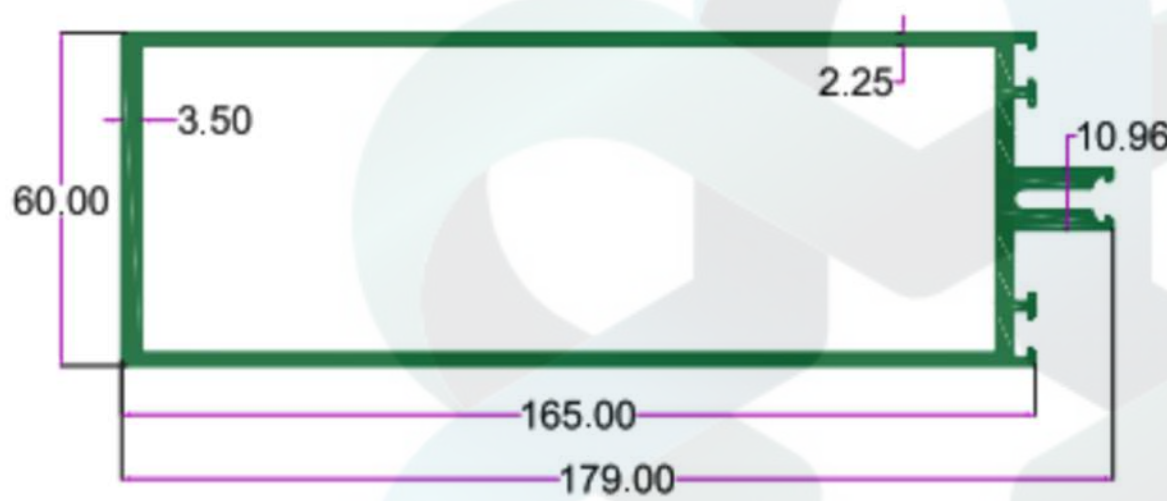

SEC.NO. 4358  
WT. 12.150 TO 12.600 KG/12'



SEC.NO. 4371  
WT. 14.220 TO 14.850 KG/12'

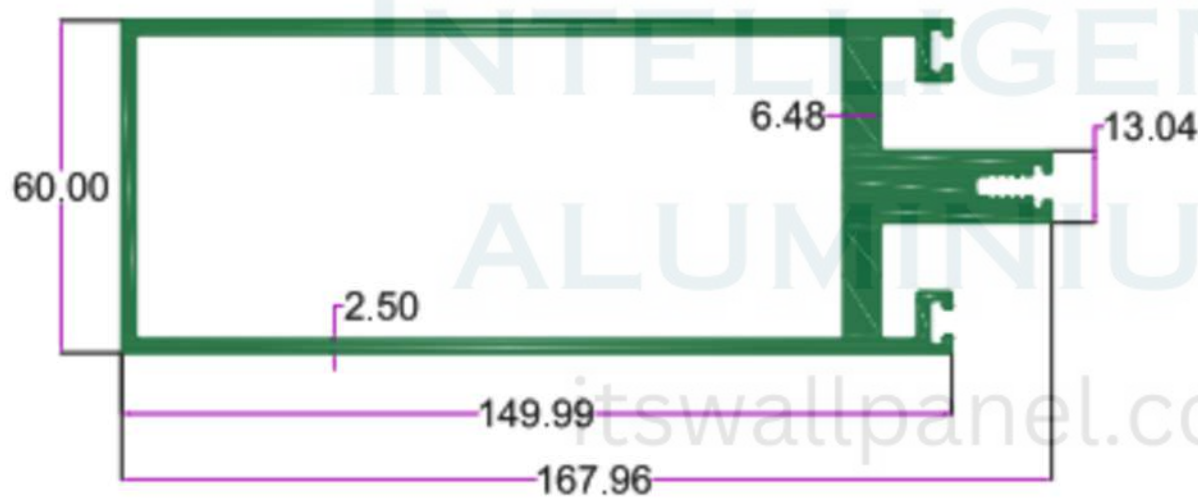

SEC. NO. 4120  
WT. 16.100 TO 16.500 KG/12'

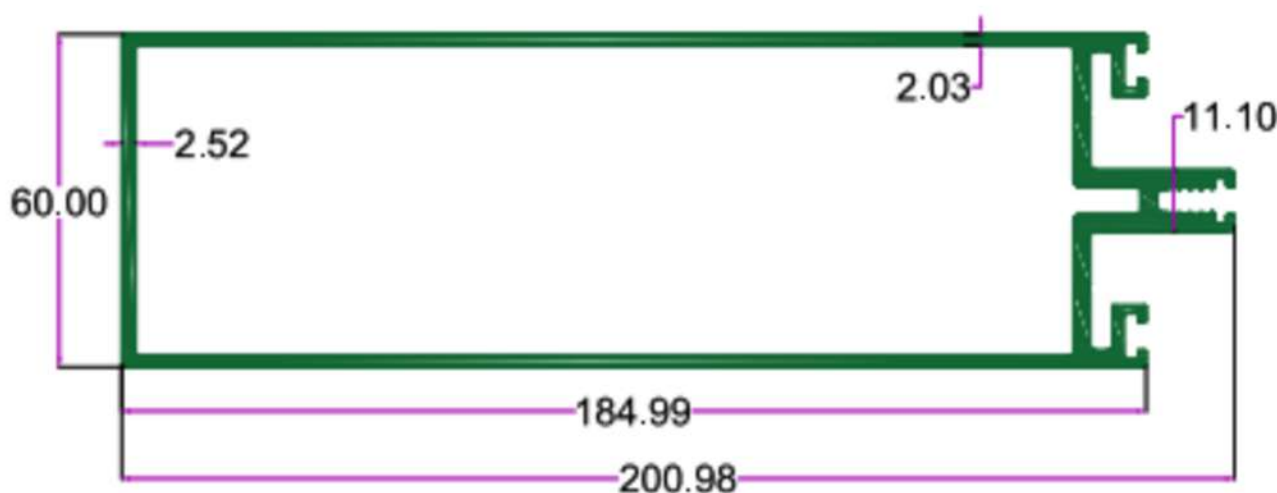

SEC.NO. 5045  
WT. 12.600 TO 13.100 KG/12'



# CURTAIN WALL



INTELLIGENT  
ALUMINIUM

itswallpanel.com

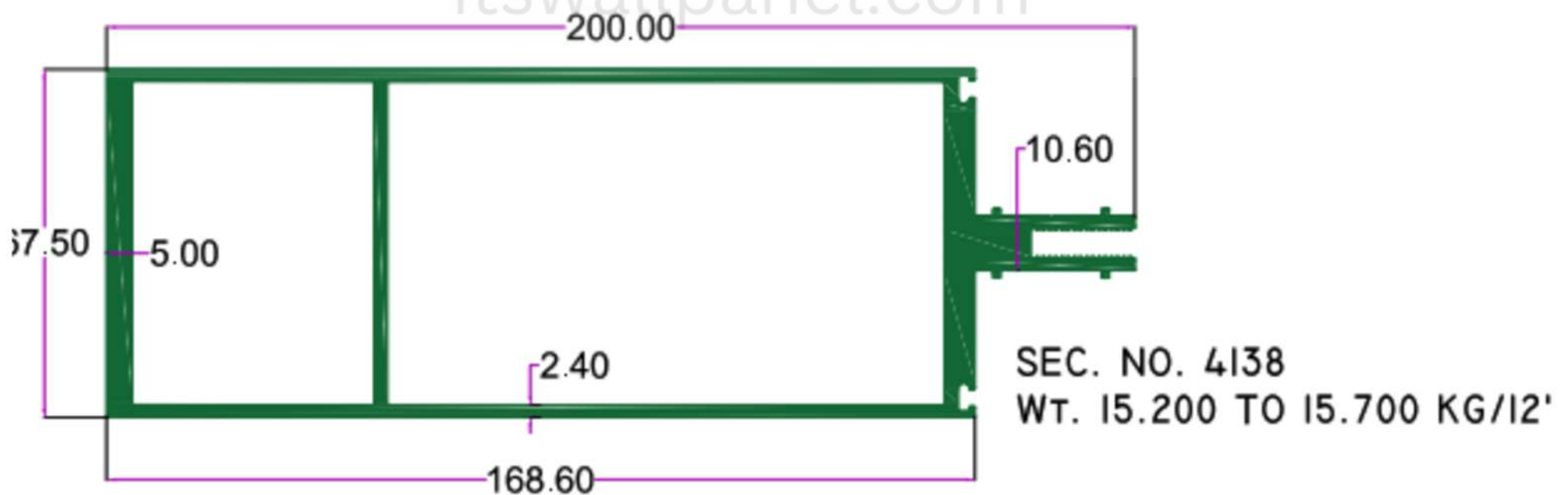
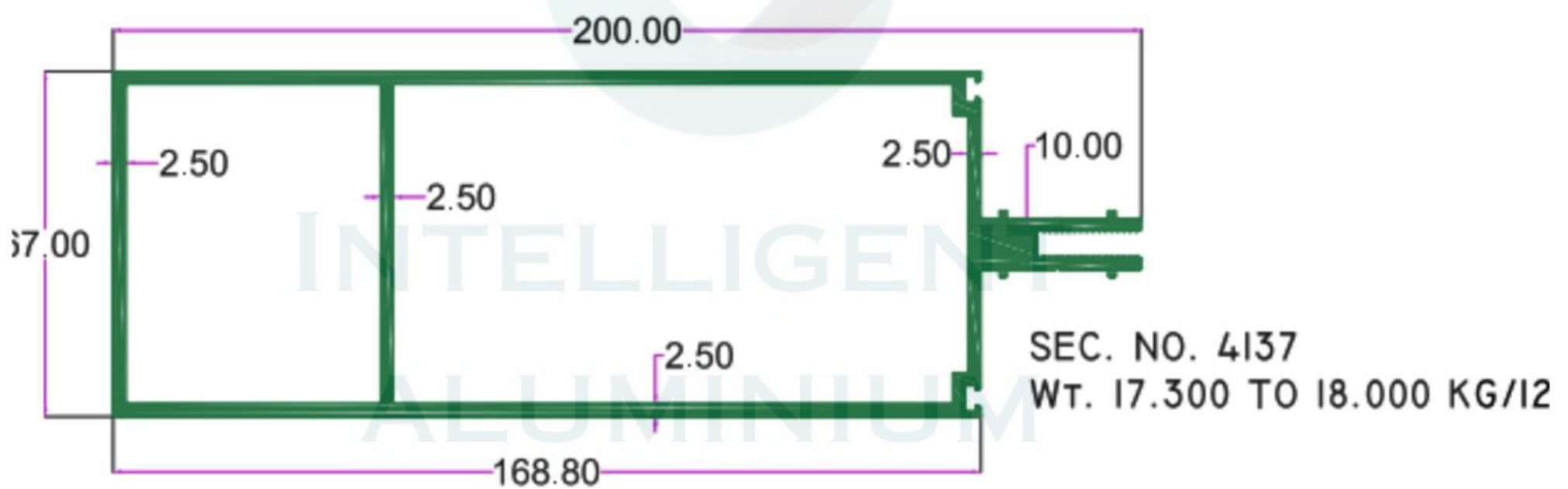
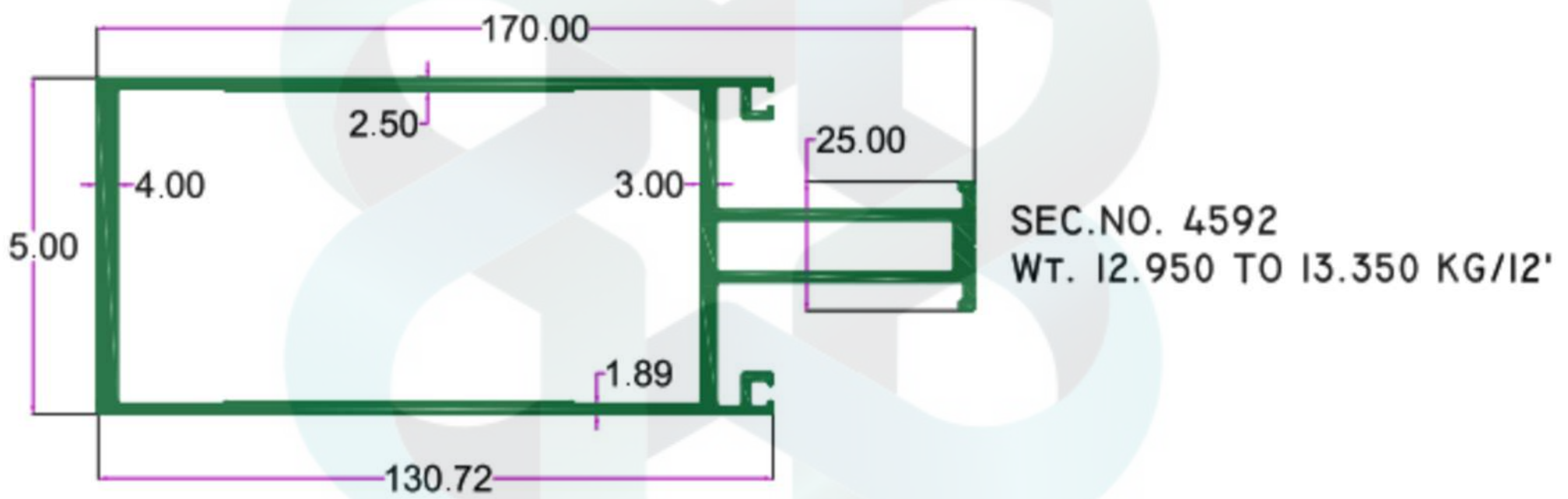
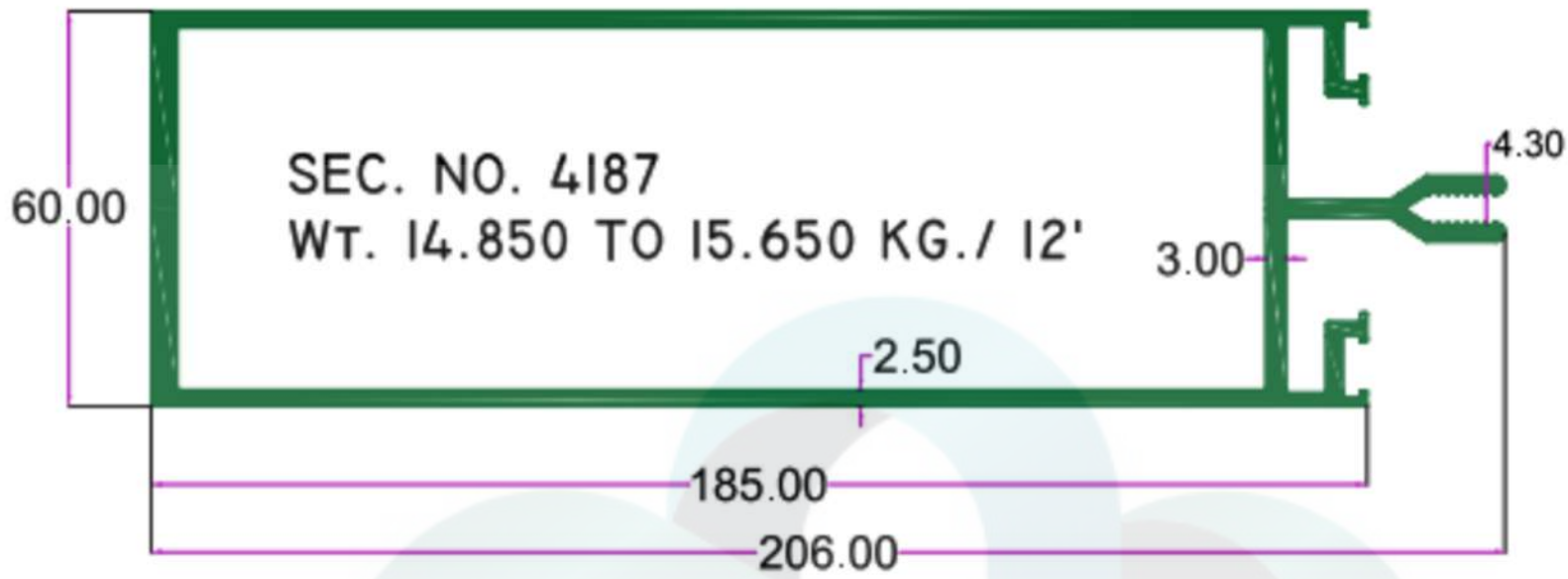

# CURTAIN WALL



INTELLIGENT  
ALUMINIUM  
itswallpanel.com

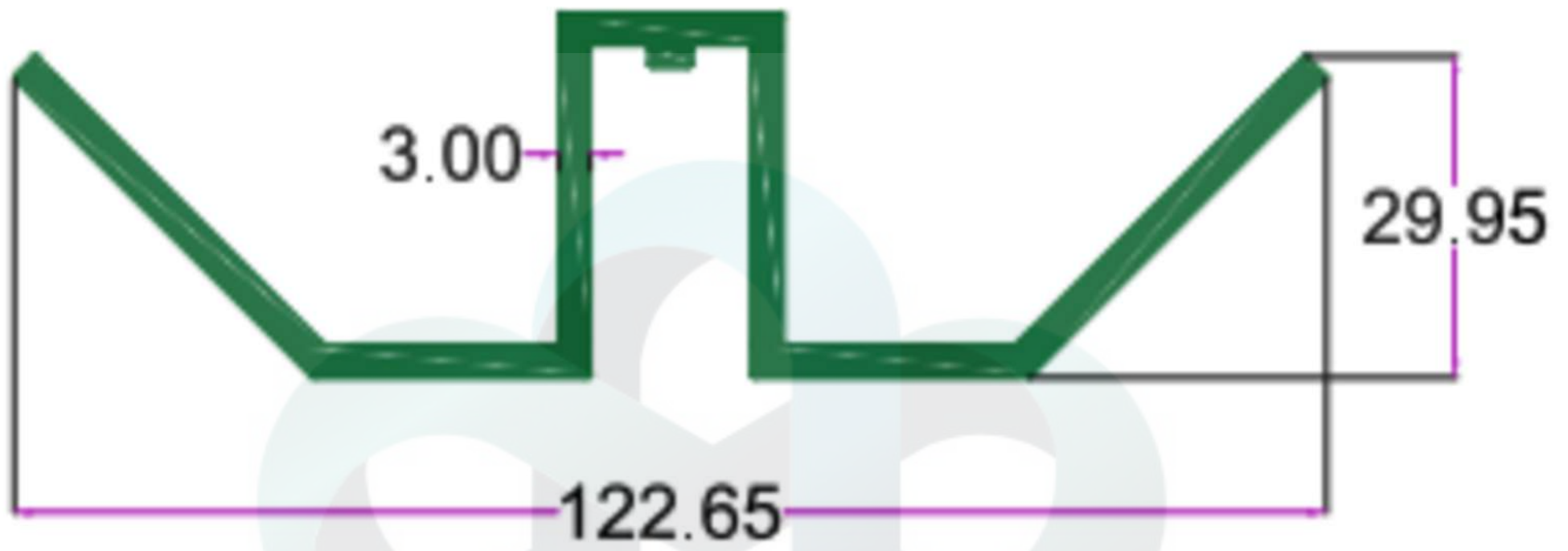

SEC. NO. 5096

WT. 6.170 TO 6.420 KG/12'

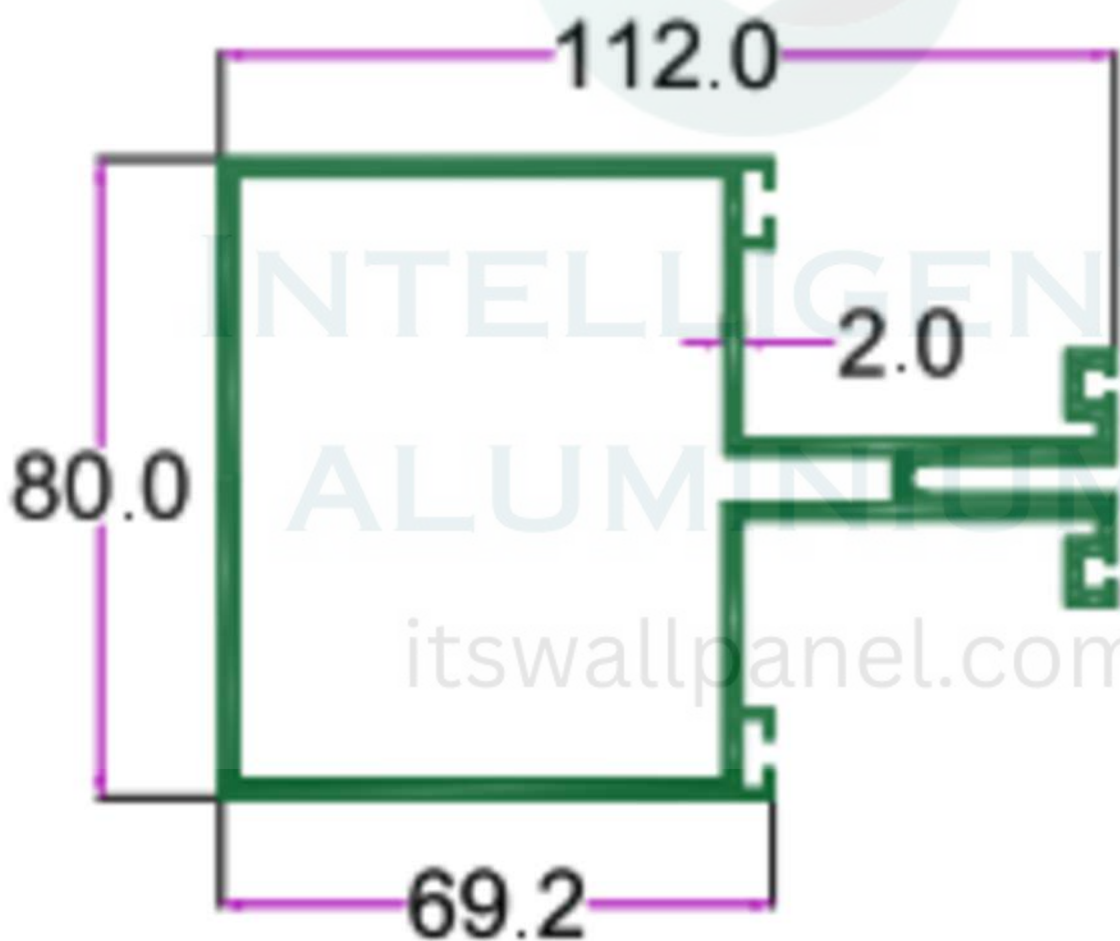

SEC. NO. 2455

WT. 11.300 TO 11.800 KG./ 15'

# CURTAIN WALL



INTELLIGENT  
ALUMINIUM  
itswallpanel.com



SEC.NO. 4360

WT. 1.200 TO 1.400 KG./ 12'

---

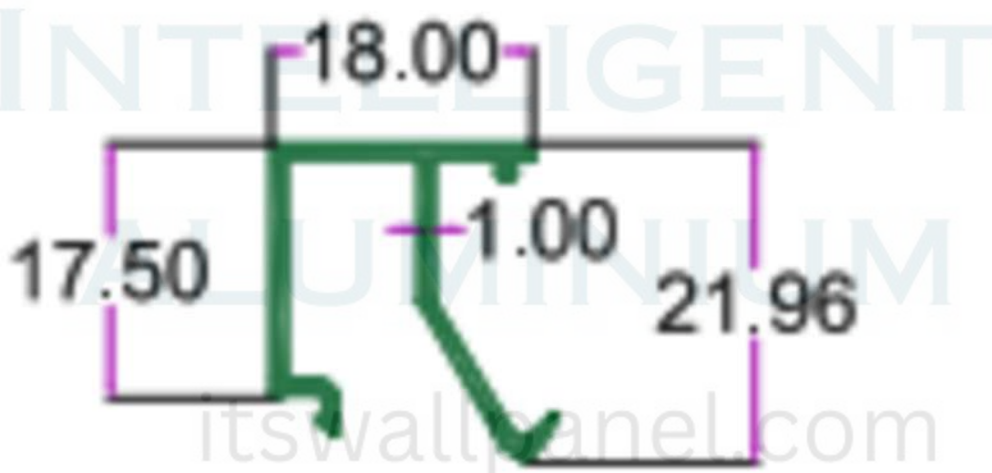

SEC.NO. 4590

WT. 0.650 TO 0.800 KG/12'

# CURTAIN WALL



INTELLIGENT  
ALUMINIUM  
itswallpanel.com

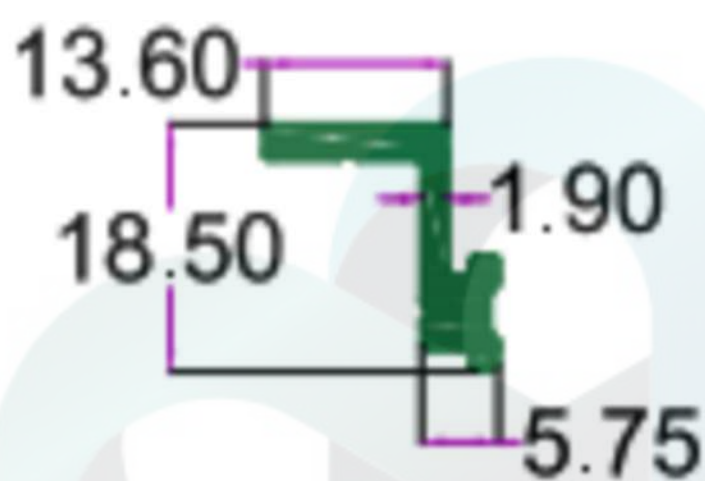

SEC.NO. 4594

WT. 0.860 TO 1.000 KG./ 12'

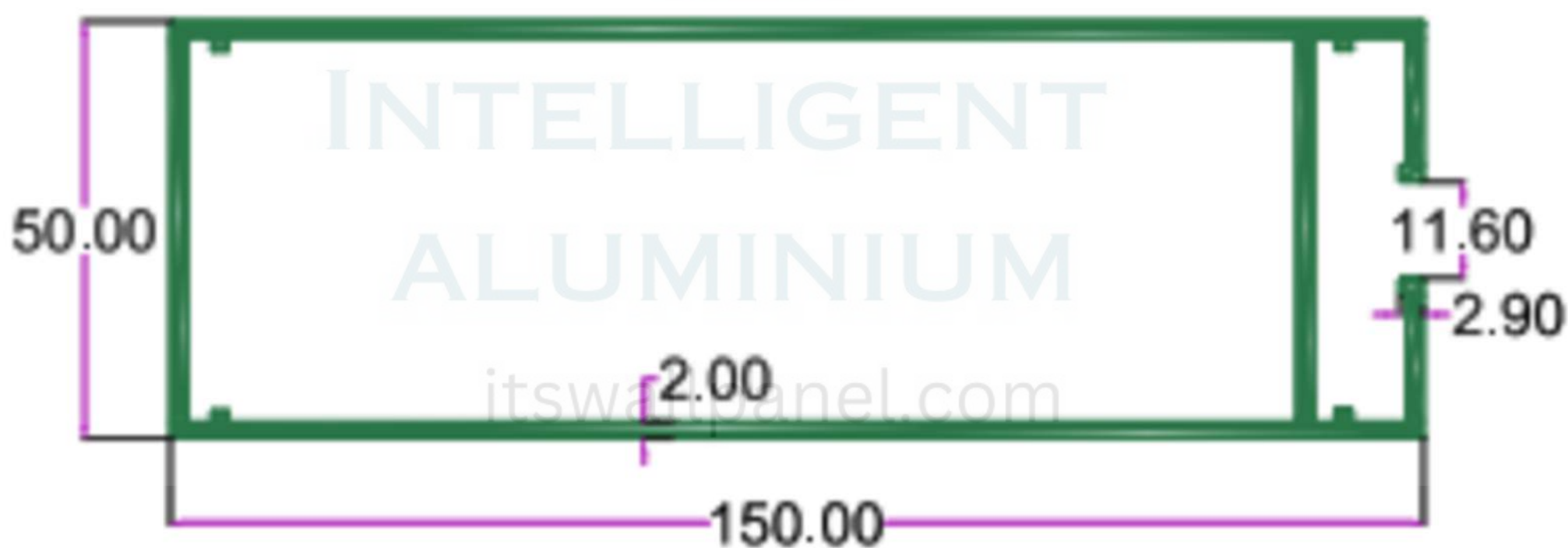

SEC.NO. 4678

WT. 8.580 TO 8.800 KG/12'

# CURTAIN WALL



INTELLIGENT  
ALUMINIUM  
itswallpanel.com

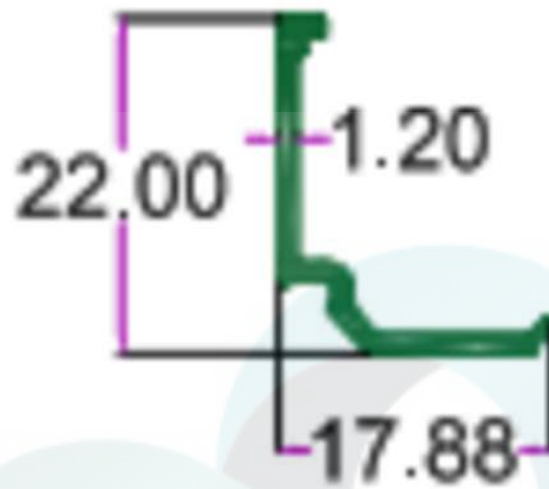

SEC.NO. 4591

WT. 0.450 TO 0.600 KG/12'

---

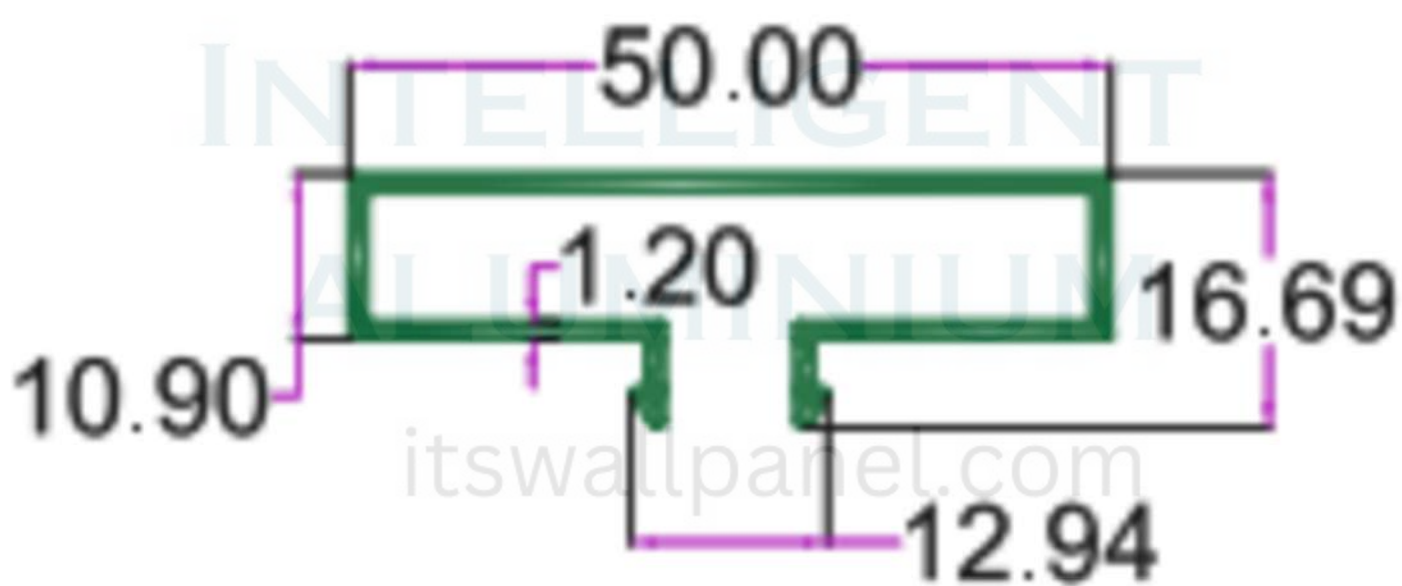

SEC.NO. 4679

WT. 1.440 TO 1.650 KG/12'

# CURTAIN WALL



INTELLIGENT  
ALUMINIUM

itswallpanel.com



SEC.NO. 4672  
WT. 10.140 TO 10.350 KG/12'

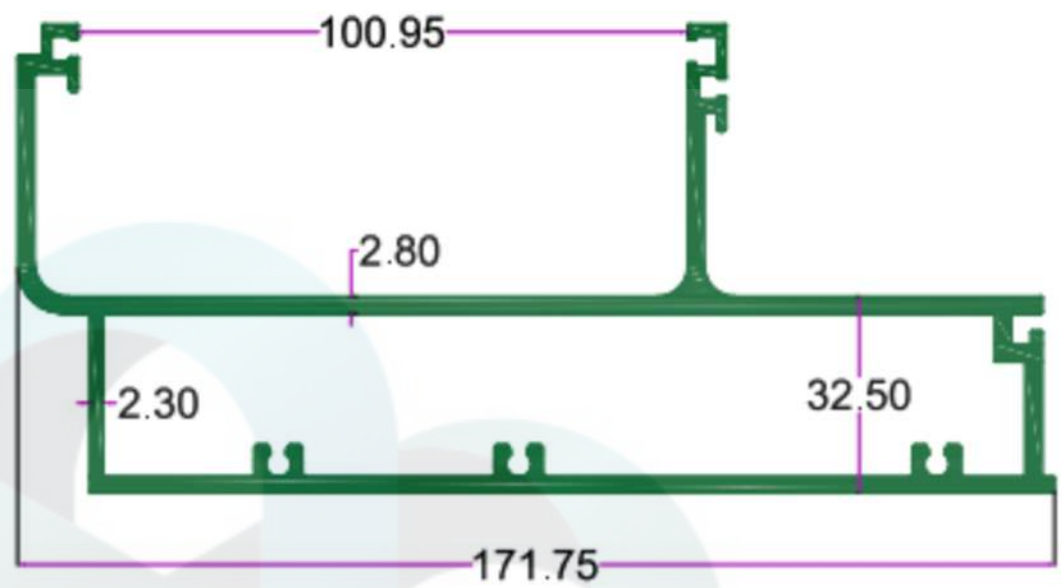

SEC.NO. 4986  
WT. 14.050 TO 14.600 KG/12'

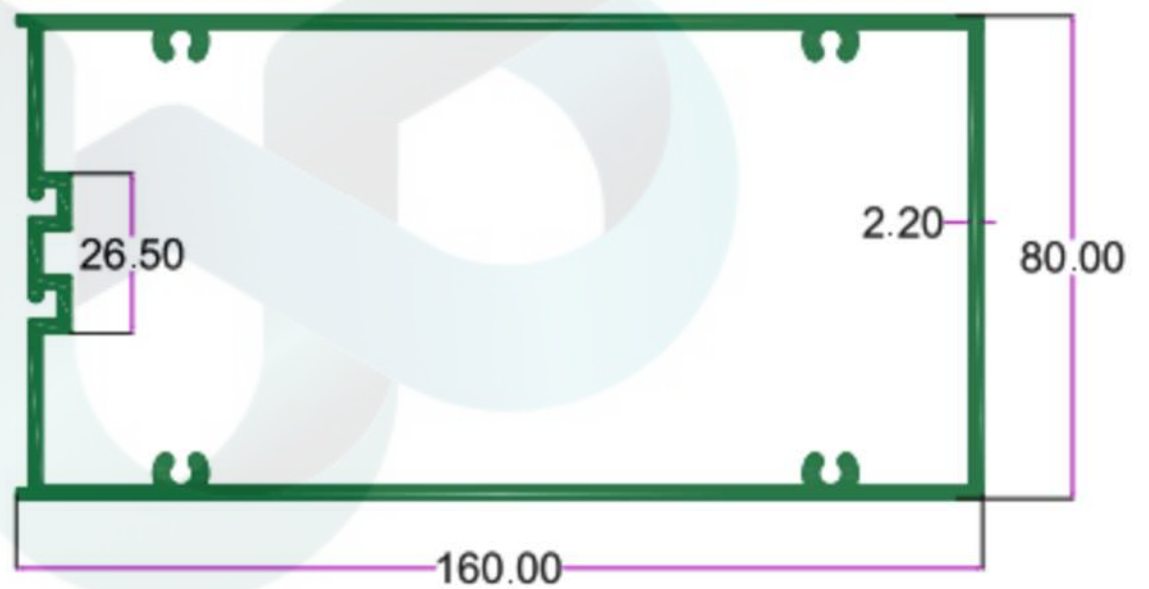

SEC.NO. 4987  
WT. 11.770 TO 12.400 KG/12'

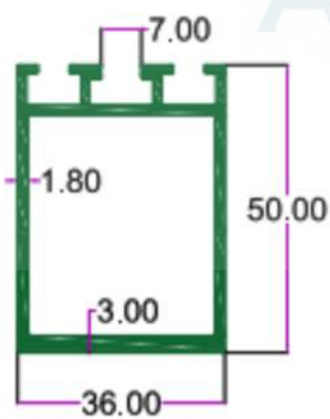

SEC.NO. 4694  
WT. 3.210 TO 3.350 KG/12'

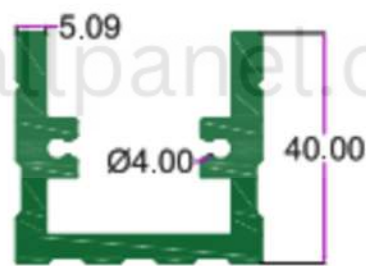

SEC.NO. 5221  
WT. 12.850 TO 13.270 KG/12'

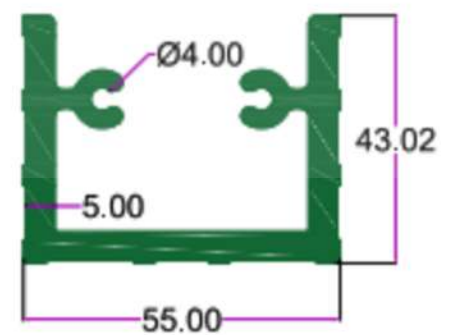

SEC.NO. 5220  
WT. 7.850 TO 8.100 KG/12'

# CURTAIN WALL



INTELLIGENT  
ALUMINIUM

itswallpanel.com

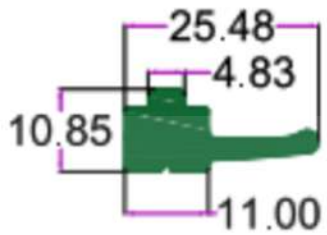

SEC.NO. 4684  
WT. 1.380 TO 1.550 KG/12'

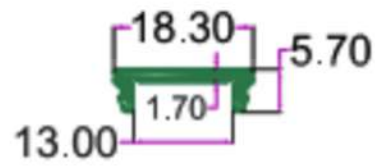

SEC.NO. 5226  
WT. 0.440 TO 0.690 KG/12'

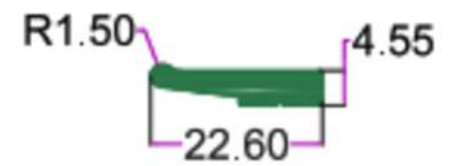

SEC.NO. 4276  
WT. 0.800 TO 1.000 KG/12'

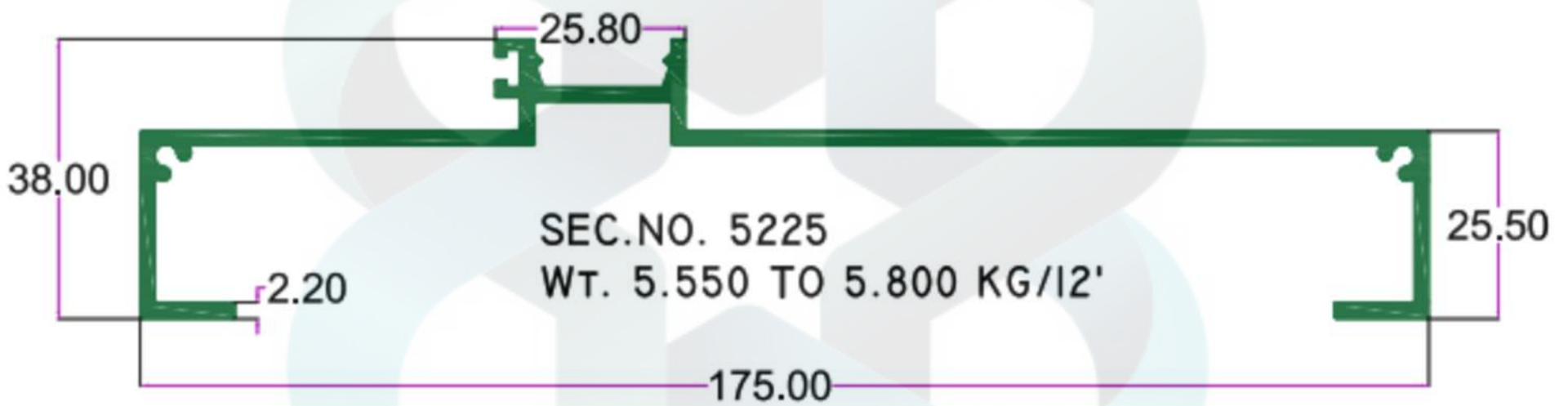

SEC.NO. 5225  
WT. 5.550 TO 5.800 KG/12'

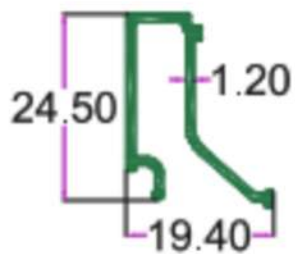

SEC.NO. 4802  
WT. 0.800 TO 0.900 KG/12'



SEC.NO. 4673  
WT. 6.700 TO 6.900 KG/12'

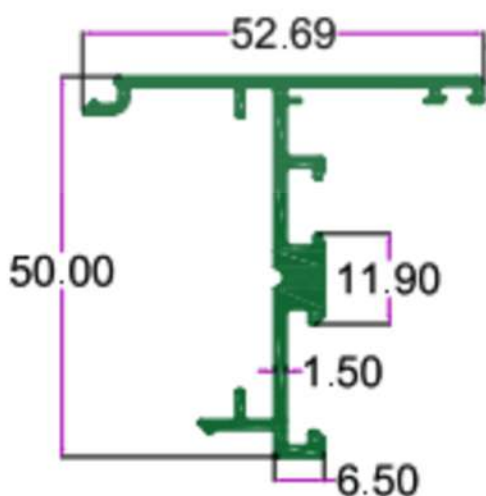

SEC.NO. 4804  
WT. 2.380 TO 2.600 KG/12'

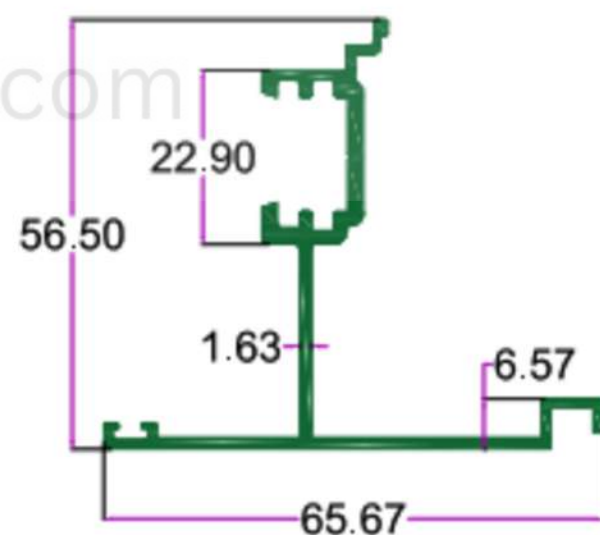

SEC.NO. 4803  
WT. 2.610 TO 2.850 KG/12'

# CURTAIN WALL



**INTELLIGENT  
ALUMINIUM**

itswallpanel.com

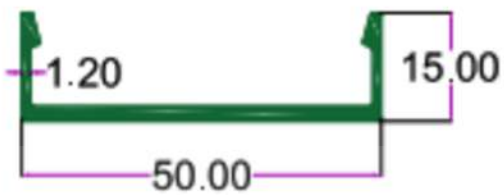

SEC.NO. 5029  
WT. 1.370 TO 1.550 KG/12'

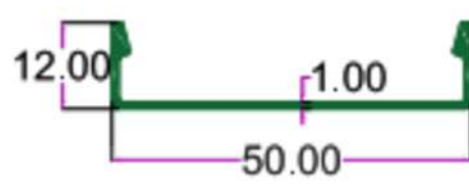

SEC.NO. 5030  
WT. 0.800 TO 0.900 KG/12'

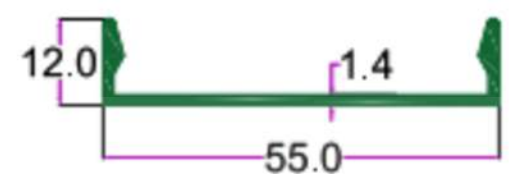

SEC. NO. 2428  
WT. 1.200 TO 1.400 KG/12'

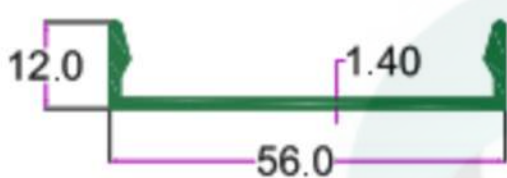

SEC. NO. 2429  
WT. 1.650 TO 1.850 KG/15'

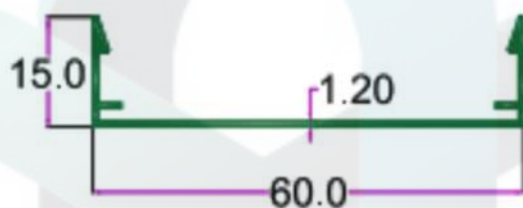

SEC. No. 2441  
WT. 0.800 TO 0.900 KG/12'

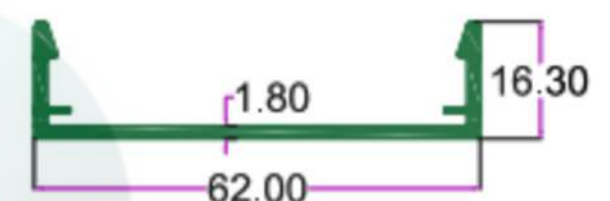

SEC.NO. 4480  
WT. 1.730 TO 2.000 KG/12'

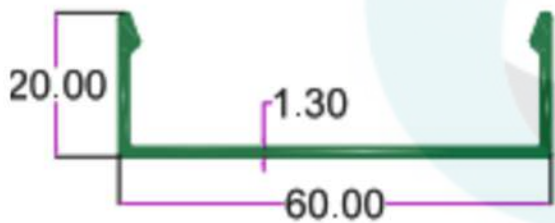

SEC. NO. 4114  
WT. 1.300 TO 1.450 KG/12'

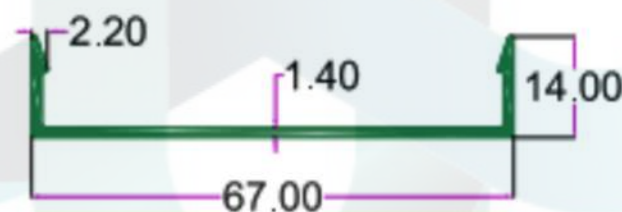

SEC.NO. 5314  
WT. 0.250 TO 0.500 KG/12'

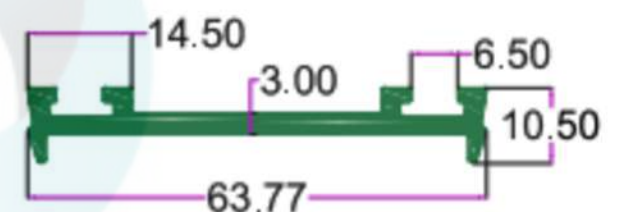

SEC.NO. 5315  
WT. 2.360 TO 2.610 KG/12'

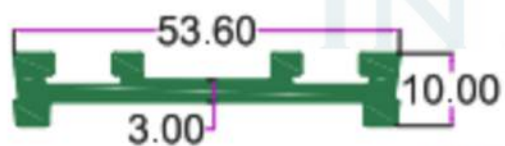

SEC.NO. 5218  
WT. 2.375 TO 2.625 KG/12'



SEC. NO. 2427  
WT. 2.700 TO 2.900 KG/15'

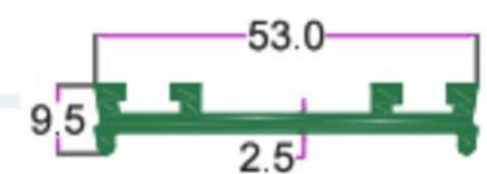

SEC. NO. 2426  
WT. 2.300 TO 2.550 KG/15'

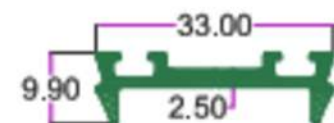

SEC.NO. 4674  
WT. 1.020 TO 1.270 KG/12'

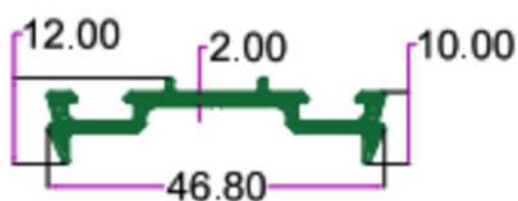

SEC.NO. 5028  
WT. 1.330 TO 1.550 KG/12'

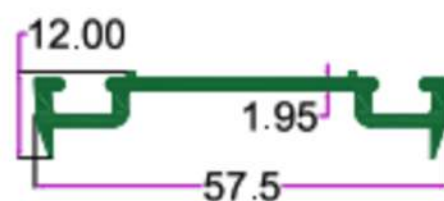

SEC. No. 2440  
WT. 1.400 TO 1.600 KG/12'

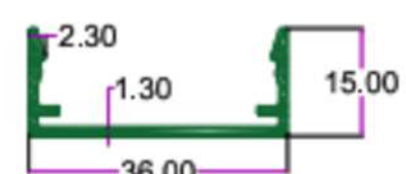

SEC.NO. 4675  
WT. 0.930 TO 1.180 KG/12'



# CURTAIN WALL



INTELLIGENT  
ALUMINIUM  
itswallpanel.com

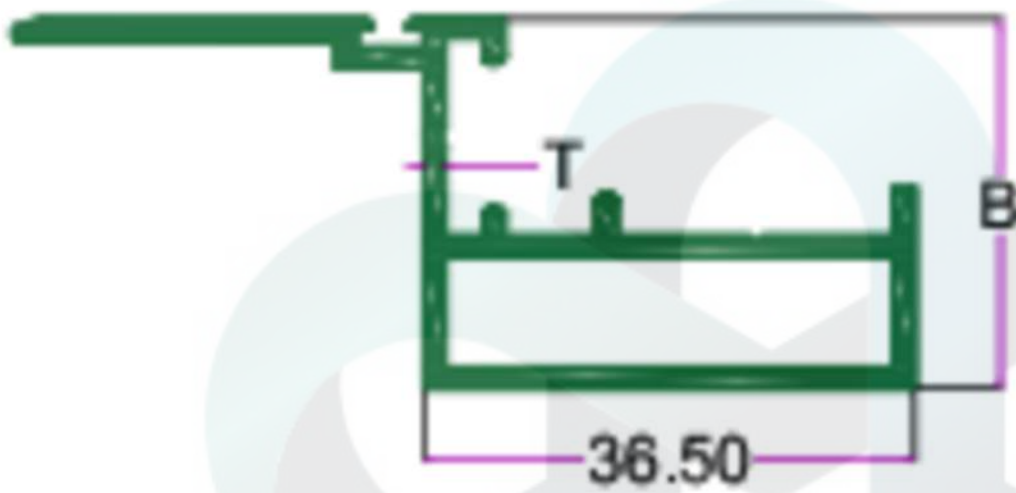

S No.	SECTION No.	A IN MM.	B IN MM.	T IN MM.	WEIGHT (KG/15')
1	2446 A	67.10	27.50	1.40	2.600-2.900
2	2446 B	67.10	27.50	1.65	3.100-3.300
3	2446 C	67.10	27.50	1.90	3.400-3.650

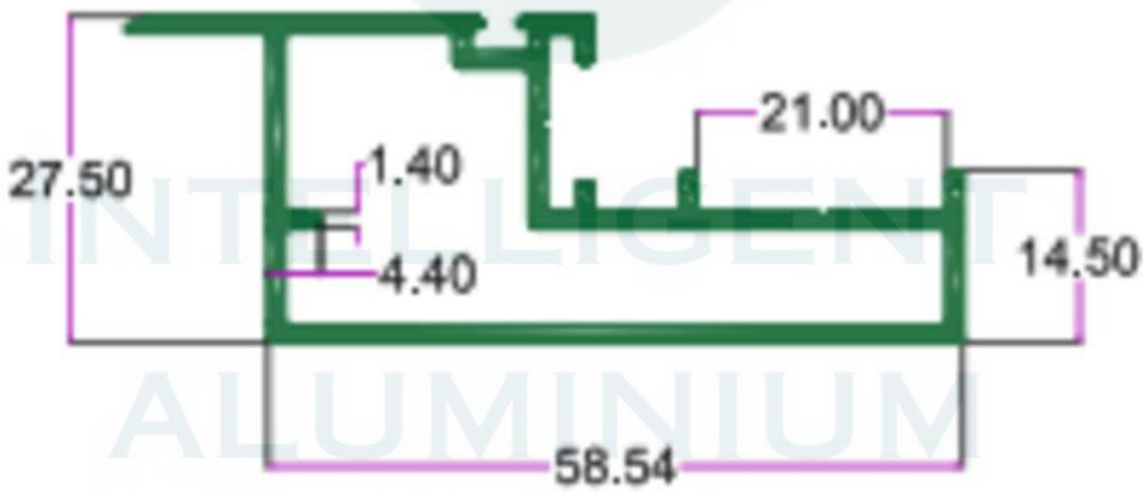

SEC. NO. 4142/D-6383

WT. 2.780 TO 3.00 KG/12'

# CURTAIN WALL



INTELLIGENT  
ALUMINIUM

itswallpanel.com

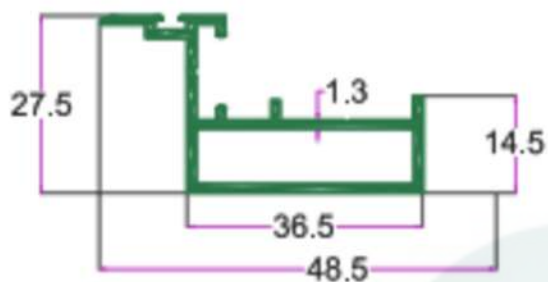

SEC. NO. 2448  
WT. 2.370 TO 2.550 KG/15'

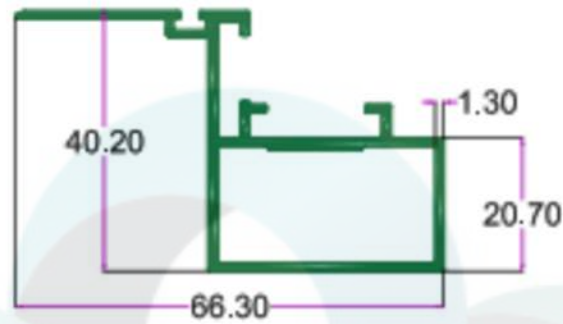

SEC. NO. 4196  
WT. 2.450 TO 2.650 KG/12'

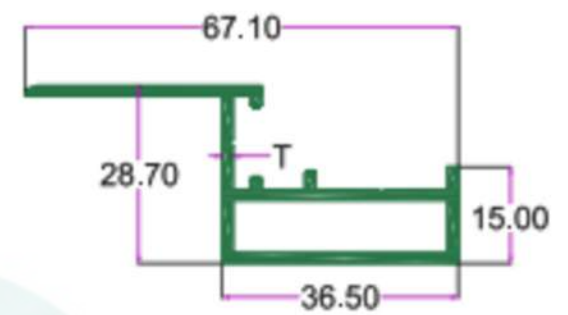

SEC. NO. 2457  
WT. 1.960 TO 2.250 KG/15'



SEC. NO. 2448A  
(L) WT. 2.820 TO 3.000 KG/15'  
(H) WT. 3.120 TO 3.250 KG/15'

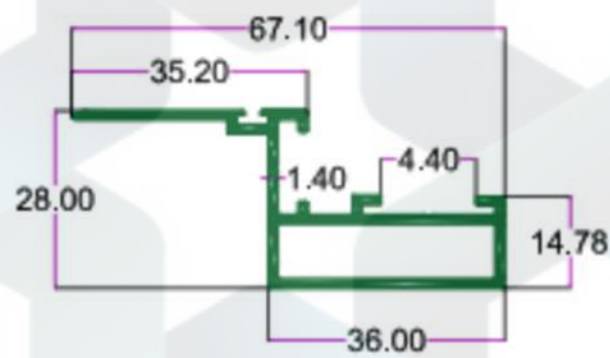

SEC. NO. 2456  
WT. 2.340 TO 2.550 KG/15'



SEC. NO. 2460  
WT. 2.700 TO 2.900 KG/15'

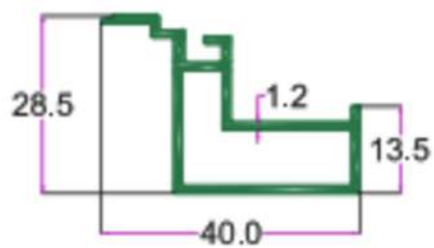

SEC. NO. 3201  
WT. 1.680 TO 1.900 KG/15'

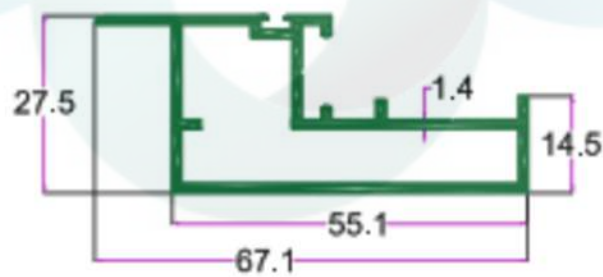

SEC. NO. 2450  
(L) WT. 3.230 TO 3.400 KG/15'  
(H) WT. 4.120 TO 4.250 KG/15'

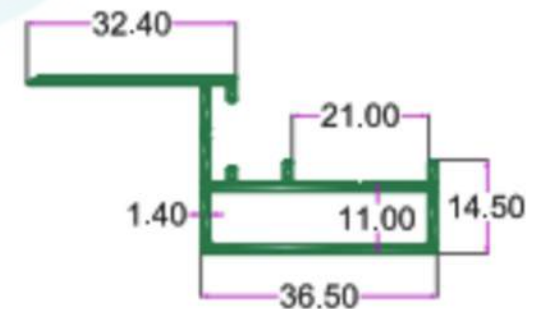

SEC. NO. 4141/D-6859  
WT. 2.040 TO 2.200 KG/12'

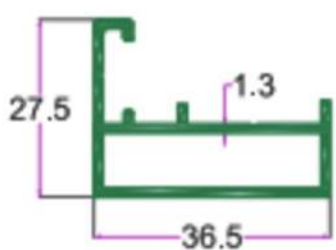

SEC. NO. 2449  
(L) WT. 1.990 TO 2.100 KG/15'  
(H) WT. 3.120 TO 3.300 KG/15'

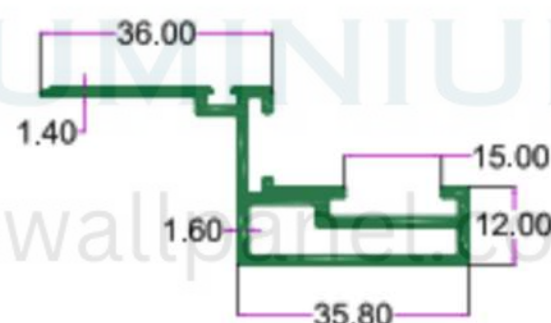

SEC. NO. 4140/D-4629  
WT. 2.370 TO 2.560 KG/12'

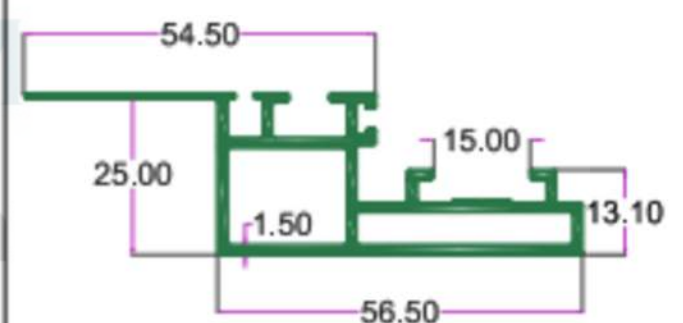

SEC. NO. 4593  
WT. 3.280 TO 3.450 KG/12'

# CURTAIN WALL



INTELLIGENT  
ALUMINIUM

itswallpanel.com

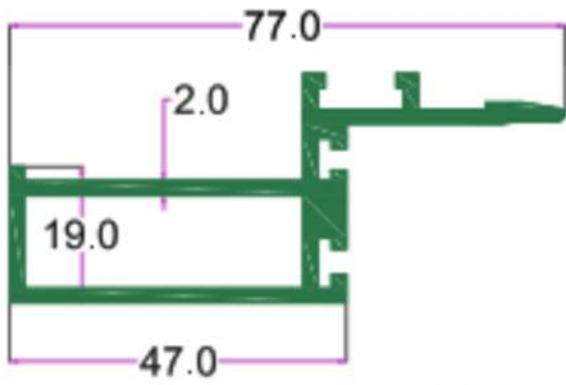

SEC. NO. 2453  
WT. 3.900 TO 4.400 KG/I5'

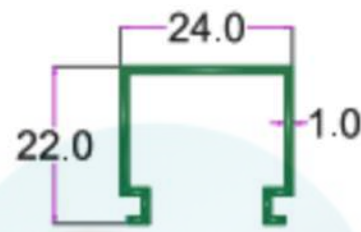

SEC. NO. 2452  
WT. 1.100 TO 1.500 KG/I5'

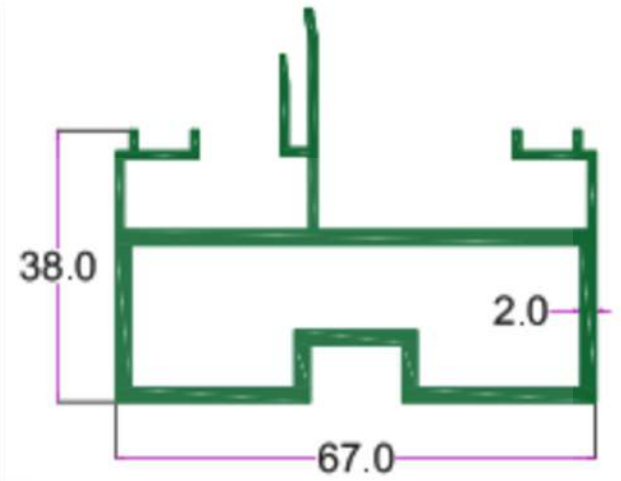

SEC. NO. 245I  
WT. 5.300 TO 5.800 KG/I5'

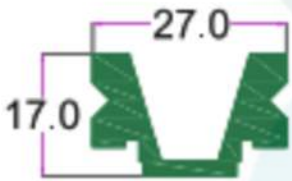

SEC. NO. 2454  
WT. 2.050 TO 2.400 KG/I5'

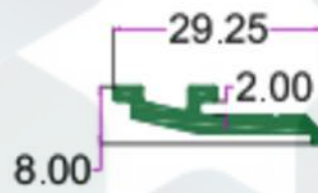

SEC. NO. 4143/D-3033  
WT. 0.830 TO 1.100 KG/I2'

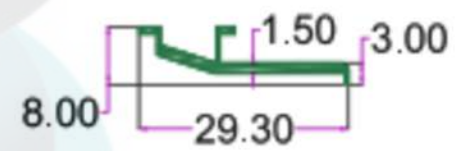

SEC. NO. 2447  
WT 0.450 TO 0.550 KG/I2'

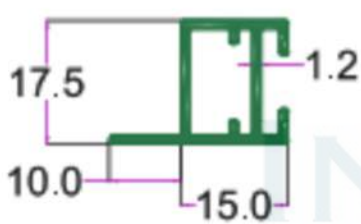

SEC. NO. 2501  
WT. 0.940 TO 1.200 KG/I2'

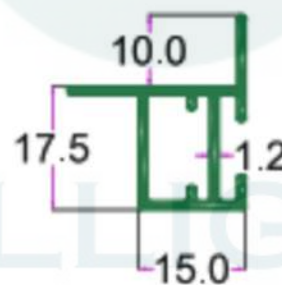

SEC. NO. 2502  
WT. 1.060 TO 1.200 KG/I2'

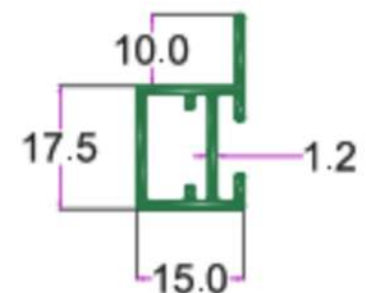

SEC. NO. 2503  
WT. 0.900 TO 1.100 KG/I2'

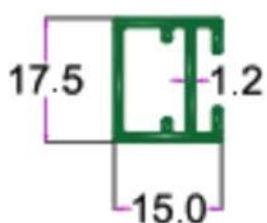

SEC. NO. 2504  
WT. 0.830 TO 1.000 KG/I2'

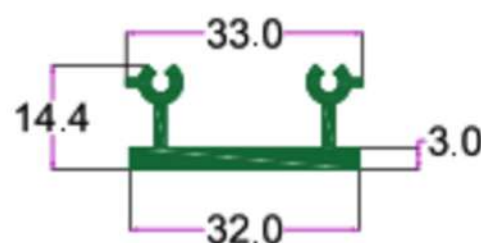

SEC. NO. 2506  
WT. 1.460 TO 1.650 KG/I2'

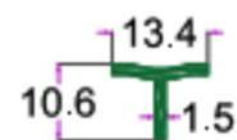

SEC. NO. 2507  
WT. 0.340 TO 0.500 KG/I2'

itswallpanel.com