

LADDER SECTION

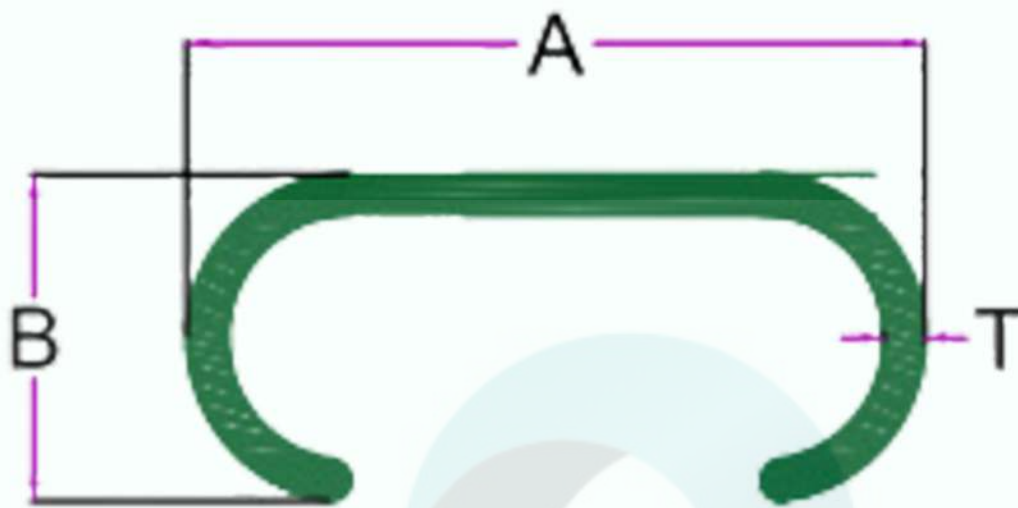

INTELLIGENT
ALUMINIUM
itswallpanel.com



LADDER SECTION

S No.	Section No.	A IN mm.	B IN mm.	T IN mm.	Weight (KG./20')
1	826	66.00	30.00	1.25	2.400-2.500
2	827	66.00	30.00	1.52	2.900-3.000
3	828	66.00	30.00	1.75	3.300-3.500
4	829	66.00	30.00	1.80	3.400-3.500
5	830	66.00	30.00	1.90	3.550-3.700
6	831	66.00	30.00	2.80	5.200-5.400



SEC NO. 854
WT. 3.000 To 3.250 KG/12'

LADDER SECTION



INTELLIGENT
ALUMINIUM
itswallpanel.com

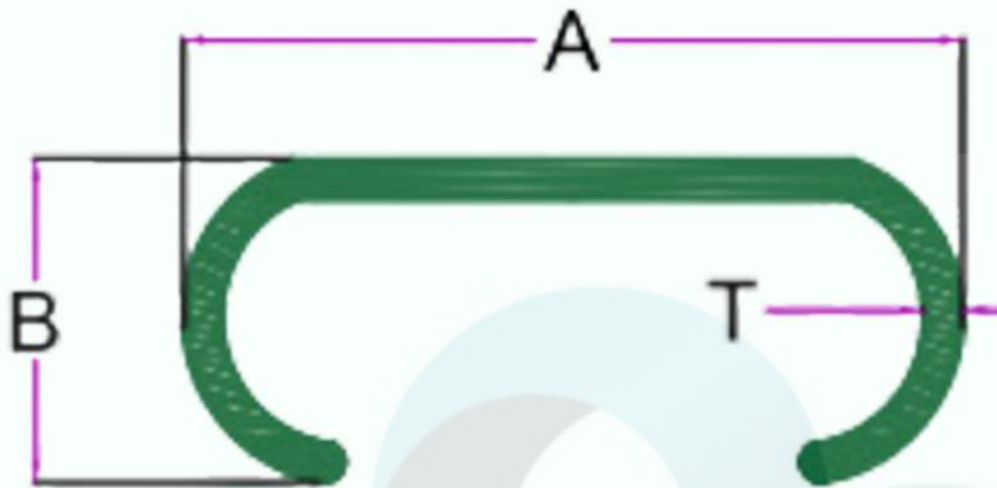

LADDER SECTION

S No.	Section No.	A IN mm.	B IN mm.	T IN mm.	Weight (KG./20')
1	839	65.53	31.50	1.85	3.550-3.900
2	840	65.53	31.50	2.05	4.000-4.200
3	841	65.53	31.50	2.41	4.700-4.900
4	842	65.53	31.50	2.50	5.000-5.300
5	843	65.53	31.50	2.80	5.400-5.800
6	837	65.53	31.50	3.00	5.900-6.200
7	845	65.53	31.50	3.10	5.800-6.000
8	846	65.53	31.50	3.30	6.300-6.600
9	847	65.53	31.50	3.90	7.300-7.500
10	850	66.20	31.30	1.40	1.800-2.000
11	851	66.20	29.50	1.60	2.050-2.200
12	5001	66.20	31.30	0.90	1.800-1.950
13	5002	66.20	31.30	1.00	2.250-2.500
14	5003	66.20	31.30	1.40	2.700-2.850
15	5004	66.20	29.50	1.60	3.000-3.150
16	5005	66.20	29.50	1.60	3.300-3.450

LADDER SECTION



INTELLIGENT
ALUMINIUM
itswallpanel.com

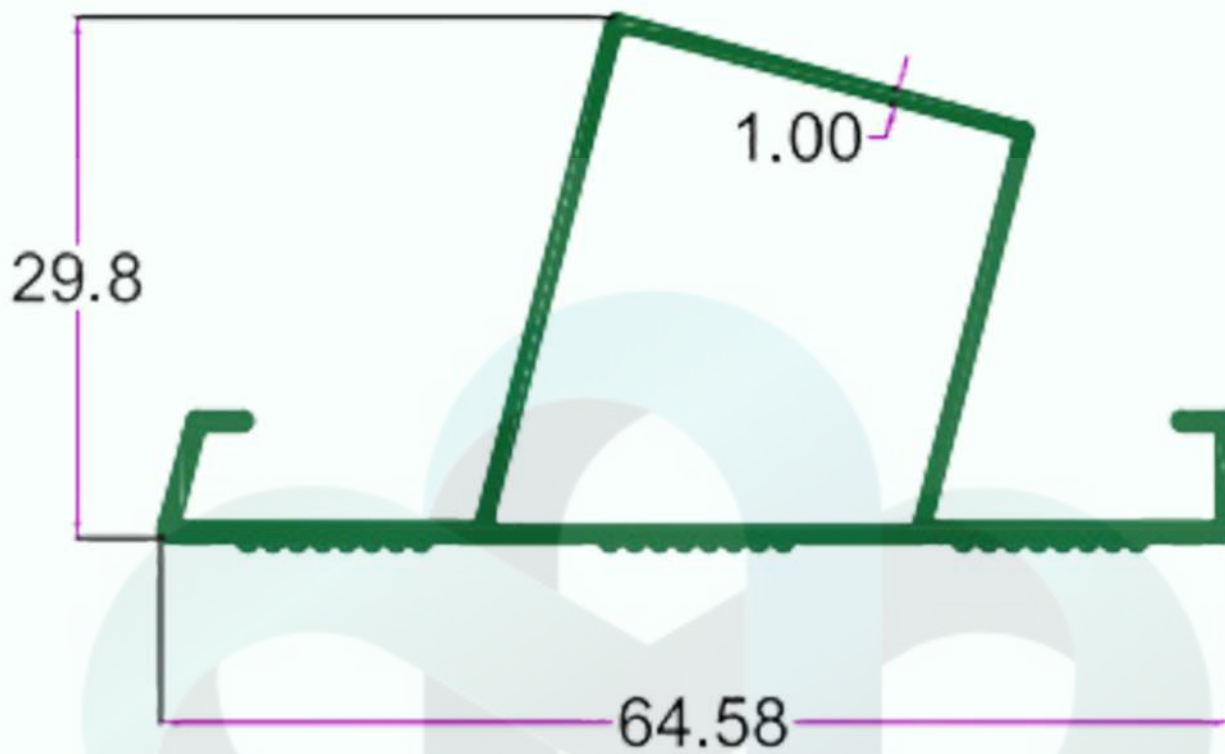

SEC NO. 853

WT. 1.390 TO 1.600 KG/12'

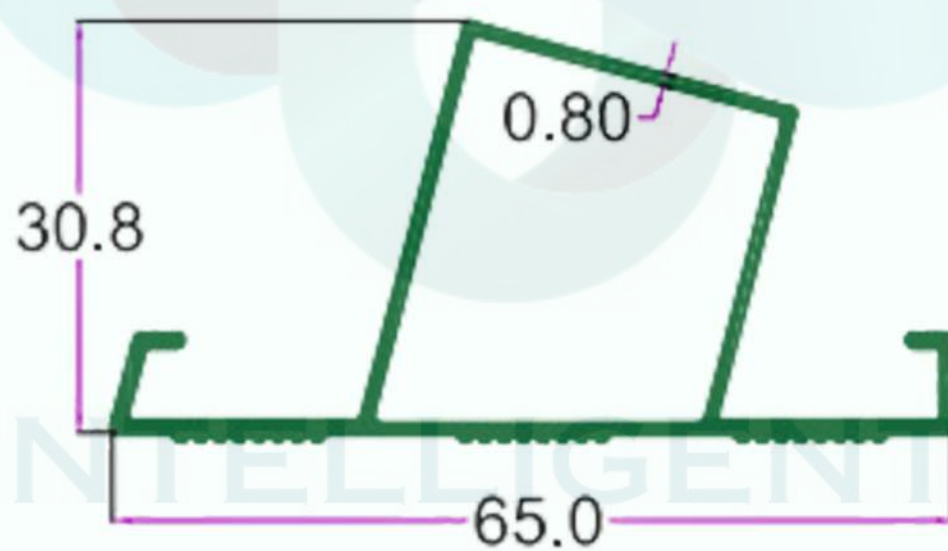

SEC NO. 851

WT. 1.300 TO 1.550 KG/12'

SEC NO. 852

WT. 1.500 TO 1.70 KG/12'

SEC NO. 852

WT. 2.200 TO 2.400 KG/12'

SEC NO. 856

WT. 2.500 TO 2.800 KG/12'

LADDER SECTION



INTELLIGENT
ALUMINIUM
itswallpanel.com

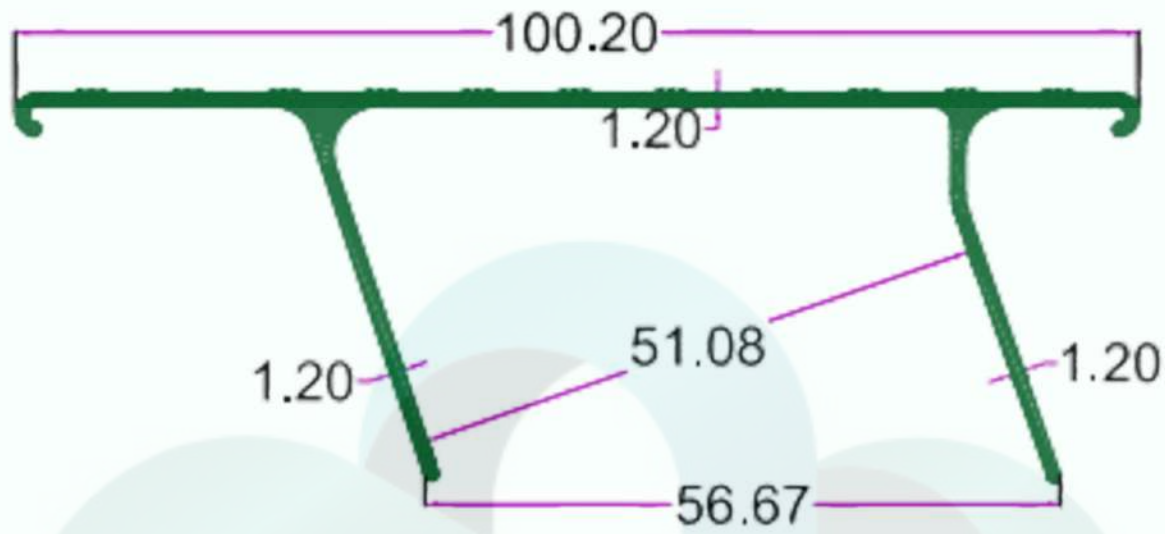

SEC. NO. 4083
WT. 2.200 TO 2.350 KG/12'

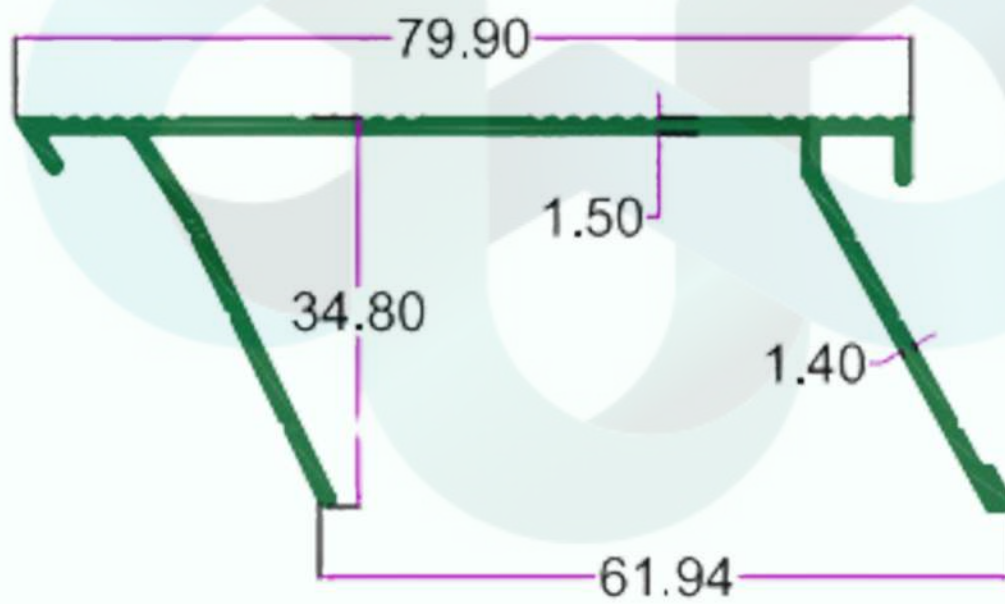

SEC. NO. 4091
WT. 2.250 TO 2.400 KG/12'



SEC. NO. 3820
WT. 2.150 TO 2.300 KG/12'

LADDER SECTION



INTELLIGENT
ALUMINIUM
itswallpanel.com

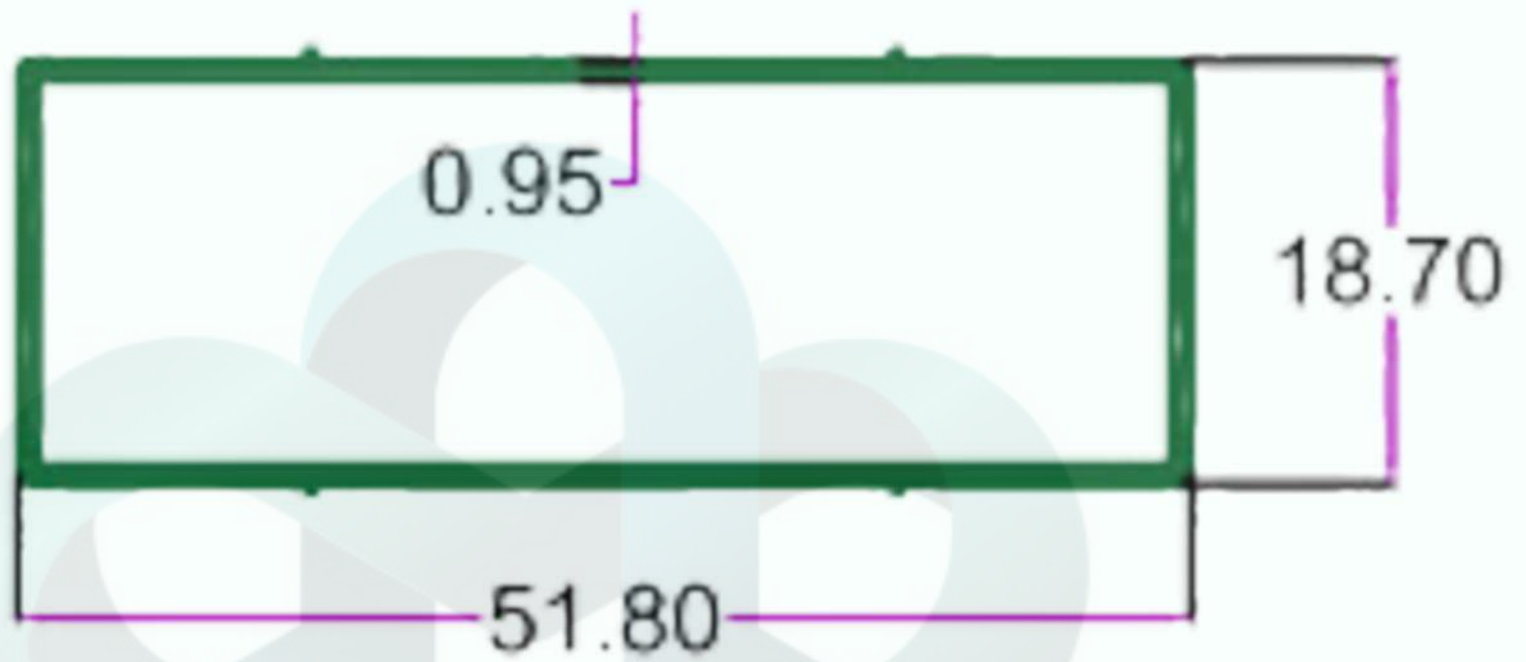

SEC. NO. 3818

WT. 1.200 TO 1.300 KG/12'

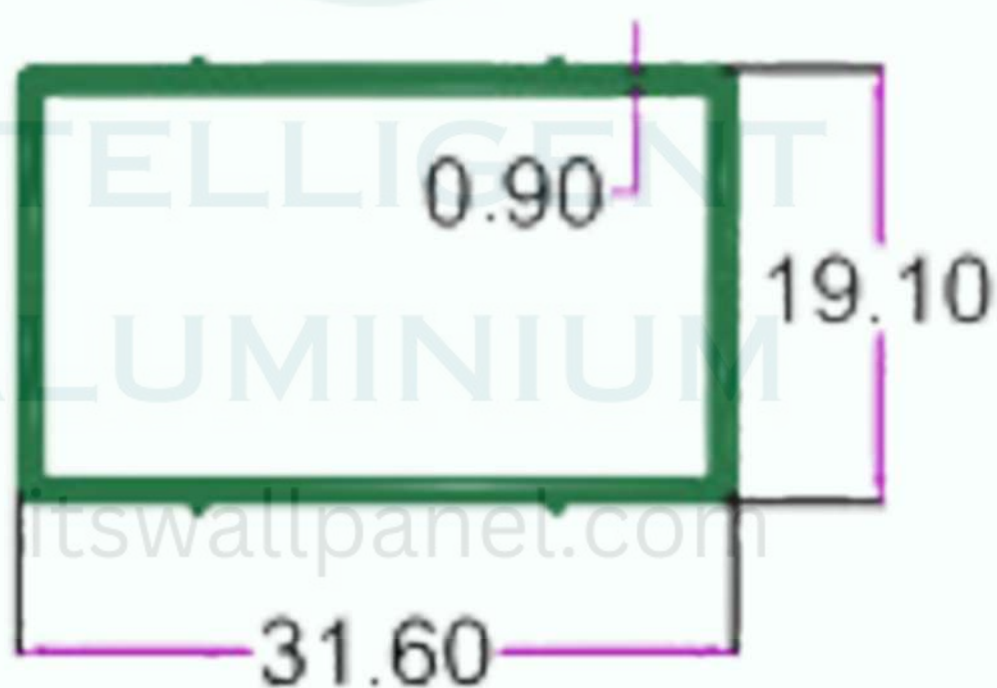

SEC. NO. 3819

WT. 0.800 TO 1.000 KG/12'

LADDER SECTION



INTELLIGENT
ALUMINIUM
itswallpanel.com

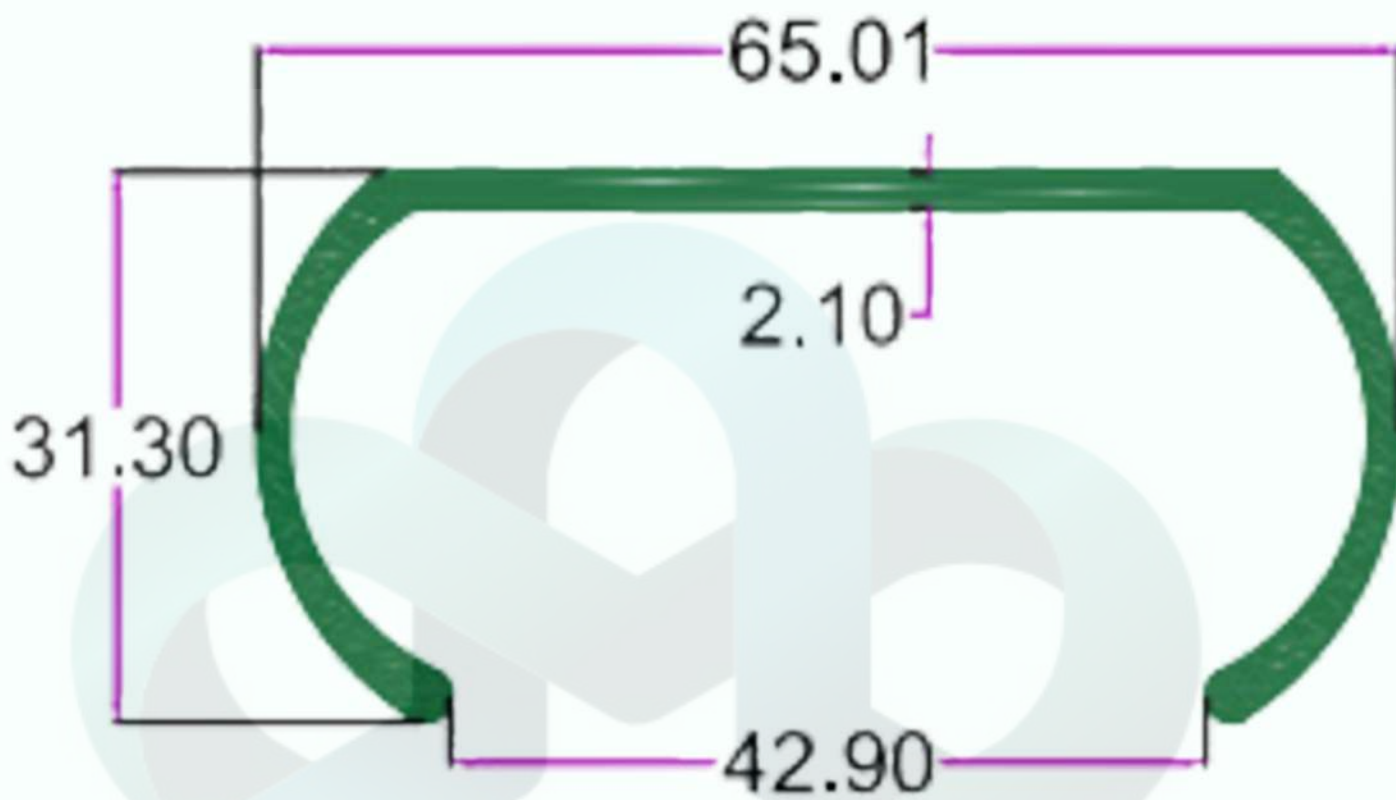

SEC.NO. 4519

WT. 2.530 TO 2.650 KG/12'

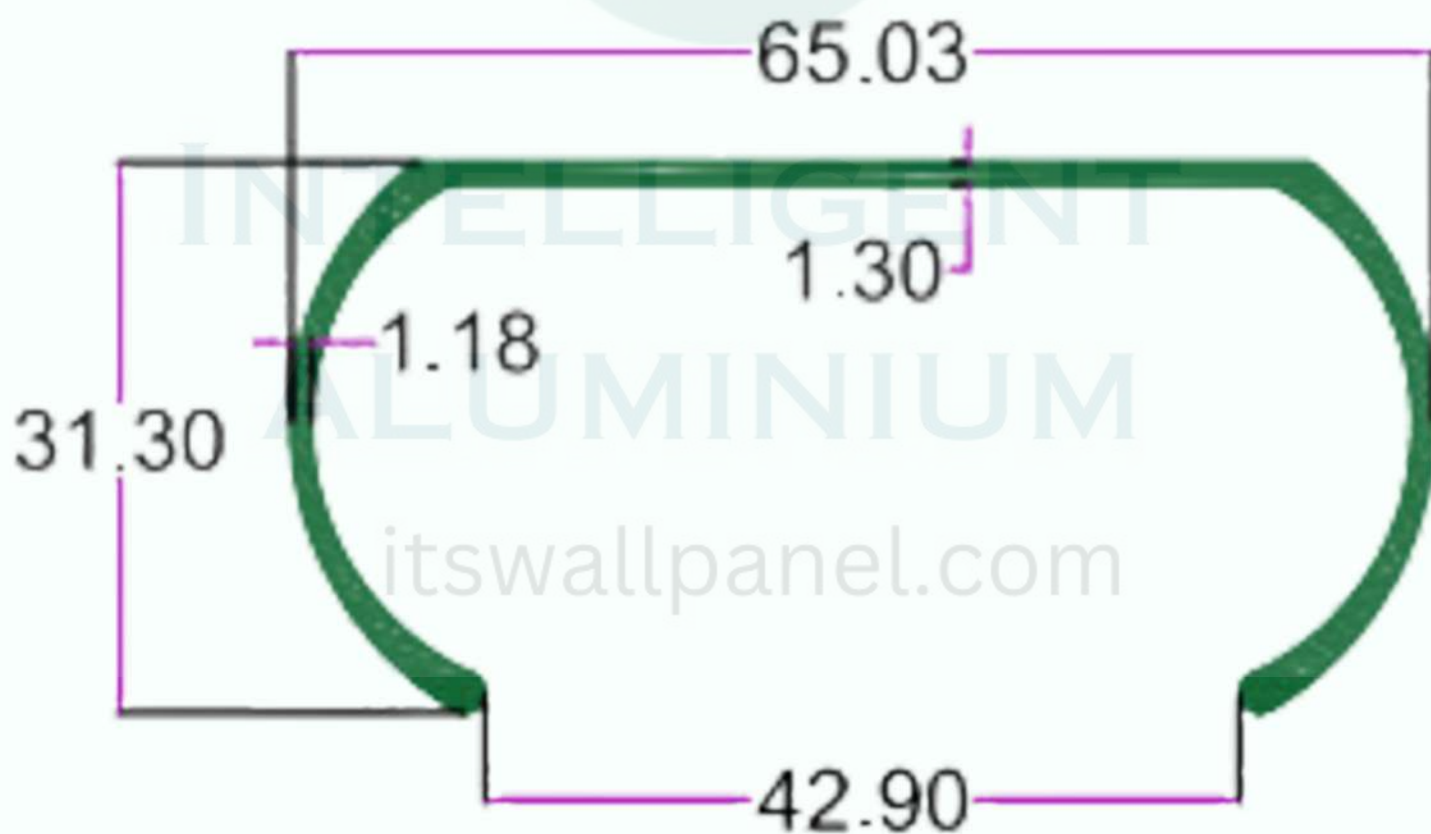

SEC.NO. 4520

WT. 1.740 TO 1.850 KG/12'

LADDER SECTION



INTELLIGENT
ALUMINIUM
itswallpanel.com

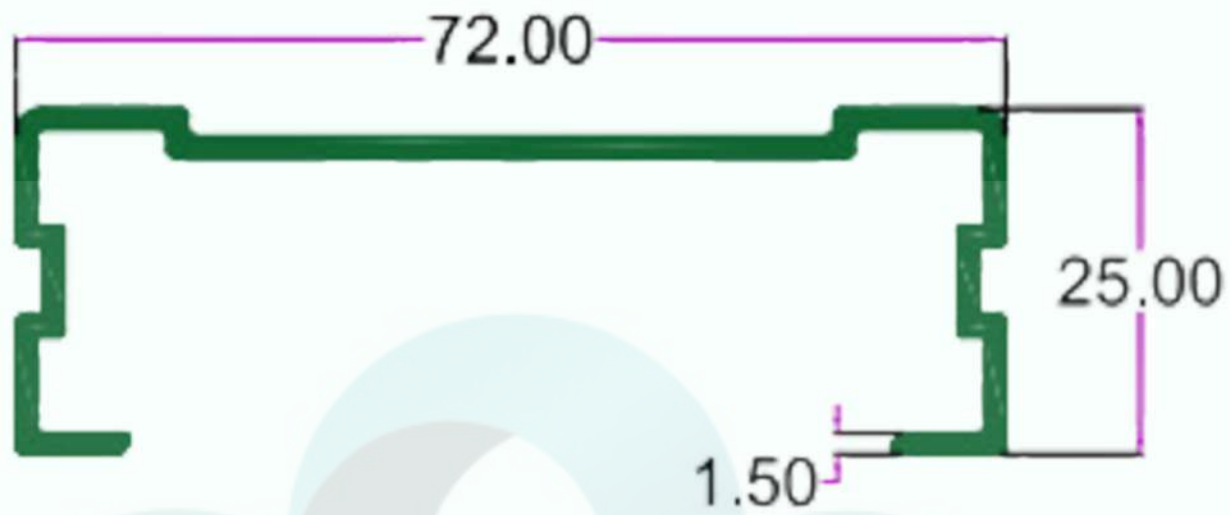

SEC.NO. 5090
WT. 2.110 TO 2.350 KG/12'

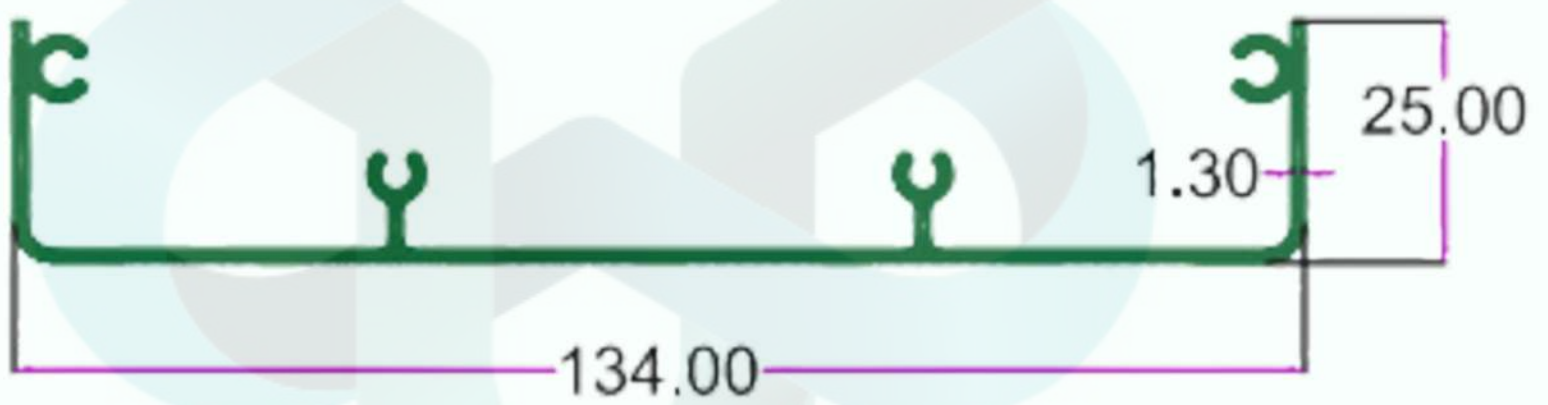

SEC. NO. 3441
WT. 2.850 TO 3.150 KG/12'

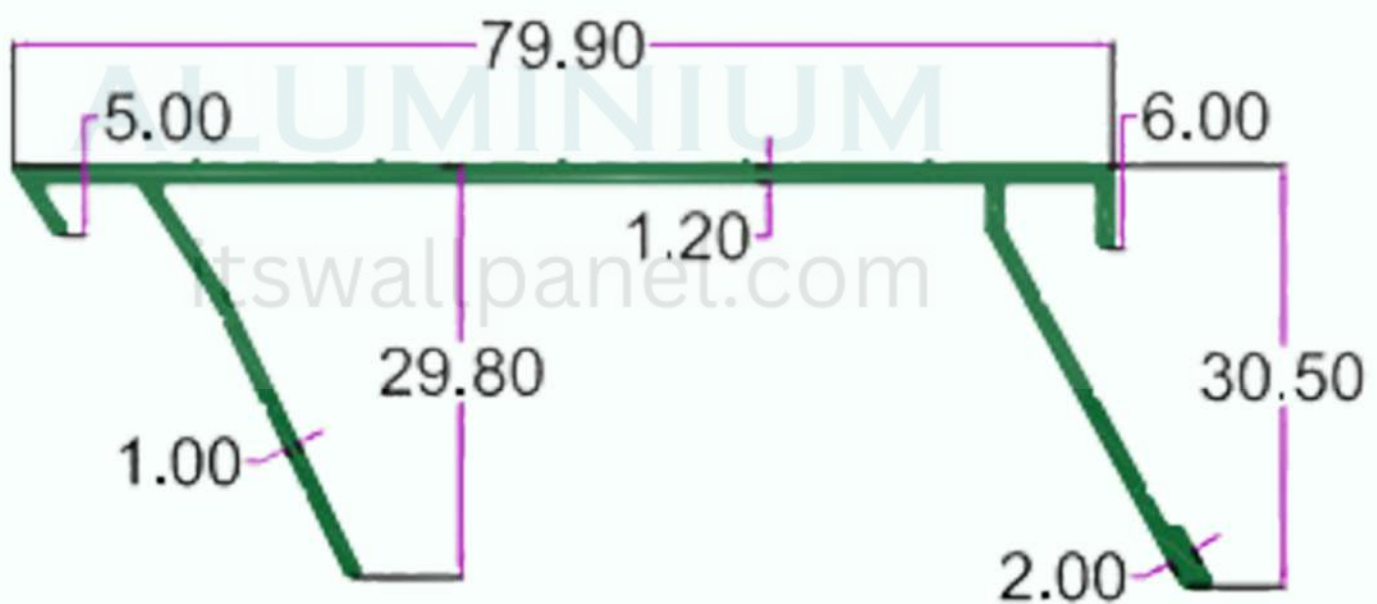

SEC.NO. 4505
WT. 1.700 TO 2.000 KG/12'

LADDER SECTION



INTELLIGENT
ALUMINIUM
itswallpanel.com

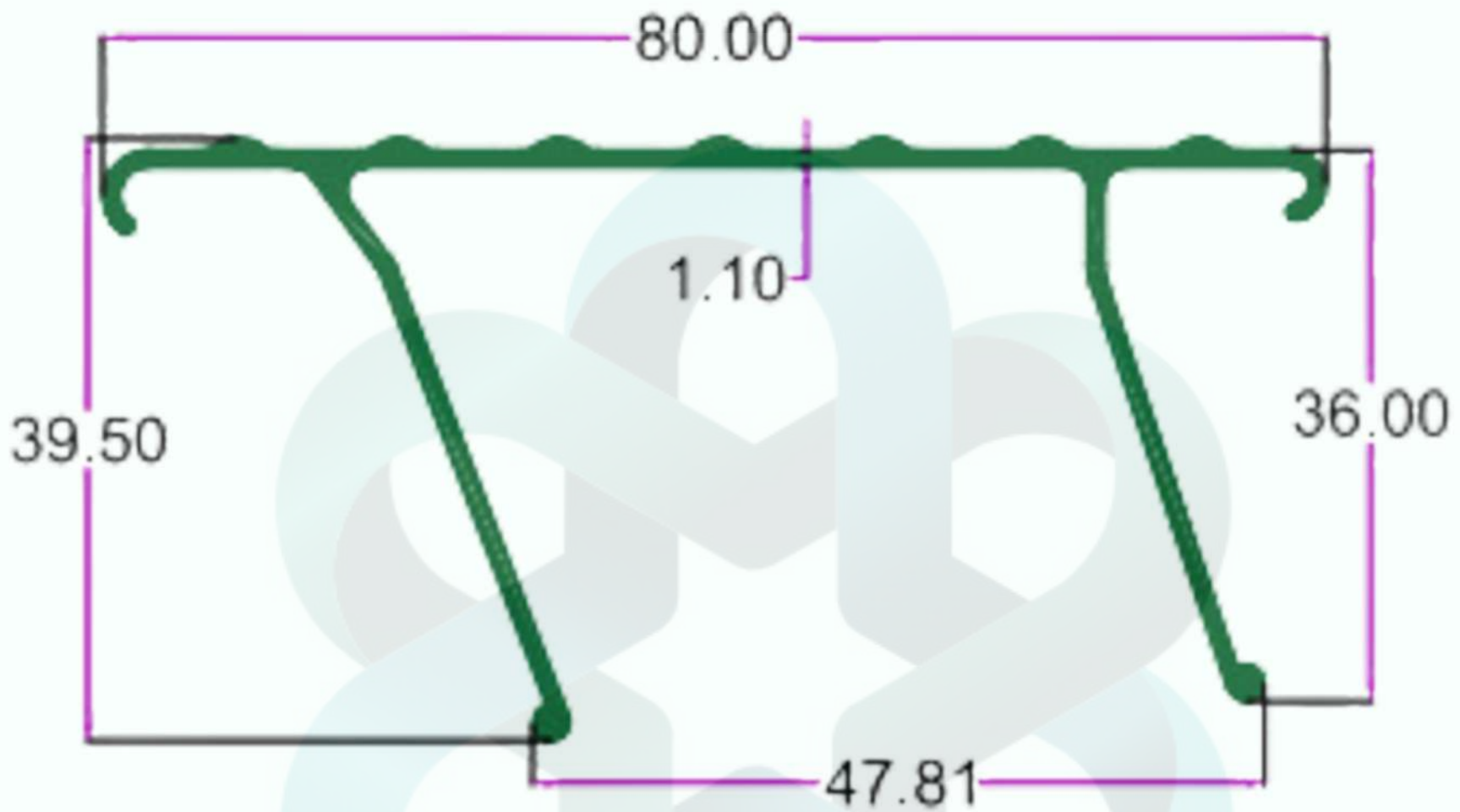

SEC. NO. 4000
WT. 2.000 TO 2.400 KG/12'

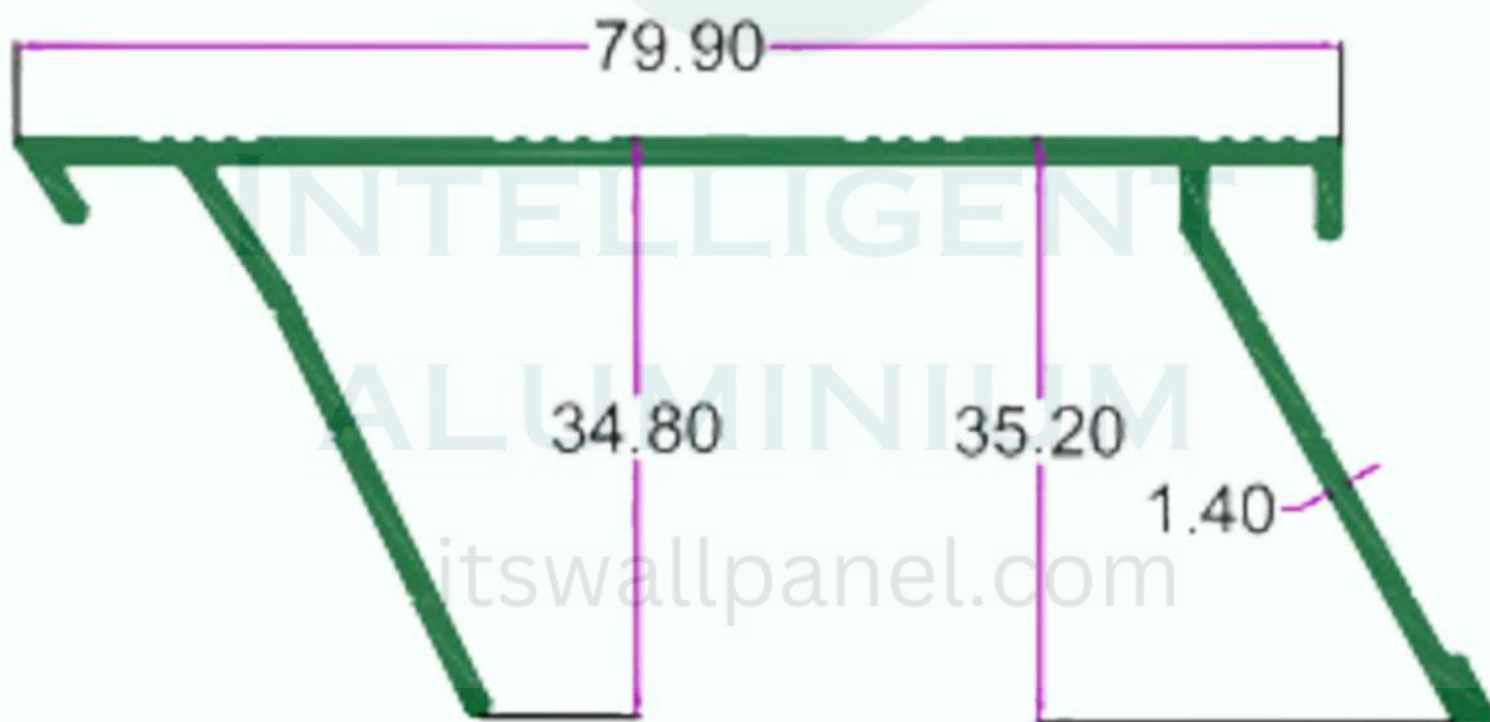

SEC. NO. 4051
WT. 2.300 TO 2.550 KG/12'

LADDER SECTION



INTELLIGENT
ALUMINIUM
itswallpanel.com

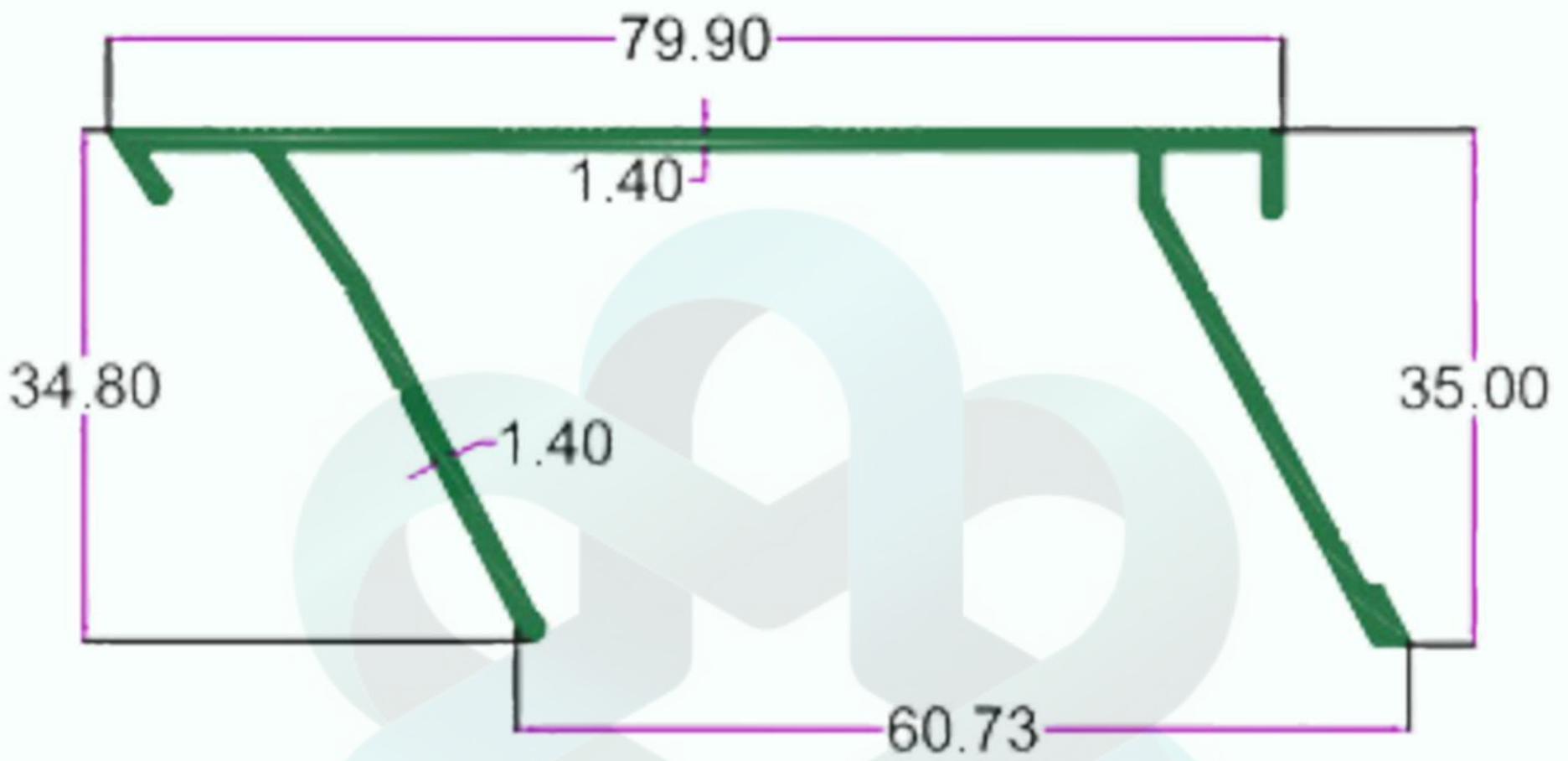

SEC. NO. 4078
WT. 2.200 TO 2.300 KG/12'

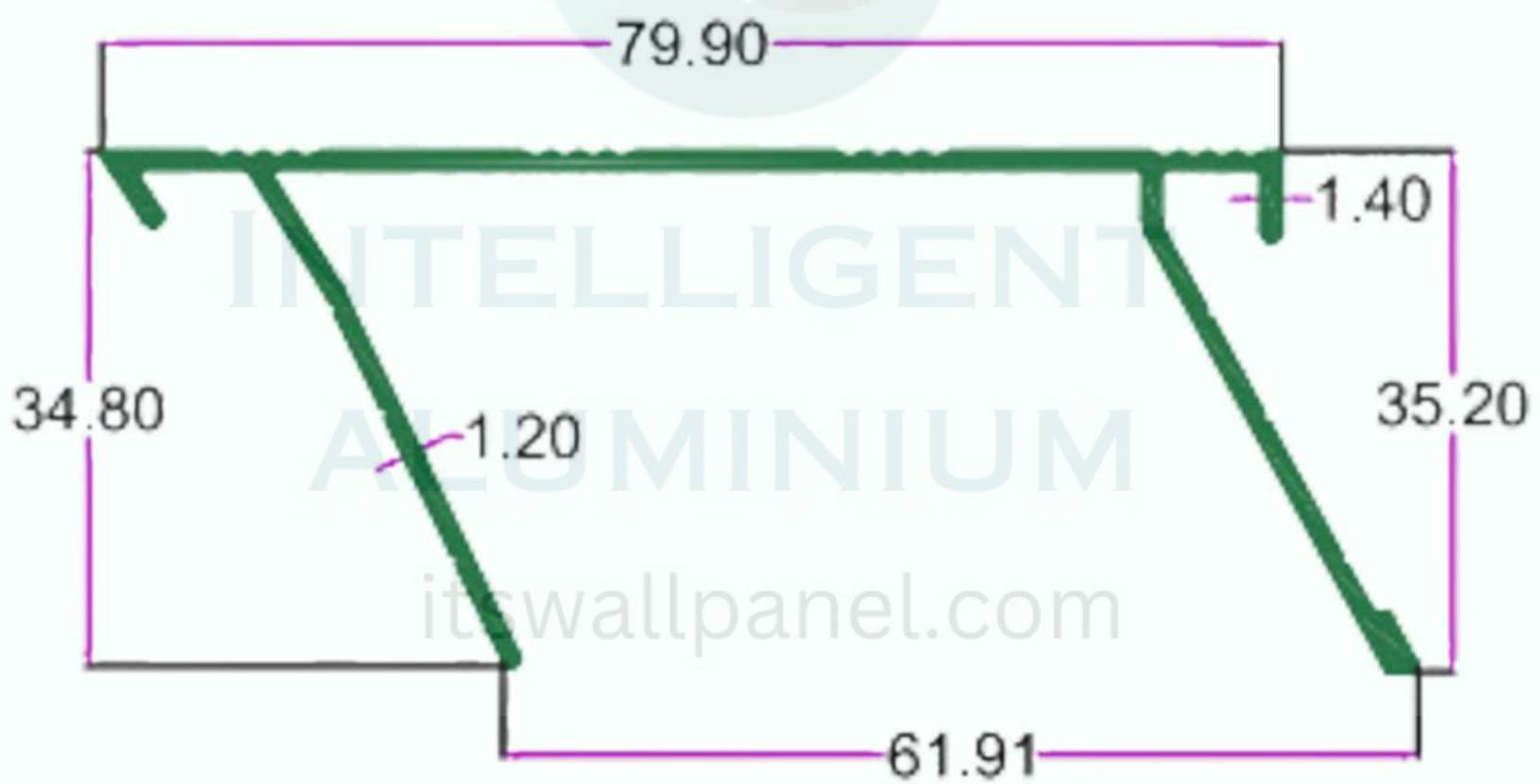

SEC. NO. 4182
WT. 1.940 TO 2.200 KG/12'

LADDER SECTION



INTELLIGENT
ALUMINIUM
itswallpanel.com

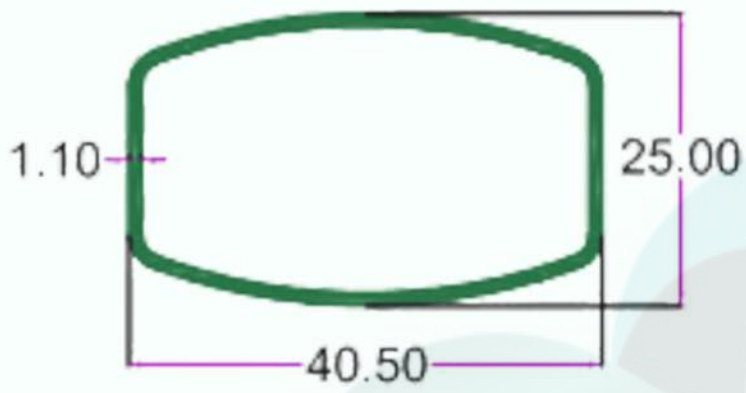

SEC. NO. 4001
WT. 1.200 TO 1.550 KG/12'

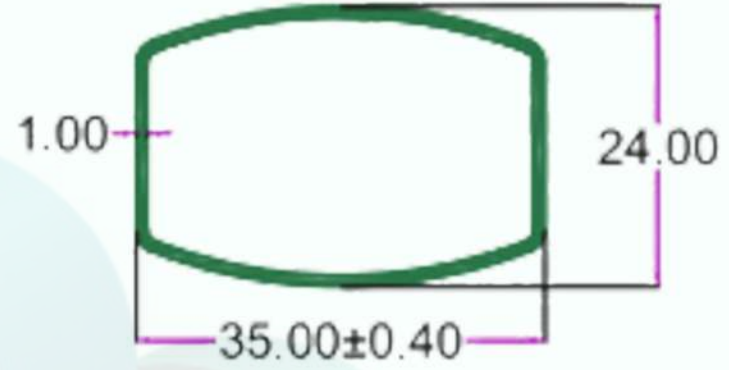

SEC. NO. 4002
WT. 1.000 TO 1.350 KG/12'

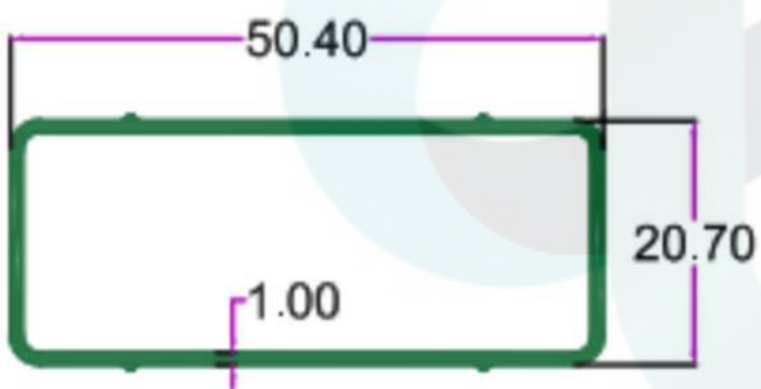

SEC. NO. 4049
WT. 1.340 TO 1.500 KG/12'

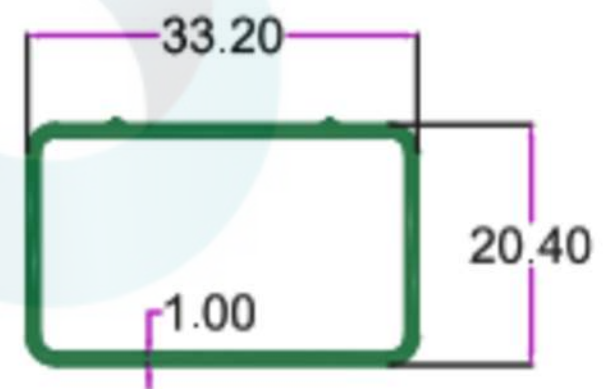

SEC. NO. 4050
WT. 0.990 TO 1.200 KG/12'

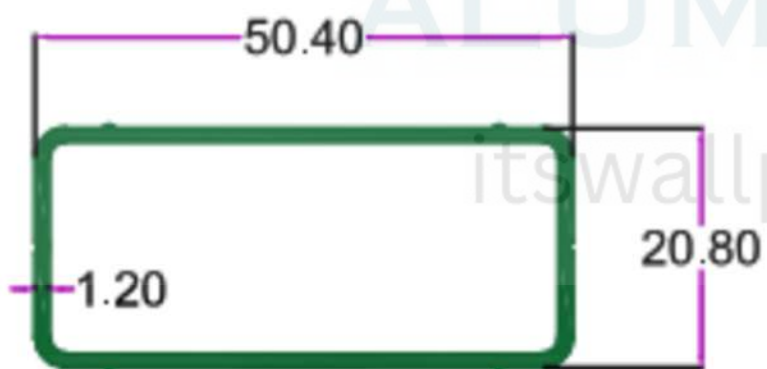

SEC. NO. 4076
WT. 1.550 TO 1.650 KG/12'

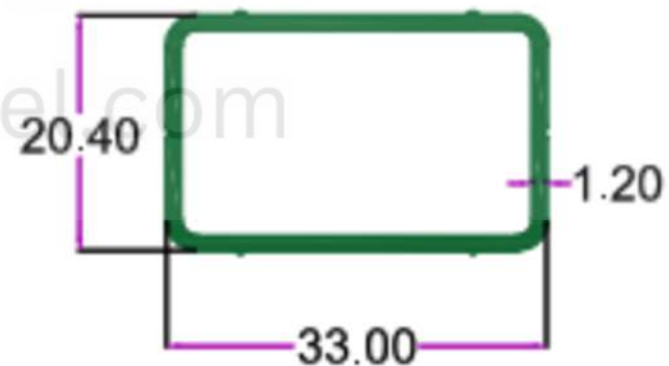

SEC. NO. 4075
WT. 1.150 TO 1.220 KG/12'

LADDER SECTION



INTELLIGENT
ALUMINIUM
itswallpanel.com

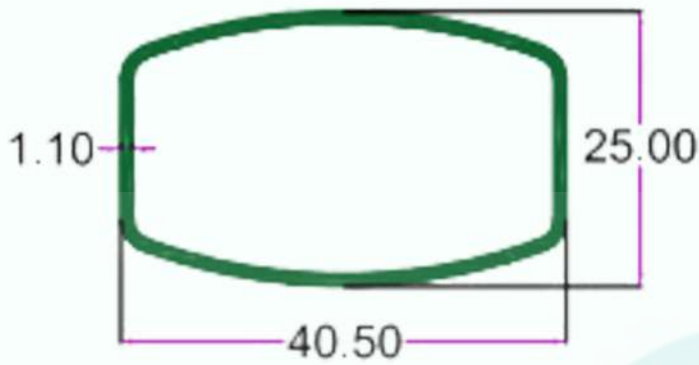

SEC. NO. 4001
WT. 1.200 TO 1.550 KG/12'

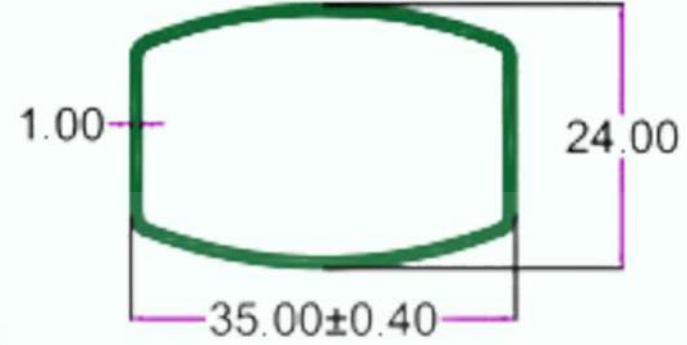

SEC. NO. 4002
WT. 1.000 TO 1.350 KG/12'

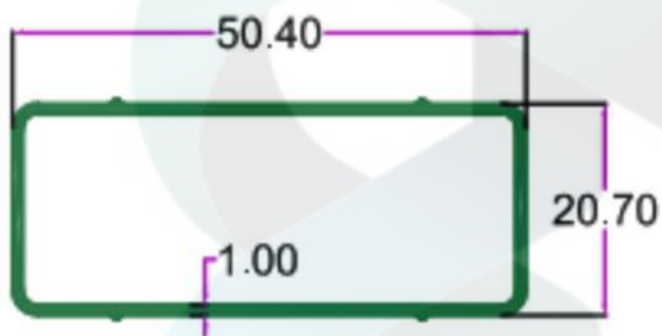

SEC. NO. 4049
WT. 1.340 TO 1.500 KG/12'

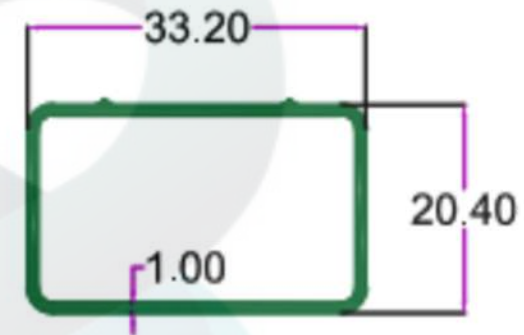

SEC. NO. 4050
WT. 0.990 TO 1.200 KG/12'

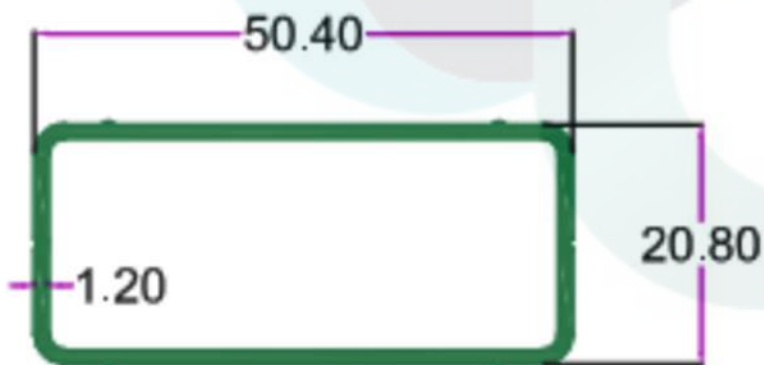

SEC. NO. 4076
WT. 1.550 TO 1.650 KG/12'

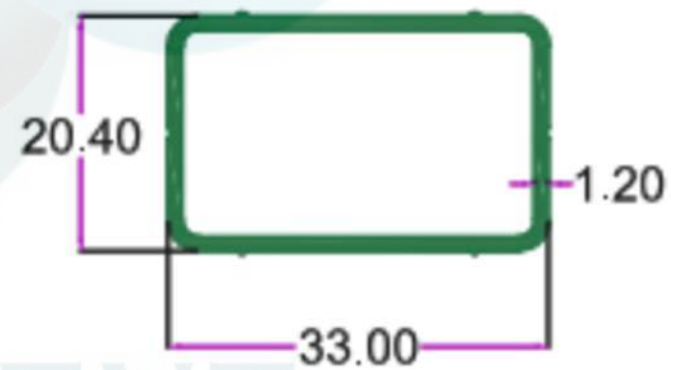

SEC. NO. 4075
WT. 1.150 TO 1.220 KG/12'

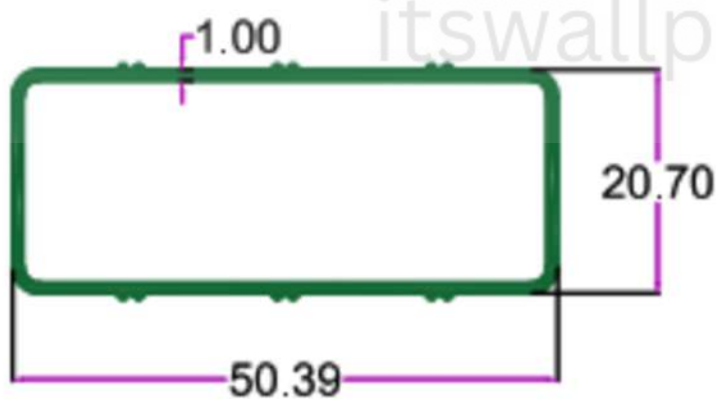

SEC. NO. 4089
WT. 1.370 TO 1.500 KG/12'

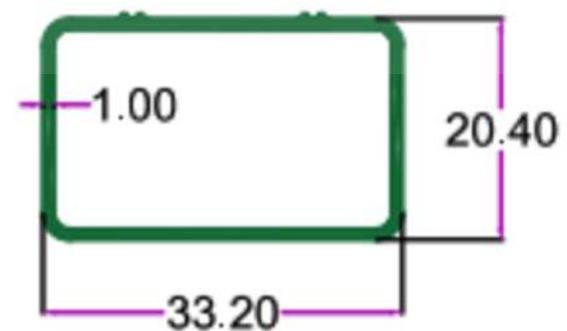

SEC. NO. 4090
WT. 1.000 TO 1.150 KG/12'

LADDER SECTION FLUTED ROUND TUBE



INTELLIGENT
ALUMINIUM
itswallpanel.com

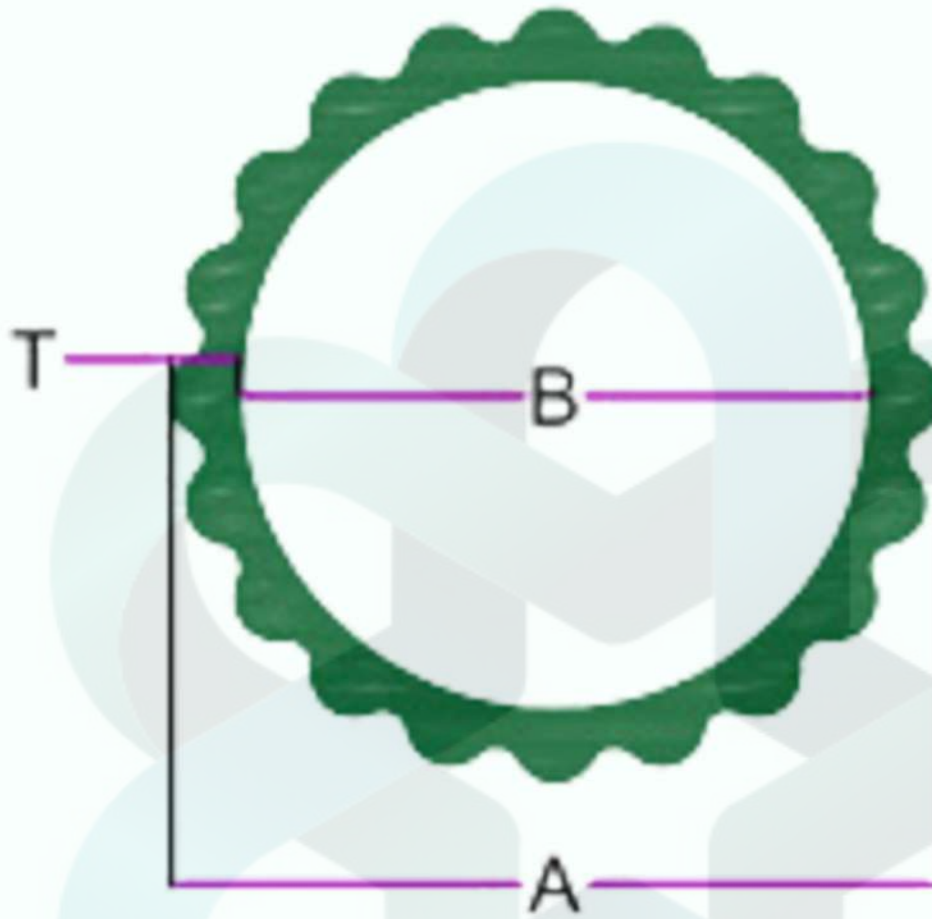

FLUTED ROUND TUBE

S.No.	Section No.	A in mm.	B in mm.	T in mm.	Weight (KG/12')
1	1411	13.50	11.00	1.25	0.700-1.000
2	1417	13.50	8.50	2.50	0.750-0.850
3	1410	17.00	15.00	1.00	0.500-0.600
4	1409	20.00	16.40	1.80	0.950-1.100
5	1412	22.50	19.50	1.50	0.700-1.000
6	1419	25.00	20.20	2.40	1.500-1.700
7	1420	27.50	25.00	1.25	1.000-1.200
8	1413	28.00	25.50	1.25	0.750-0.850
9	1421	88.00	82.00	3.00	7.500-7.900
10	1422	100.00	90.00	5.00	14.10-14.500
11	1423	125.00	120.00	2.50	9.000-9.400

LADDER SECTION FLUTED ROUND TUBE



INTELLIGENT
ALUMINIUM
itswallpanel.com

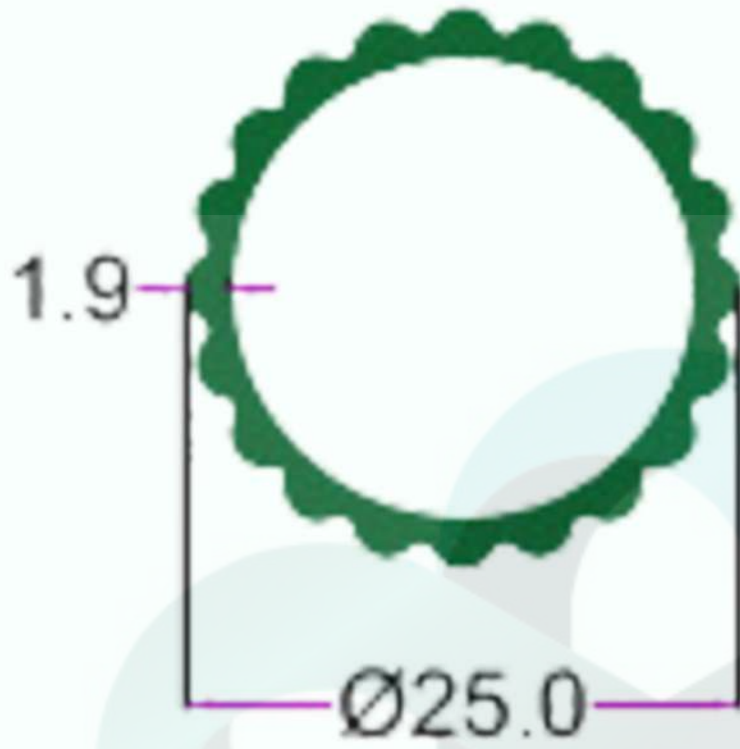

SEC. NO. 1401

WT. 1.100 TO 1.300 KG/12'

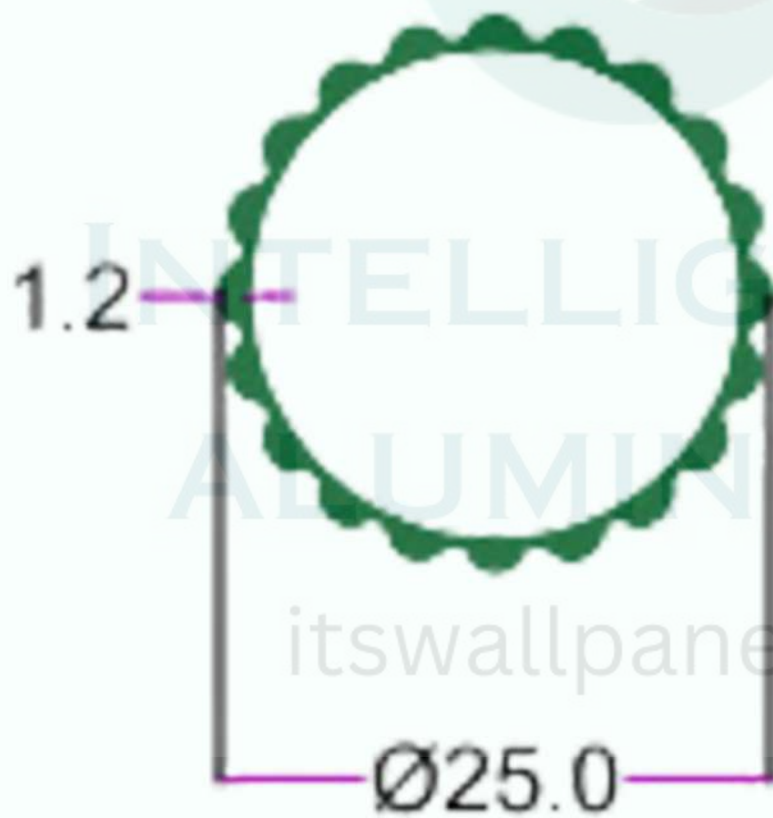

SEC. NO. 1404

WT. 0.480 TO 0.550 KG/12'

LADDER SECTION FLUTED ROUND TUBE



INTELLIGENT
ALUMINIUM
itswallpanel.com

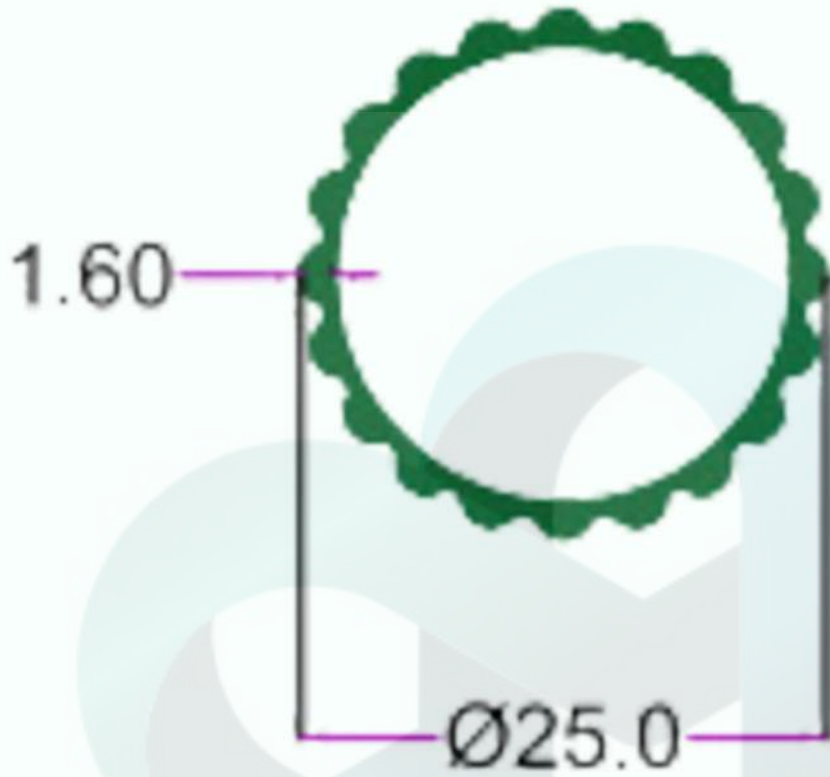

SEC. NO. 1402

WT. 0.850 TO 1.000 KG/12'

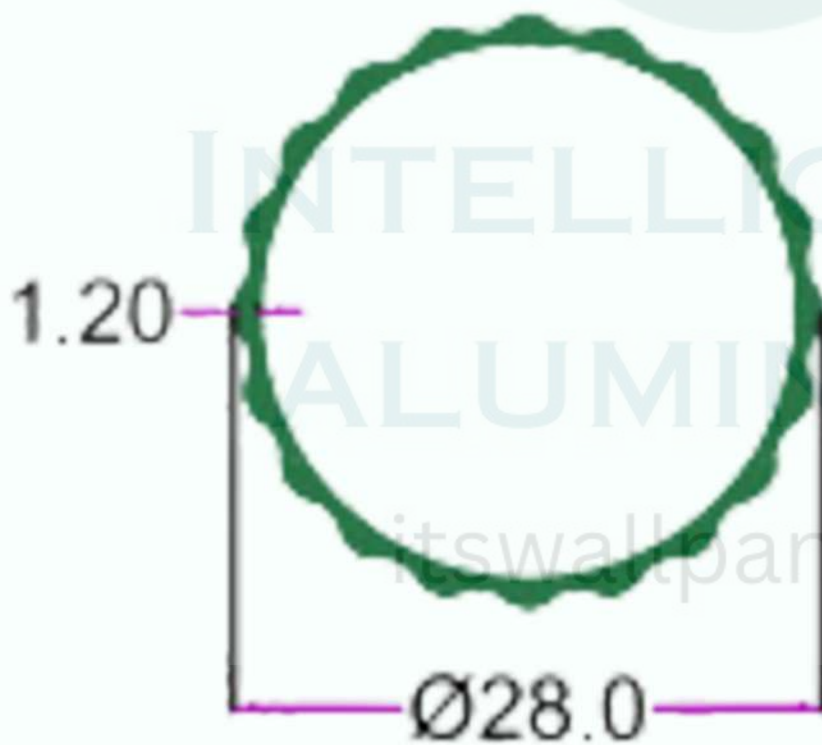

SEC. NO. 1405

WT. 0.800 TO 1.000 KG/15'

LADDER SECTION FLUTED ROUND TUBE



INTELLIGENT
ALUMINIUM
itswallpanel.com

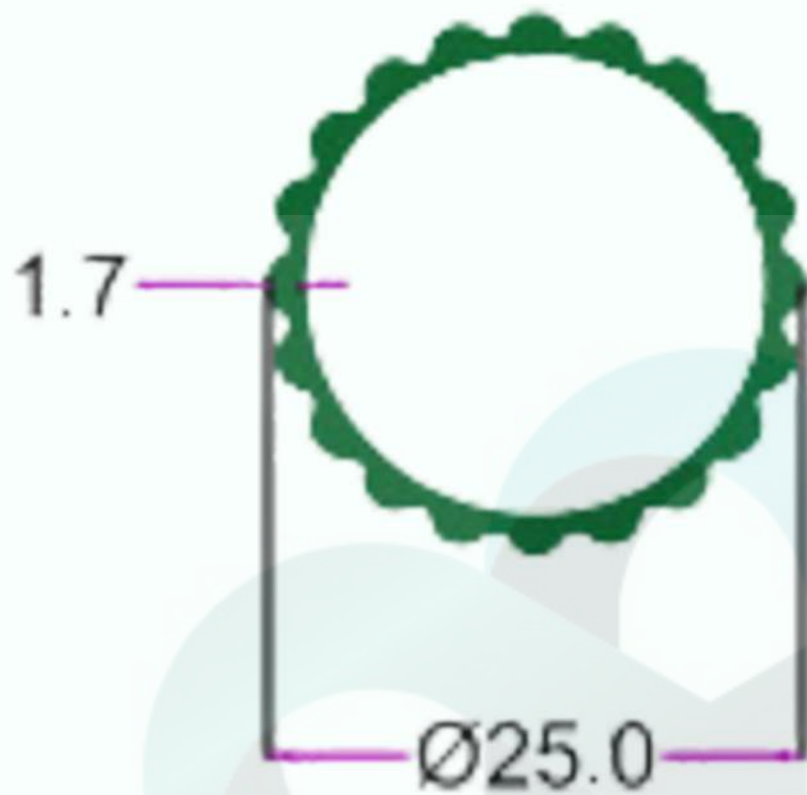

SEC. NO. 1403

WT. 1.050 TO 1.250 KG/12'

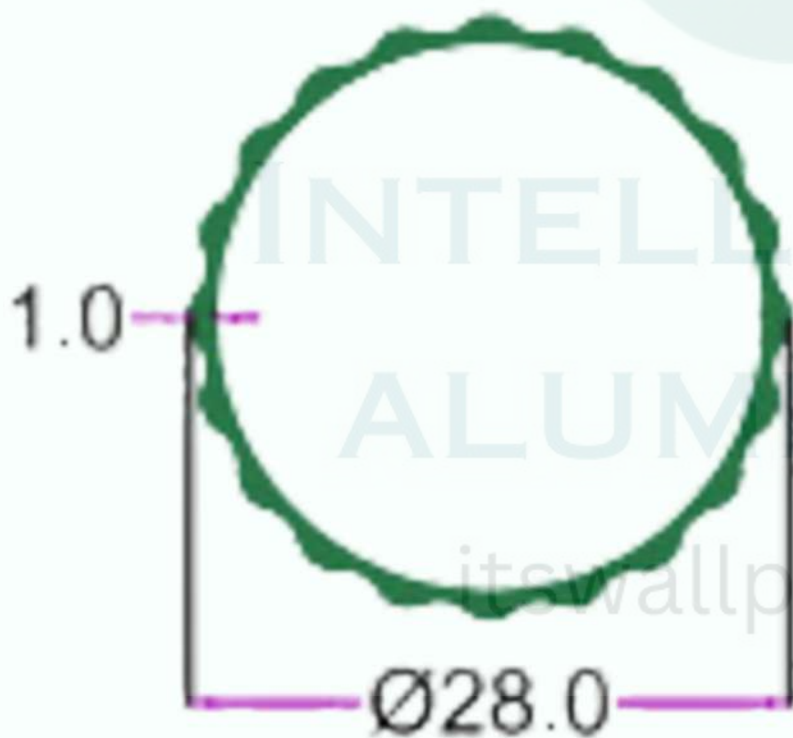

SEC. NO. 1406

WT. 0.650 TO 0.750 KG/15'

LADDER SECTION FLUTED ROUND TUBE



INTELLIGENT
ALUMINIUM
itswallpanel.com

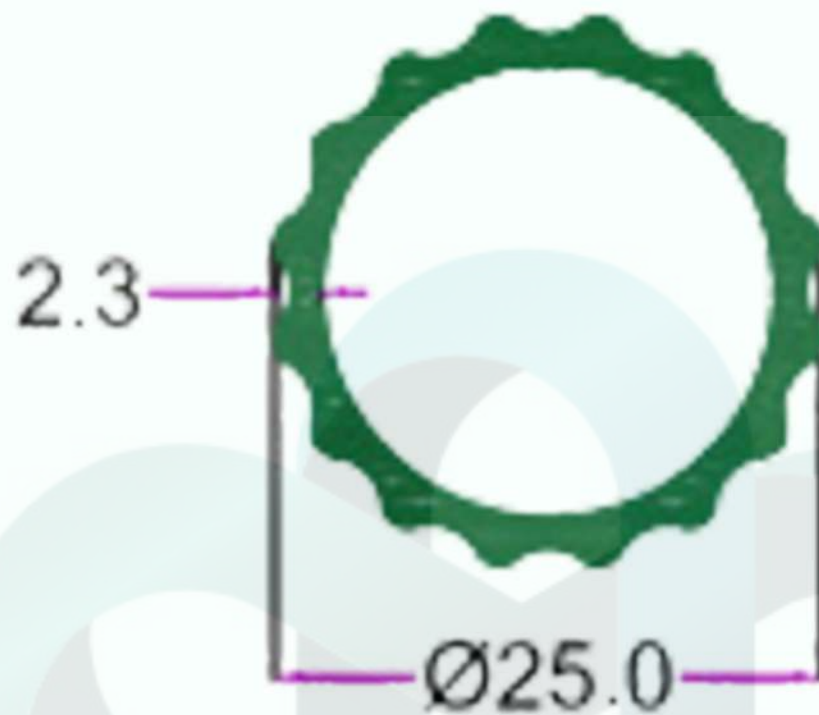

SEC. NO. 1407

WT. 1.000 TO 1.500 KG/12'



SEC. NO. 1415

WT. 0.545 TO 0.750 KG/12'



INTELLIGENT
ALUMINIUM
itswallpanel.com

LADDER SECTION FLUTED ROUND TUBE

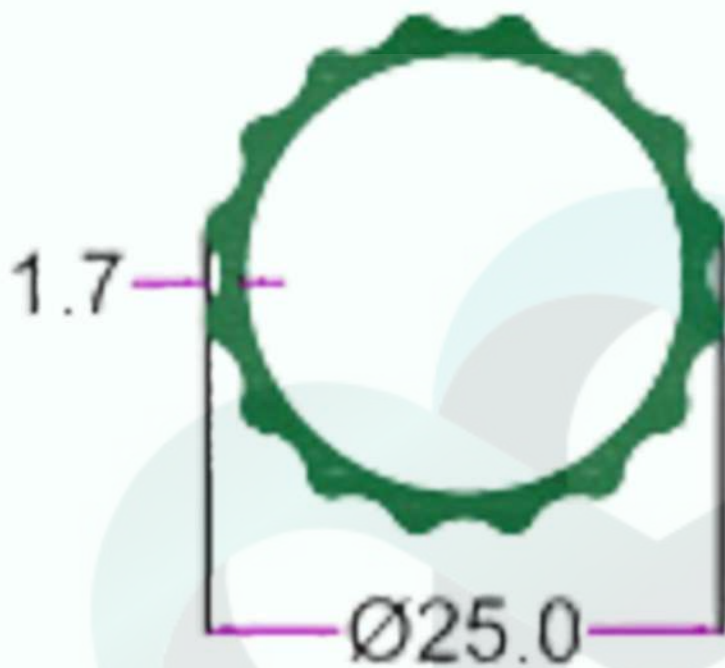

SEC. NO. 1408

WT. 0.900 TO 1.200 KG/12'



SEC. NO. 4619

WT. 0.900 TO 1.000 KG/12'

LADDER SECTION FLUTED ROUND TUBE



INTELLIGENT
ALUMINIUM
itswallpanel.com

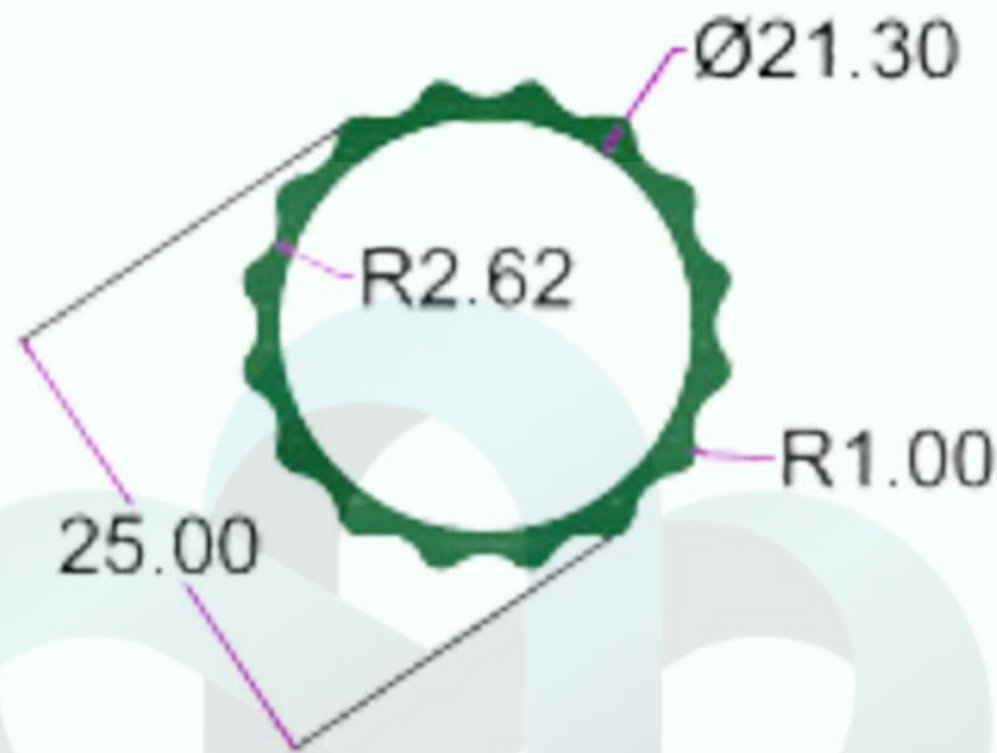

SEC. NO. 4521

WT. 0.870 TO 0.950 KG/12'

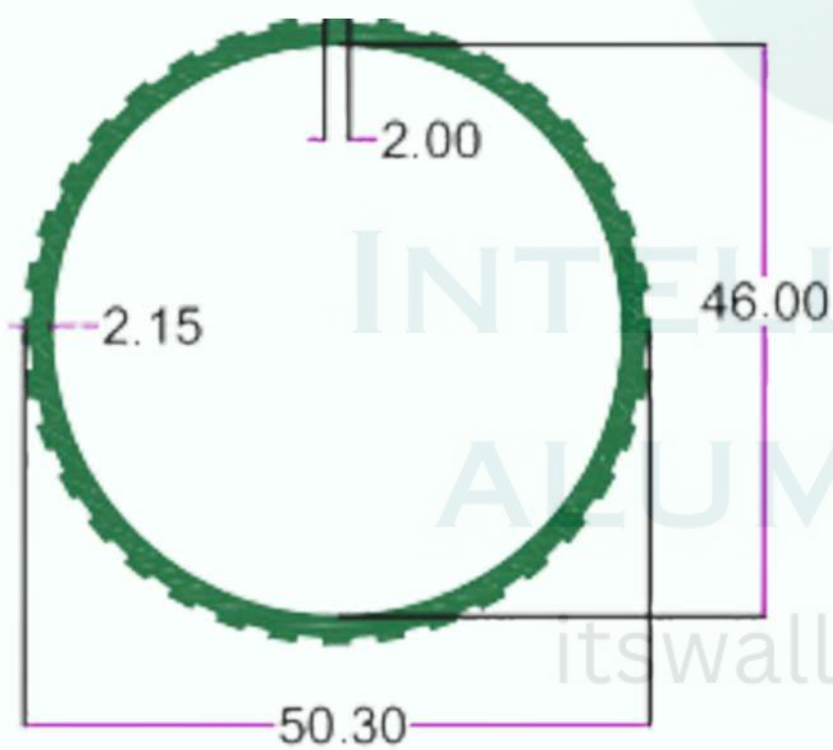

SEC. NO. 1416

WT. 2.7000 TO 3.000 KG/12'



SEC. NO. 1414

WT. 1.500 TO 1.600 KG/12'

LADDER SECTION FLUTED ROUND TUBE



INTELLIGENT
ALUMINIUM
itswallpanel.com



SEC. NO. 1451

WT. 1.313 TO 1.613 KG/15'

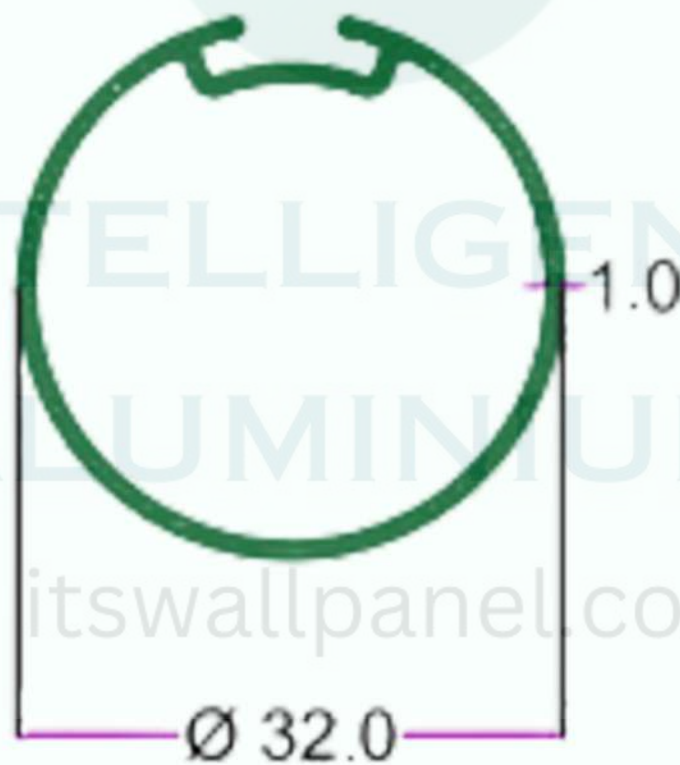

SEC. NO. 1454

WT. 1.300 TO 1.500 KG/12'

LADDER SECTION FLUTED ROUND TUBE



INTELLIGENT
ALUMINIUM
itswallpanel.com



SEC. NO. 1452
WT. 1.615 TO 1.915 KG/15'



SEC. NO. 1455
(L) WT. 1.200 TO 1.350 KG/15'
(H) WT. 1.370 TO 1.550 KG/15'

LADDER SECTION FLUTED ROUND TUBE



INTELLIGENT
ALUMINIUM
itswallpanel.com

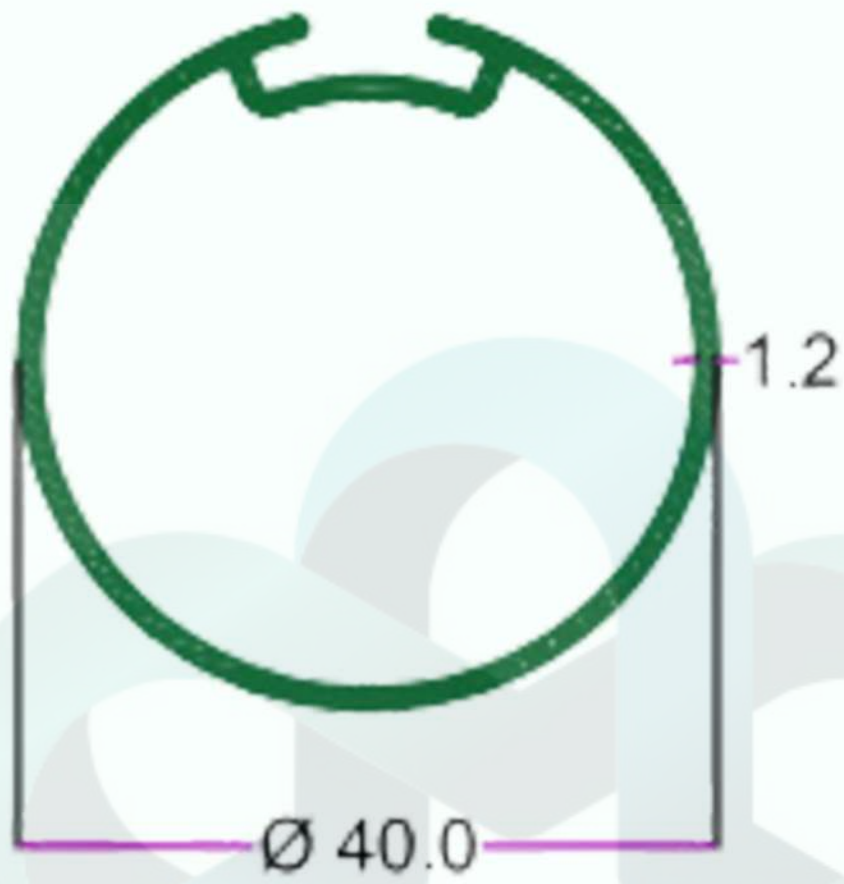

SEC. NO. 1453
WT. 1.700 TO 1.900 KG/12'

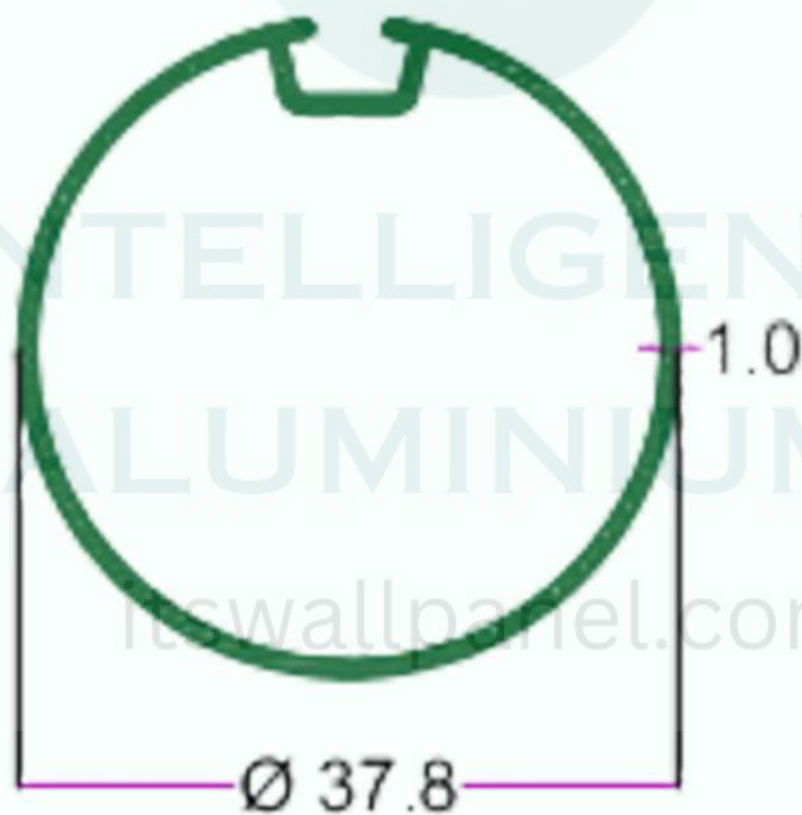

SEC. NO. 1456
WT. 1.245 TO 1.400 KG/12'

LADDER SECTION FLUTED ROUND TUBE



INTELLIGENT
ALUMINIUM
itswallpanel.com

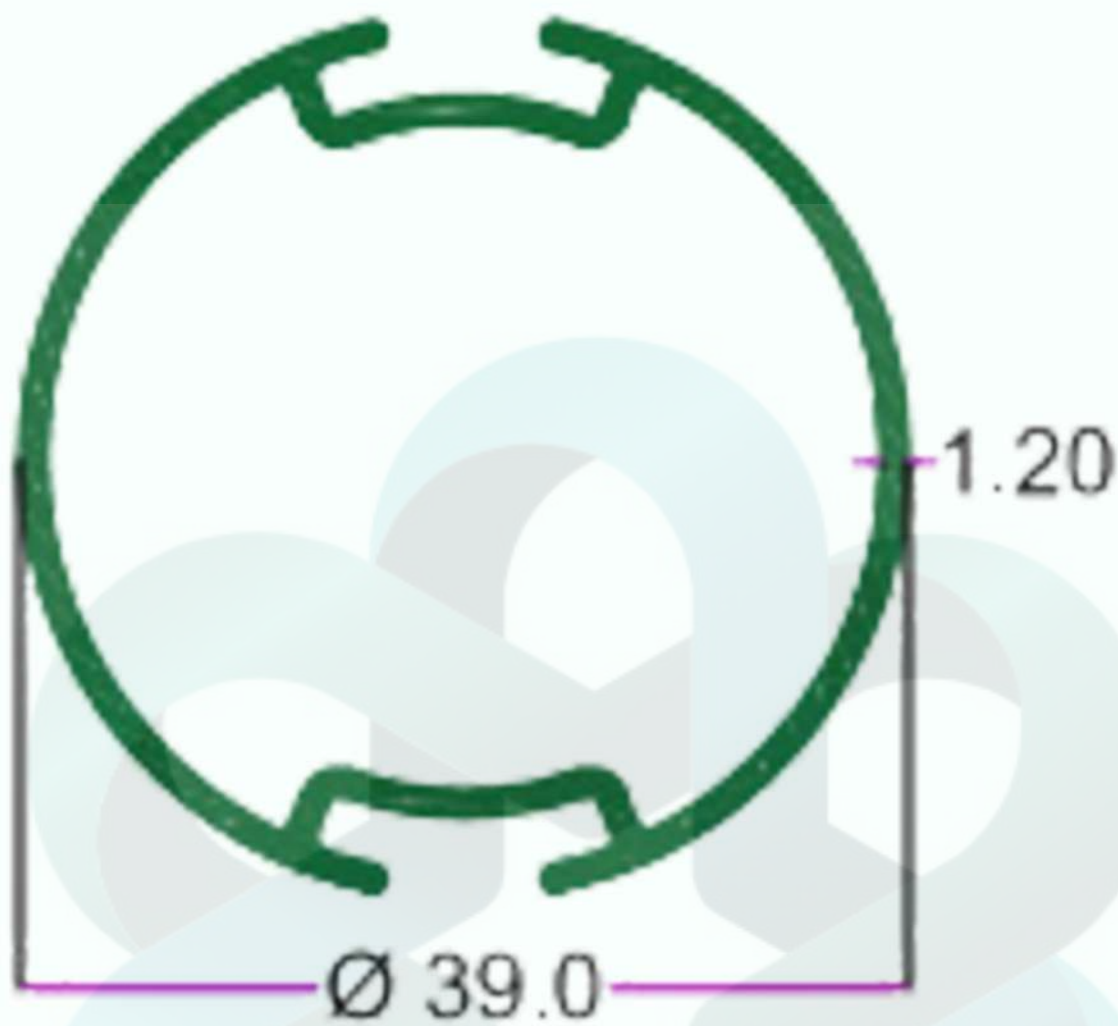

SEC. NO. 1457

WT. 1.300 TO 1.500 KG/12'



SEC. NO. 1460

WT. 0.930 TO 1.100 KG/12'



INTELLIGENT
ALUMINIUM
itswallpanel.com

LADDER SECTION FLUTED ROUND TUBE

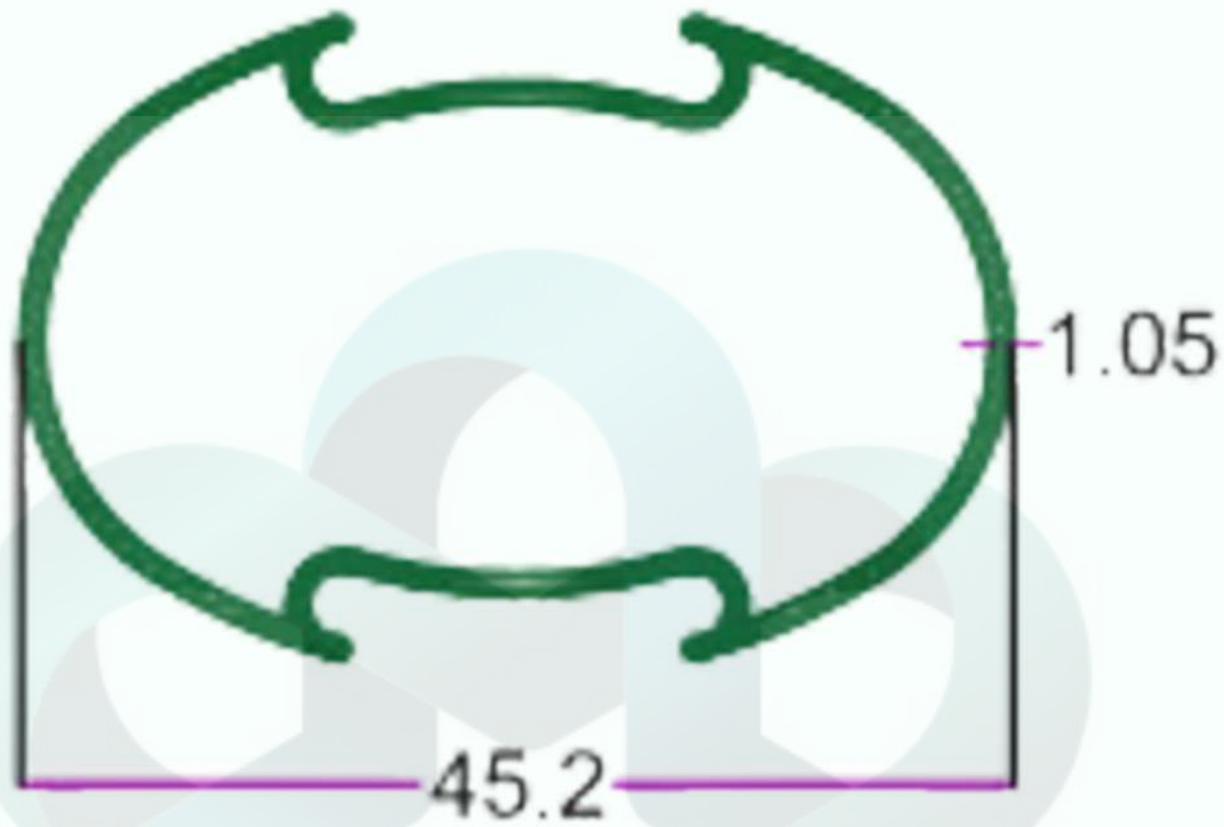

SEC. NO. 1458

WT. 1.200 TO 1.500 KG/12'



SEC. NO. 1461

WT. 0.990 TO 1.200 KG/12'

LADDER SECTION



INTELLIGENT
ALUMINIUM
itswallpanel.com



SEC. NO. 1459

WT. 0.900 TO 1.100 KG/15'

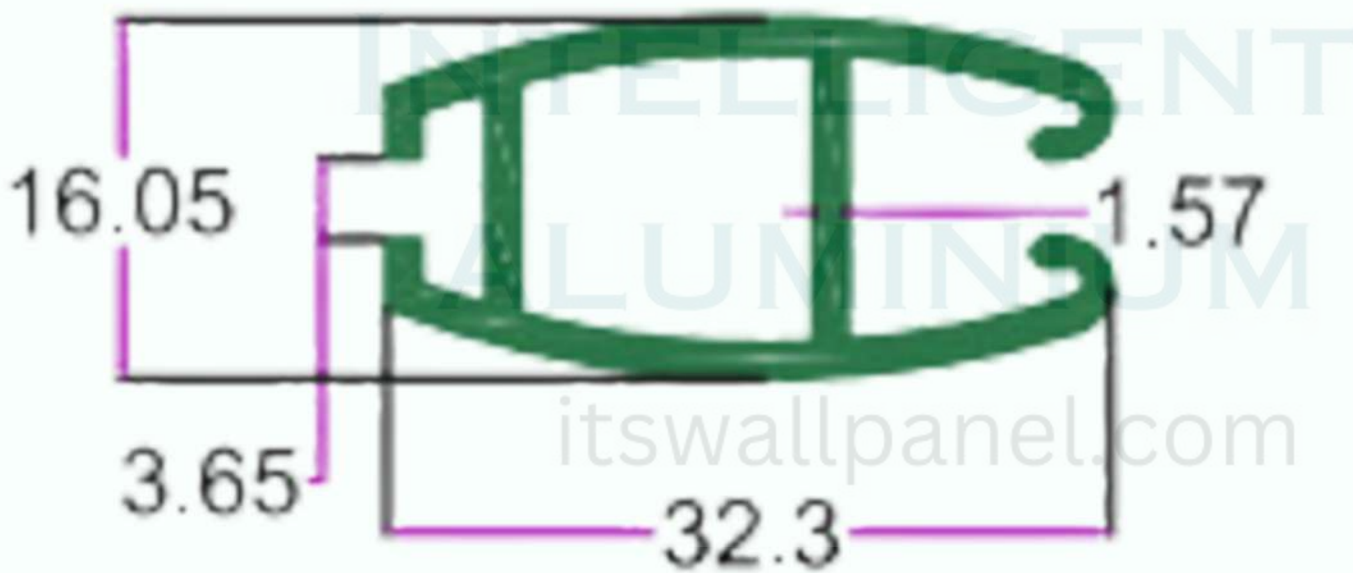

SEC. NO. 1462

WT. 1.557 TO 1.700 KG/12'

LADDER SECTION



INTELLIGENT
ALUMINIUM
itswallpanel.com



SEC. NO. 1463

WT. 0.950 TO 1.100 KG/15'

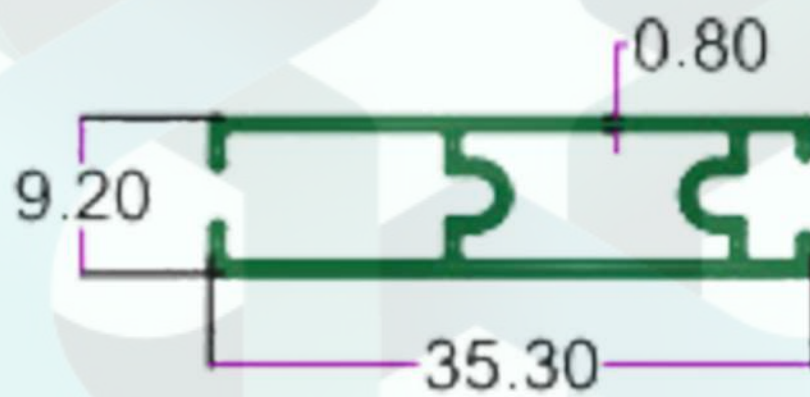

SEC. NO. 3840

WT. 1.050 TO 1.200 KG/15'

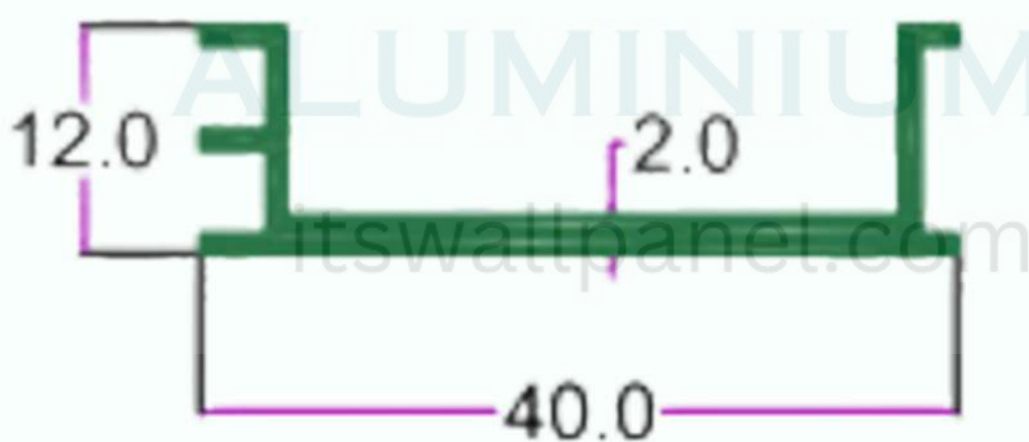

SEC. NO. 2846

WT. 1.300 TO 1.450 KG/15'

LADDER SECTION



INTELLIGENT
ALUMINIUM

itswallpanel.com

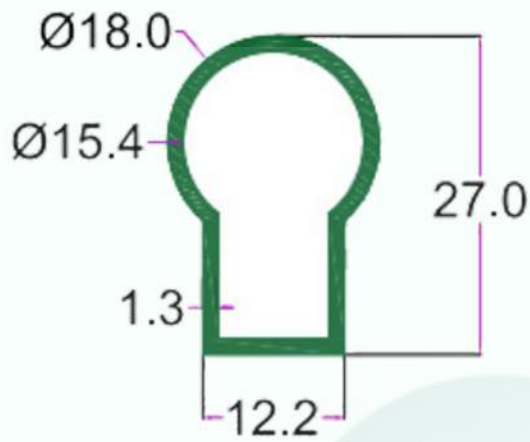

SEC. NO. 3183
WT. 0.900 TO 1.000 KG/12'

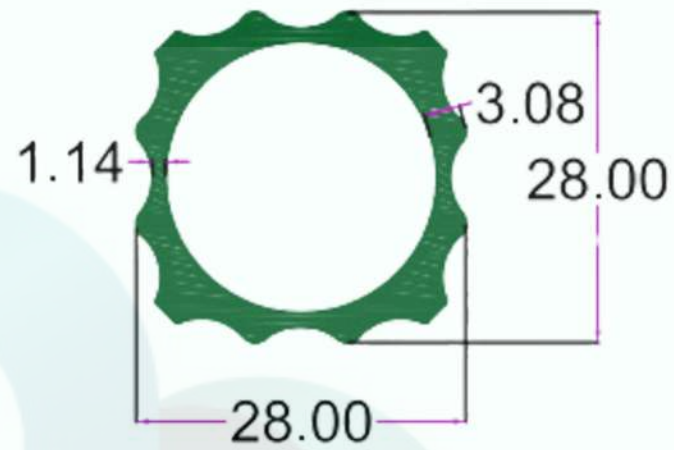

SEC. NO. 5091
WT. 2.220 TO 2.470 KG/12'

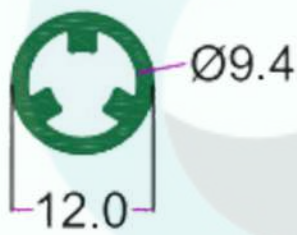

SEC. NO. 3181
WT. 0.530 TO 0.586 KG/12'



SEC. NO. 3182
WT. 0.677 TO 0.750 KG/12'



SEC. NO. 4522
WT. 1.820 TO 2.050 KG/12'

LADDER SECTION



INTELLIGENT
ALUMINIUM
itswallpanel.com

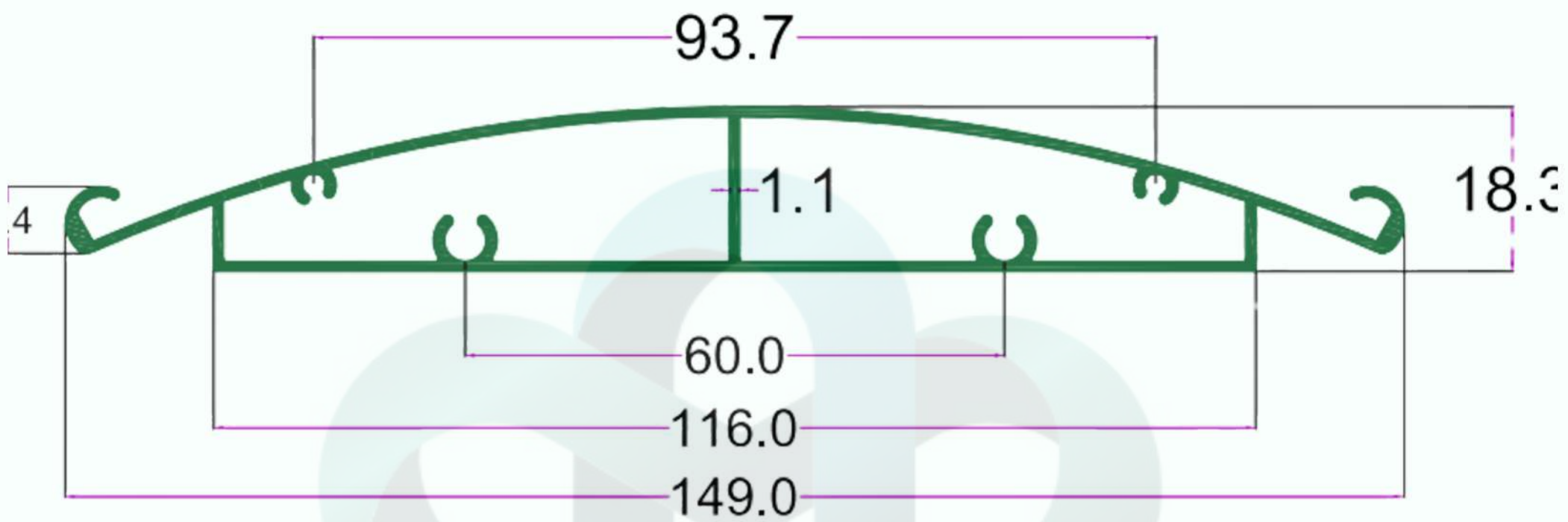

SEC. NO. 1466
WT. 3.929 TO 4.100 KG/12'

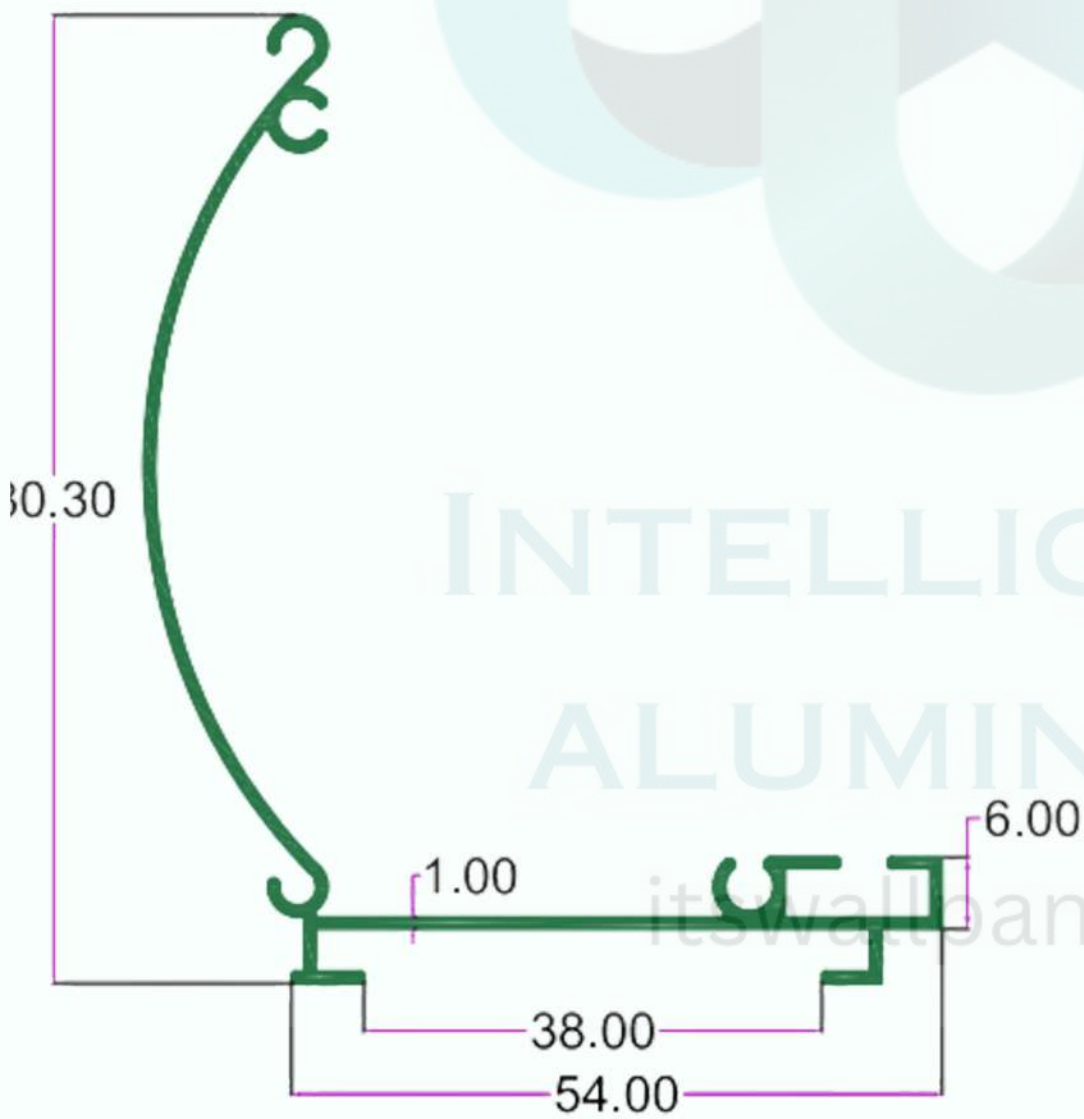

SEC. NO. 1465
WT. 2.140 TO 2.300 KG/12'

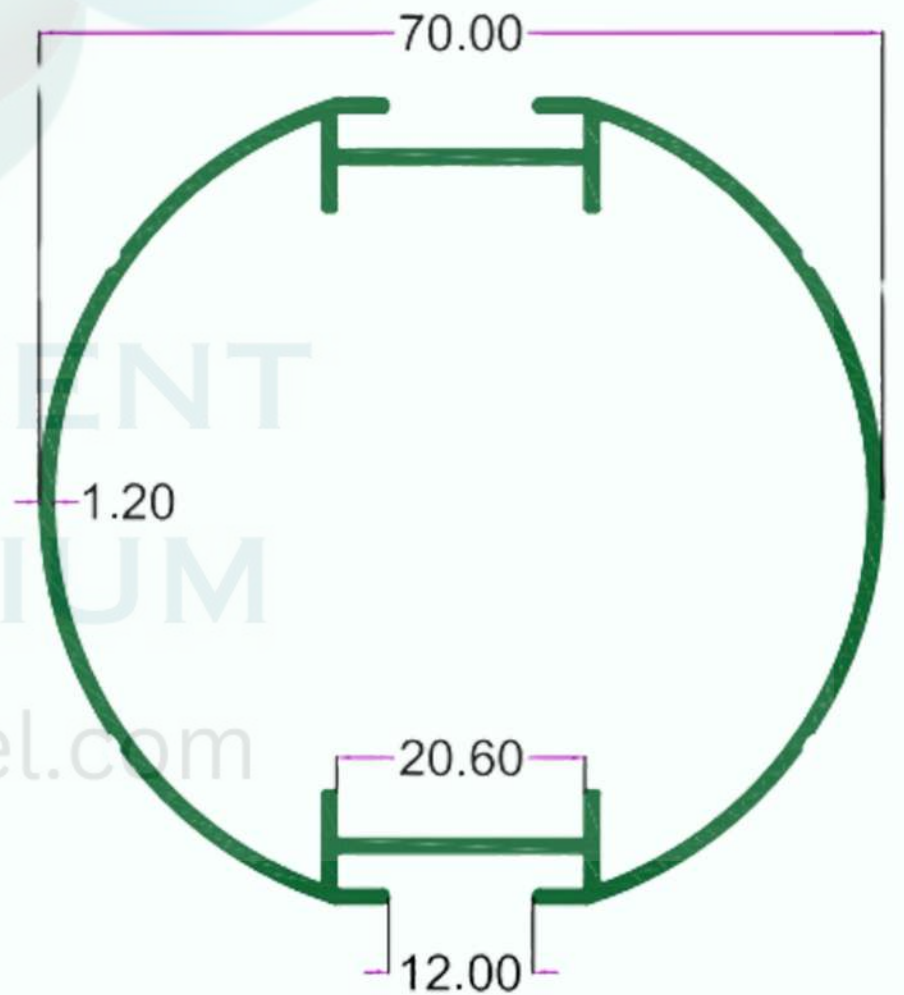

SEC. NO. 4177
WT. 3.100 TO 3.300 KG/12'