

SLIDING SECTION BOMBAY SLIDING

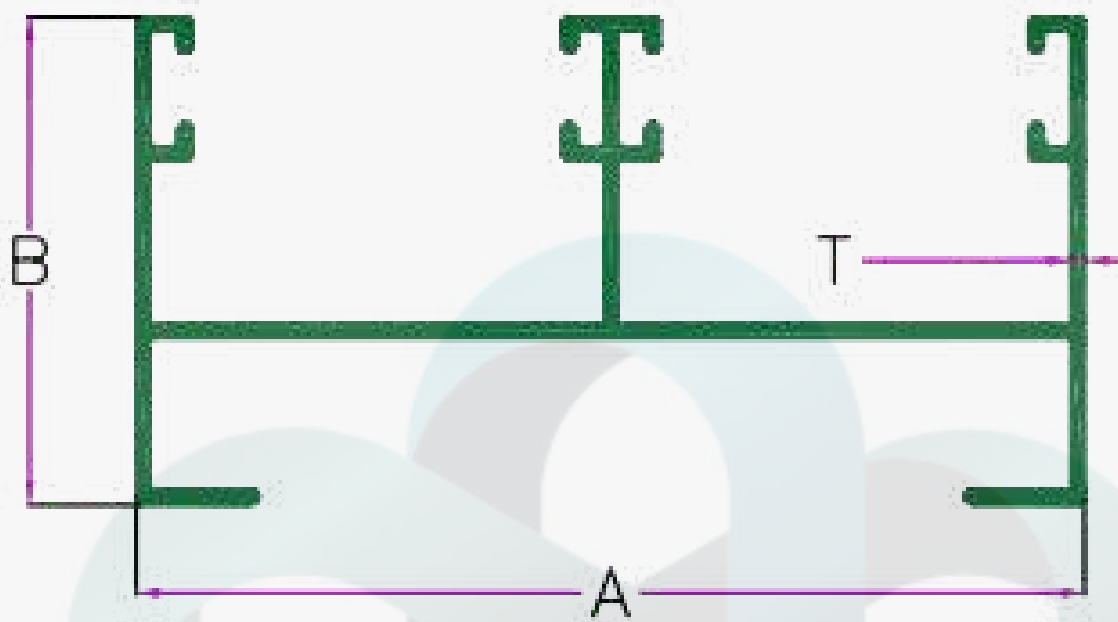

INTELLIGENT
ALUMINIUM
itswallpanel.com



3/4" 2 TRACK TOP

S. No.	Sec No.	A in mm.	B in mm.	T in mm.	Wt. (KG/12')
1	1861	62	32	1.00	1.800-2.000
2	1862	62	32	1.35	2.100-2.300
3	1863	62	32	1.60	2.400-2.700
4	1864	62	32	1.80	2.800-3.200

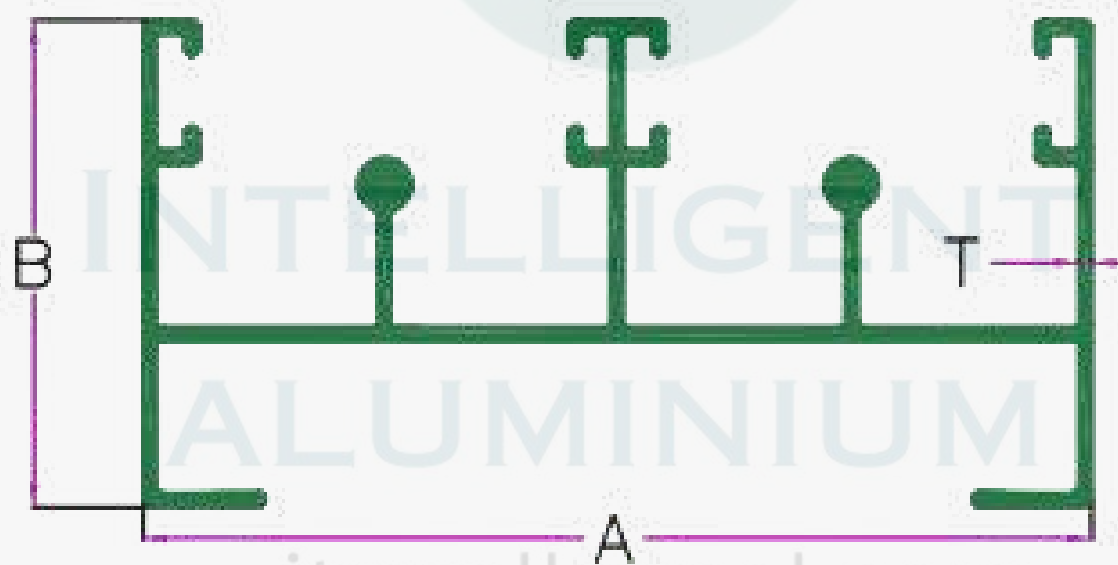

3/4" 2 TRACK BOTTOM

S. No.	Section No.	A in mm.	B in mm.	T in mm.	Weight (KG/12')
1	1871	62	32	0.90	1.800-2.000
2	1872	62	32	1.20	2.100-2.300
3	1873	62	32	1.50	2.400-2.700
4	1874	62	32	1.80	2.800-3.200

SLIDING SECTION BOMBAY SLIDING



INTELLIGENT
ALUMINIUM
itswallpanel.com

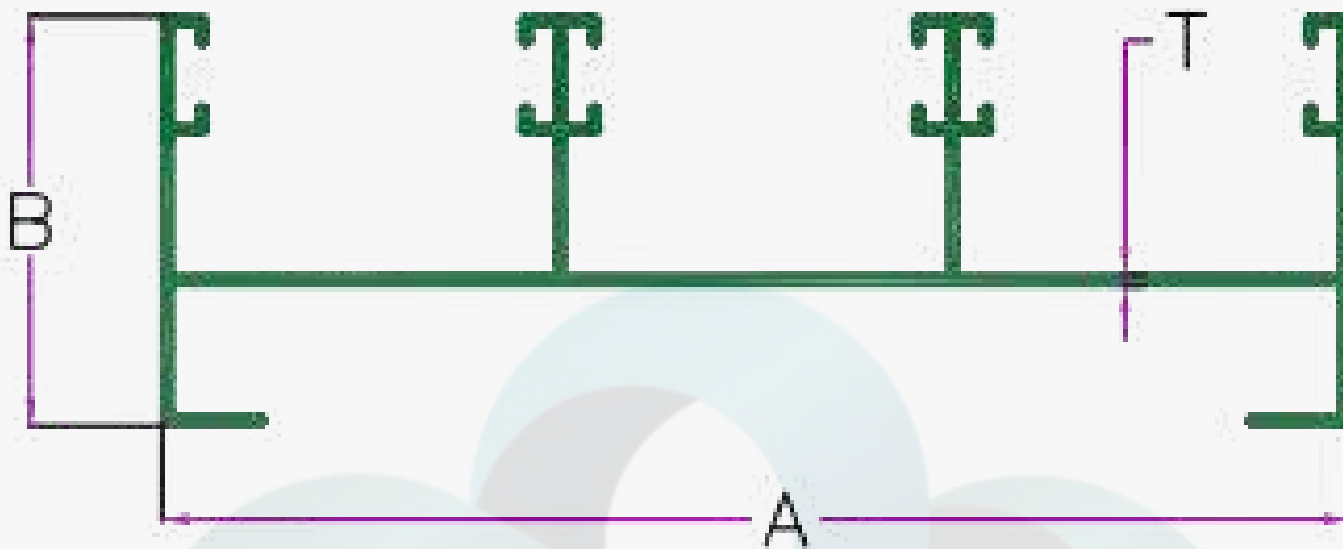

3/4" 3 TRACK TOP

Sl No.	Section No.	A in mm.	B in mm.	T in mm.	Weight (KG/12')
1	1881	92	32	1.10	2.800-3.000
2	1882	92	32	1.30	3.200-3.500
3	1883	92	32	1.60	3.700-4.000
4	1884	92.5	32.5	1.80	4.100-4.400

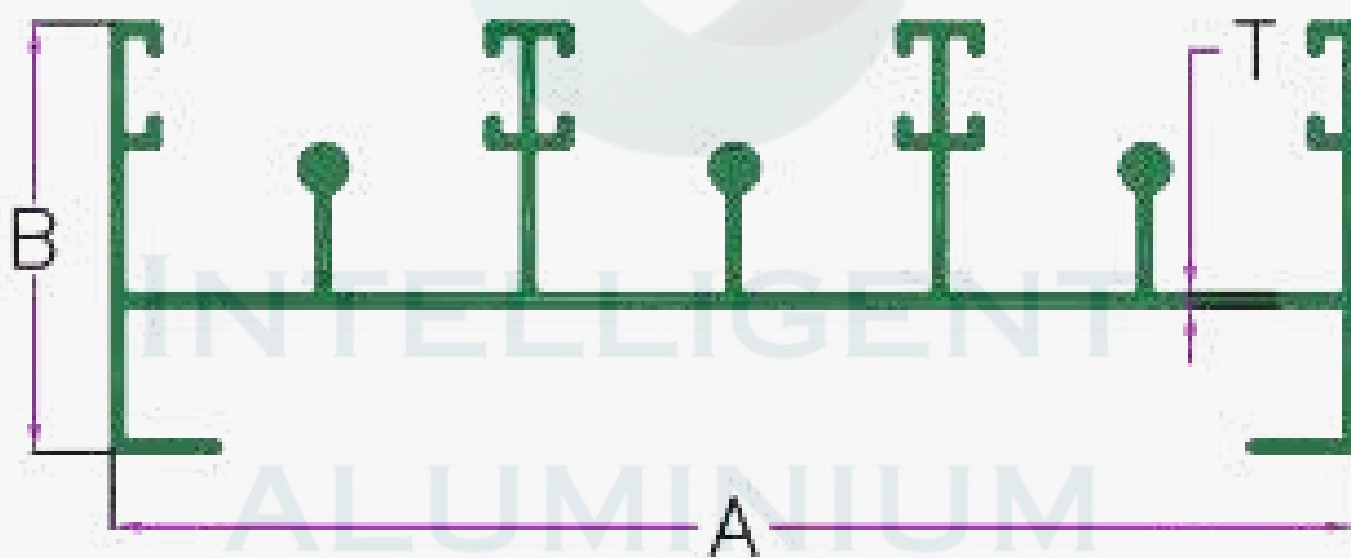

3/4" 3 TRACK BOTTOM

Sl. No.	Section No.	A IN mm.	B IN mm.	T IN mm.	Weight. (KG./ 12')
1	1891	92	32	0.95	2.800-3.000
2	1892	92	32	1.20	3.200-3.500
3	1893	92	32	1.50	3.700-4.000
4	1894	92.5	32.5	1.60	4.100-4.350

SLIDING SECTION BOMBAY SLIDING



INTELLIGENT
ALUMINIUM
itswallpanel.com

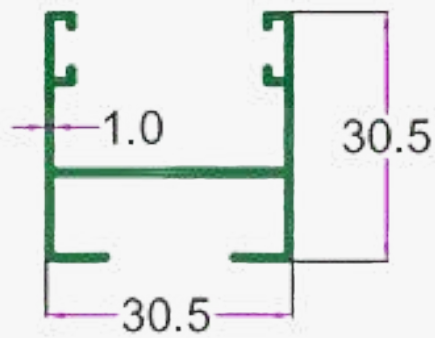

SEC. NO. 1896
WT. 1.100 To 1.300 KG/12'

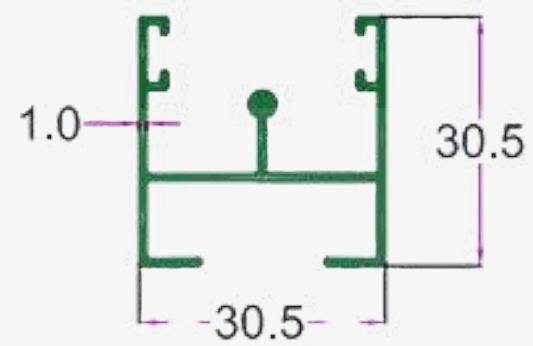

SEC. NO. 1897
WT. 1.200 To 1.400 KG/12'

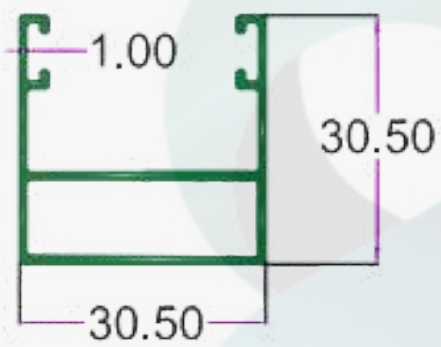

SEC. NO. 1898
WT. 1.400 To 1.600 KG/12'

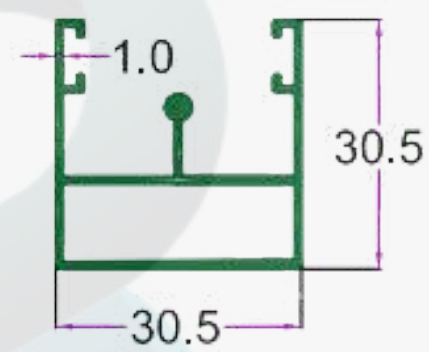

SEC. NO. 1899
WT. 1.550 To 1.750 KG/12'

INTELLIGENT
ALUMINIUM
itswallpanel.com

SLIDING SECTION BOMBAY SLIDING



INTELLIGENT
ALUMINIUM
itswallpanel.com

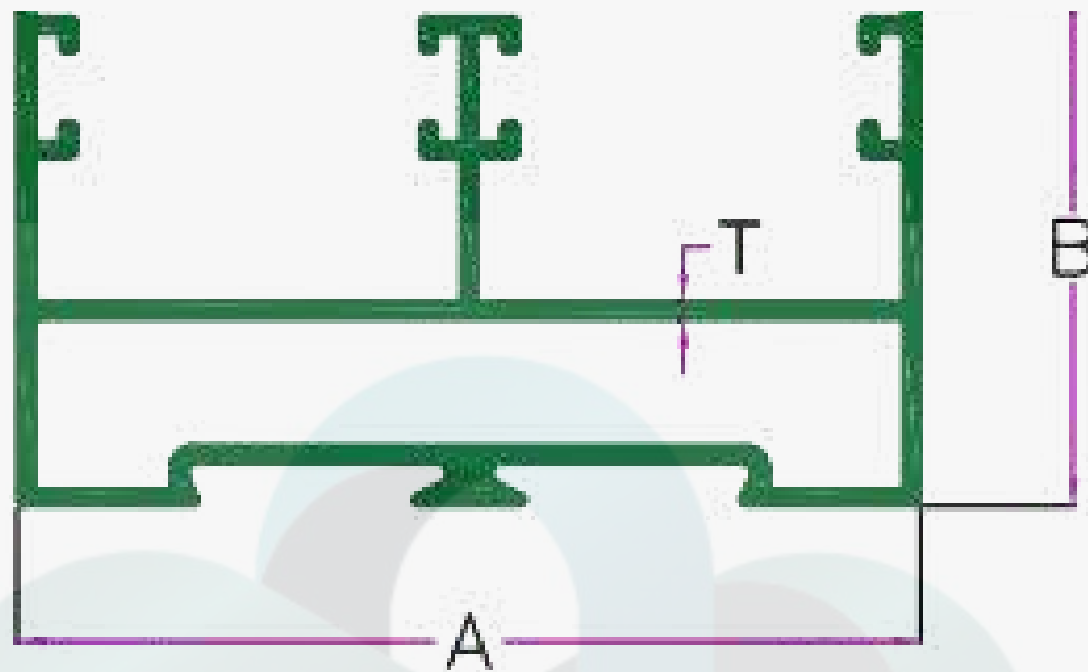

S.P. 2 TRACK TOP

Sl. No.	Section No.	A IN mm.	B IN mm.	T IN mm.	Weight. (KG./ 15')
1	1951	63.00	32	1.20	4.200-4.500
2	1952	63.00	32	1.40	4.100-4.700
3	1953	63.00	34	1.20	3.800-4.500
4	1954	63.50	33	1.20	3.800-4.300

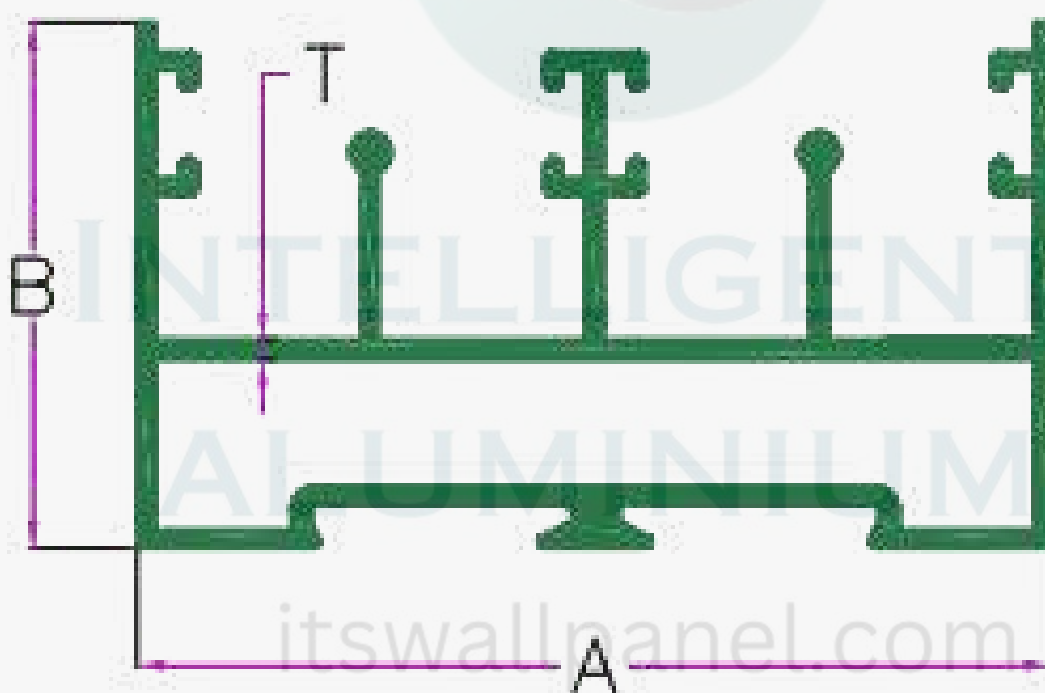

S.P. 2 TRACK BOTTOM

S. No.	Section No.	A IN mm.	B IN mm.	T IN mm.	Weight. (KG./15')
1	1961	63.00	32	1.10	4.200-4.500
2	1962	63.00	32	1.30	4.100-4.700
3	1963	63.50	33	1.20	4.200-4.800

SLIDING SECTION BOMBAY SLIDING



INTELLIGENT
ALUMINIUM
itswallpanel.com

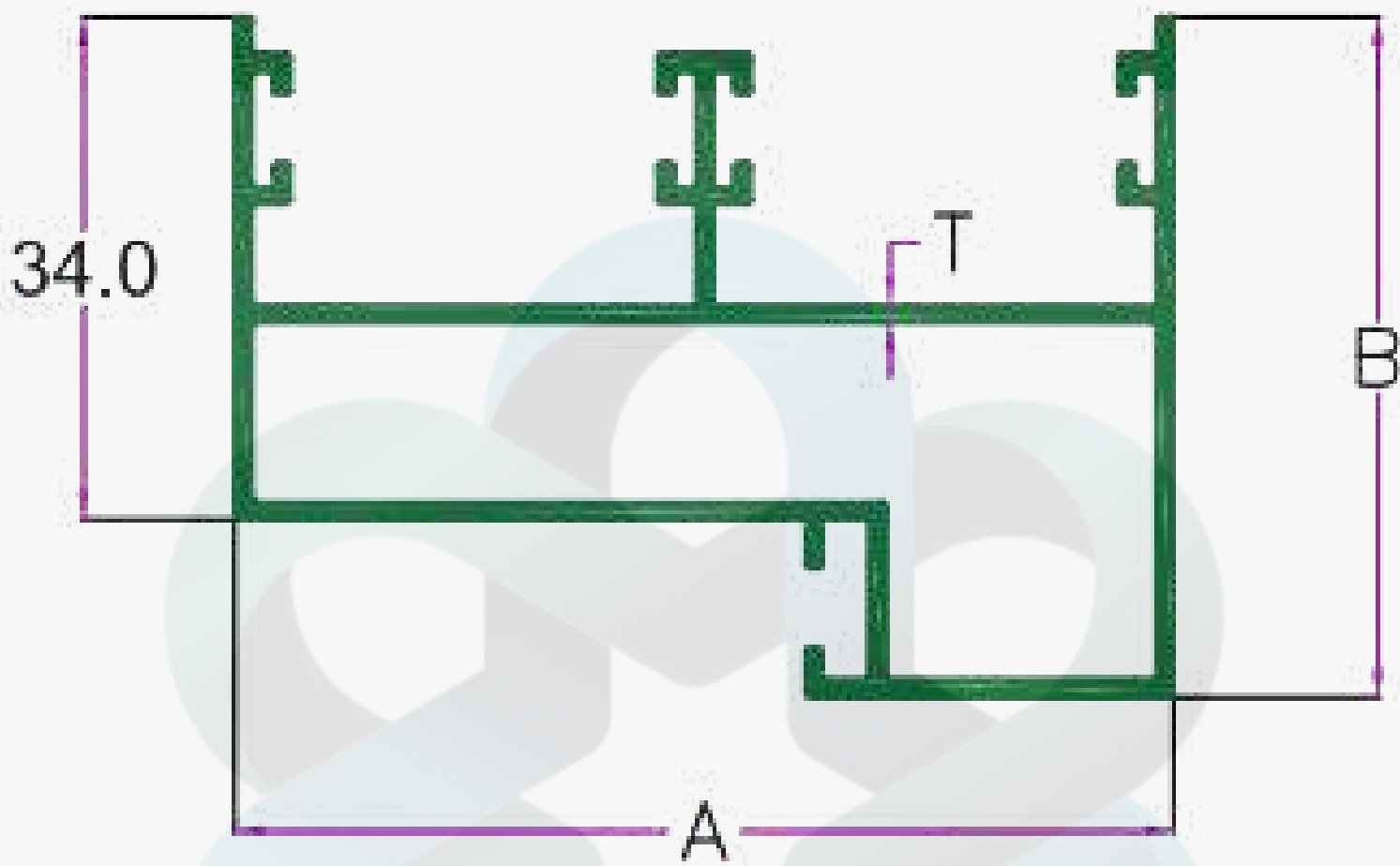

GHUNDI BOTTOM TWO TRACK

S. No.	Section No.	A IN mm.	B IN mm.	T IN mm.	Weight. (KG./ 15')
1	1965	63.00	46	1.00	4.000-4.600
2	1966	63.00	46	1.20	4.200-4.800
3	1967	63.50	46	1.20	4.200-4.800

ALUMINIUM

itswallpanel.com

SLIDING SECTION BOMBAY SLIDING



INTELLIGENT
ALUMINIUM
itswallpanel.com

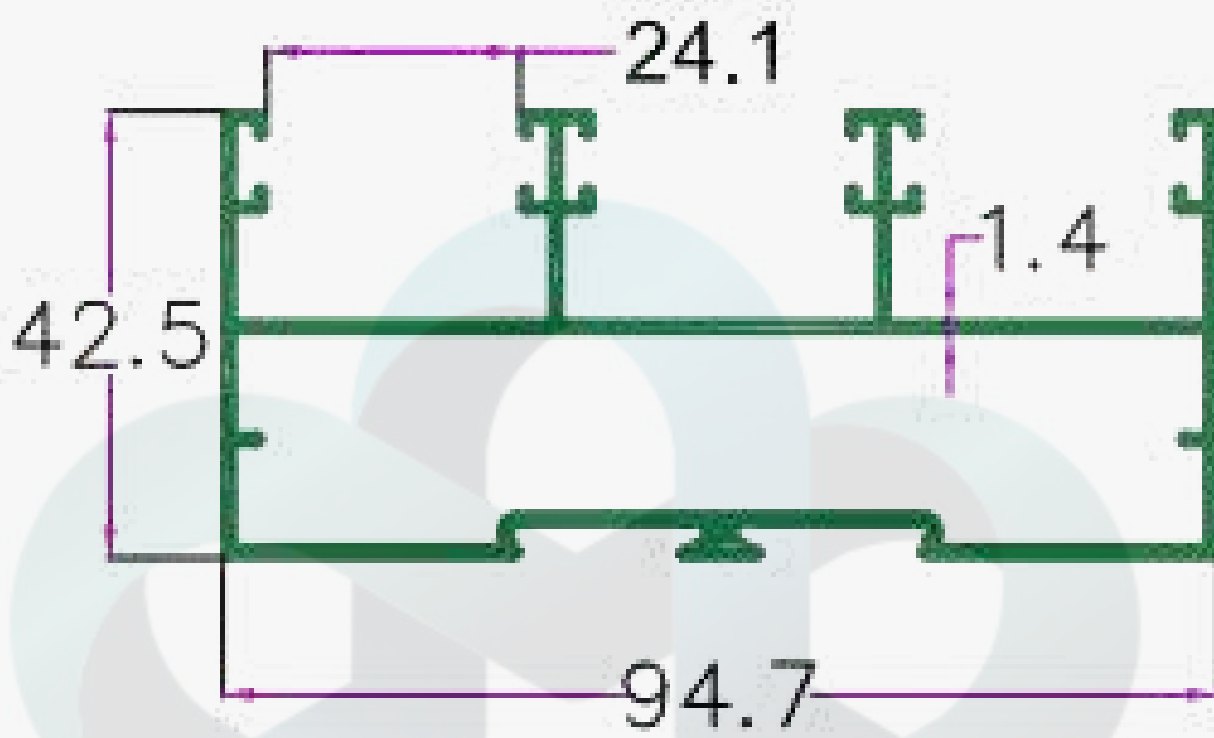

SEC.NO.1968

WT. 6.700 TO 6.840 KG/15'

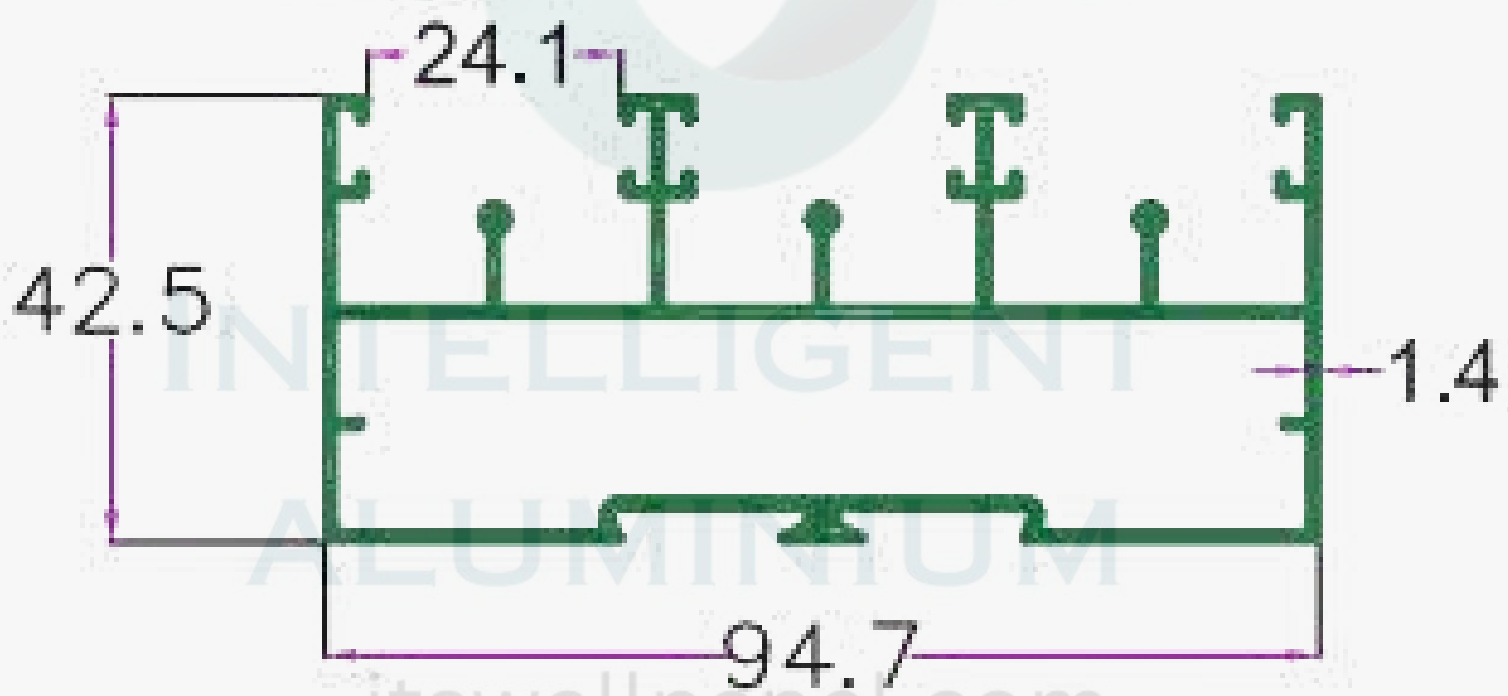

SEC.NO. 1969

WT. 6.900 TO 7050 KG/15'

SLIDING SECTION BOMBAY SLIDING



INTELLIGENT
ALUMINIUM
itswallpanel.com

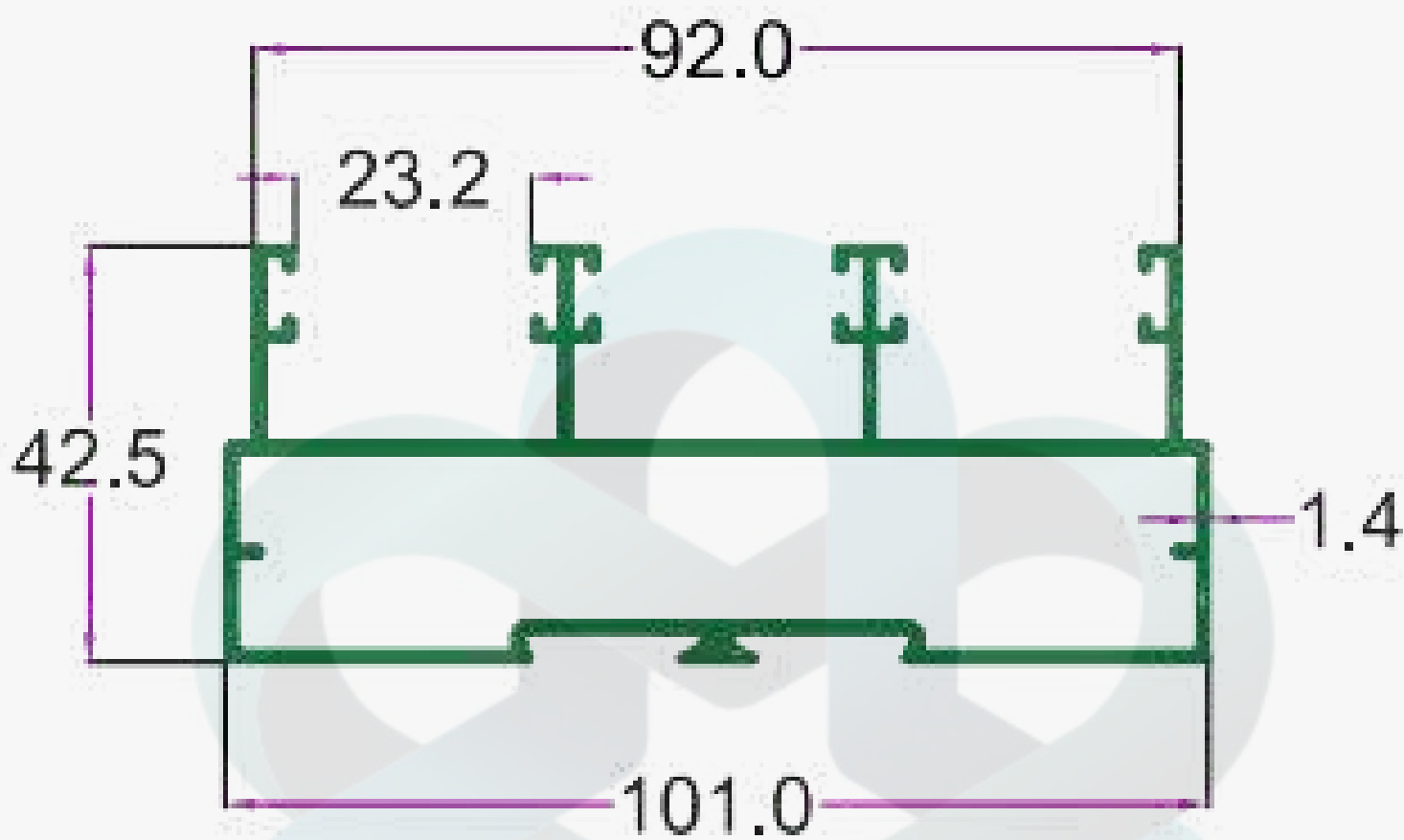

SEC.NO. 1970

WT. 7.900 TO 8.120 KG/15'

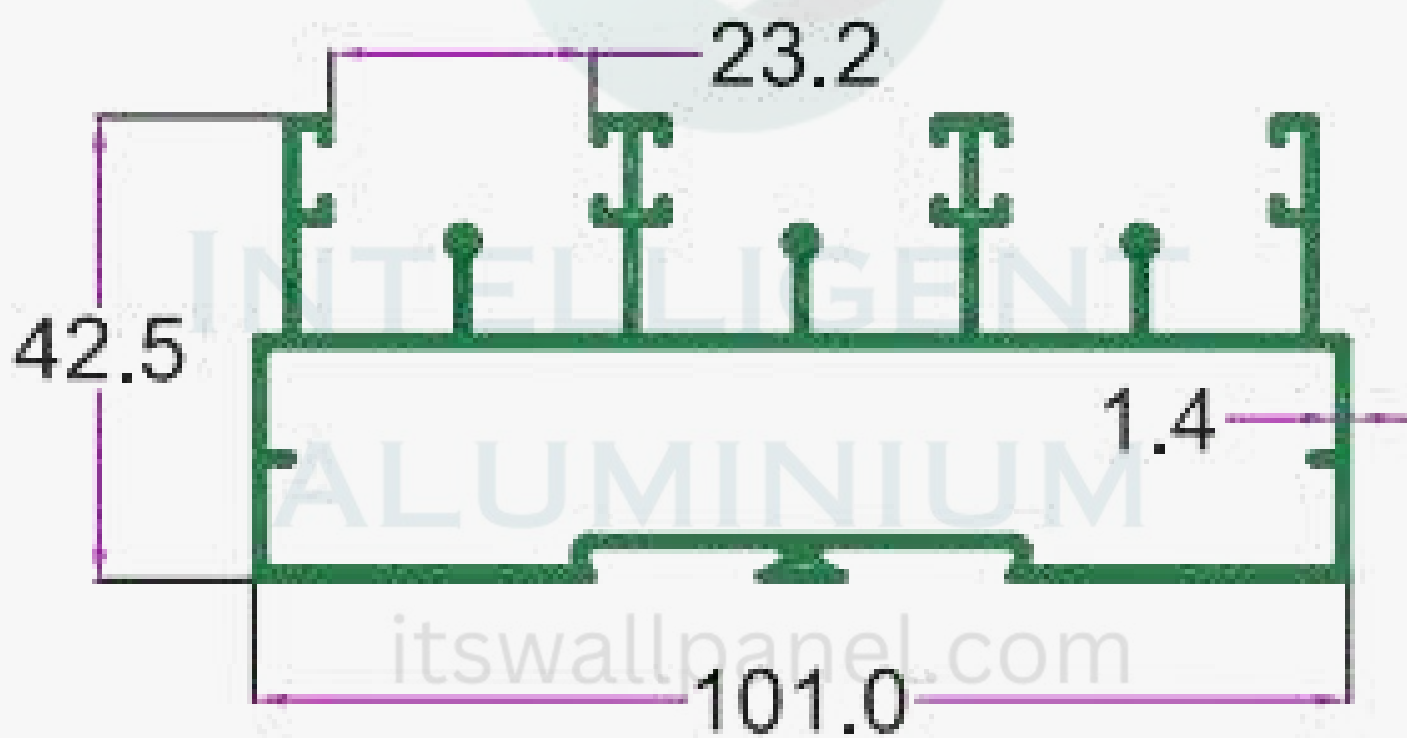

SEC.NO. 1971

WT. 6.200 TO 6.350 KG/12'

SLIDING SECTION BOMBAY SLIDING 20 MM



INTELLIGENT
ALUMINIUM
itswallpanel.com

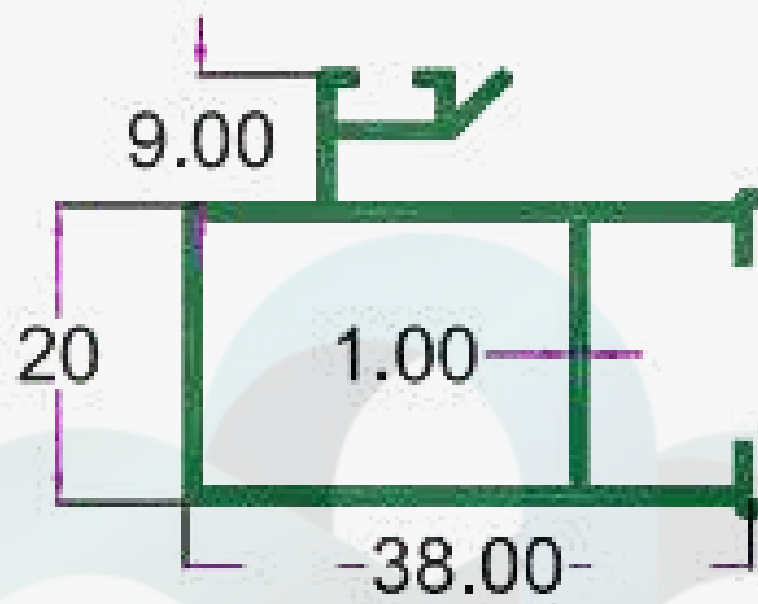

S.No.	Section No.	A IN mm	B IN mm	Weight (KG./12")
1	1910	38.00	20	1.100 - 1.300
2	1910	38.00	20	1.300 - 1.500
3	1910	38.00	20	1.600 - 1.800
4	1910	38.00	20	1.800 - 2.000

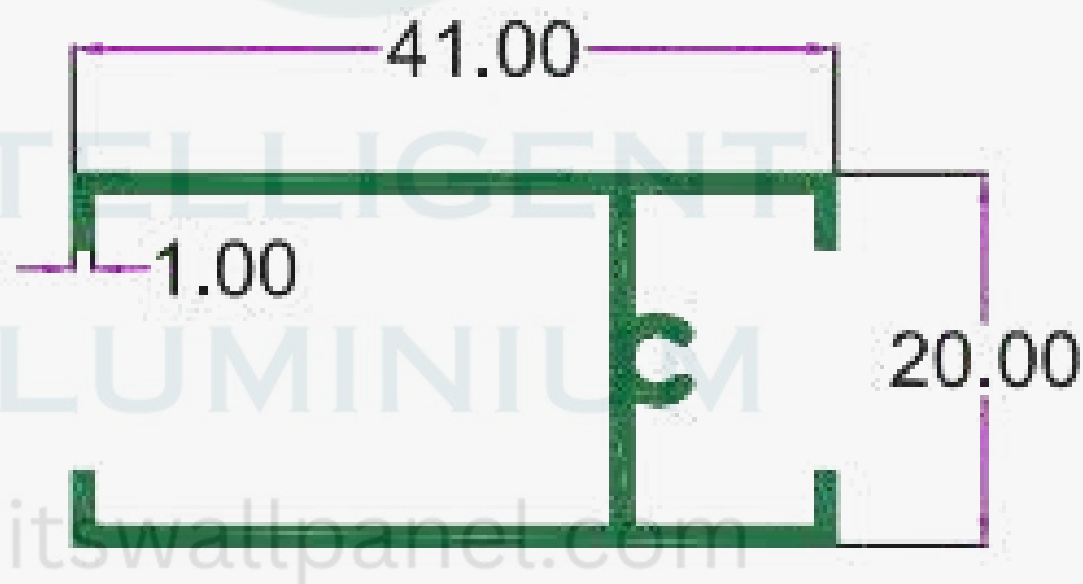

S.No.	Section No.	A IN mm	B IN mm	Weight (KG./12")
1	1912	41.00	20	1.100 - 1.300
2	1912	41.00	20	1.300 - 1.500
3	1912	41.00	20	1.500 - 1.700

SLIDING SECTION BOMBAY SLIDING 20 MM



INTELLIGENT
ALUMINIUM
itswallpanel.com

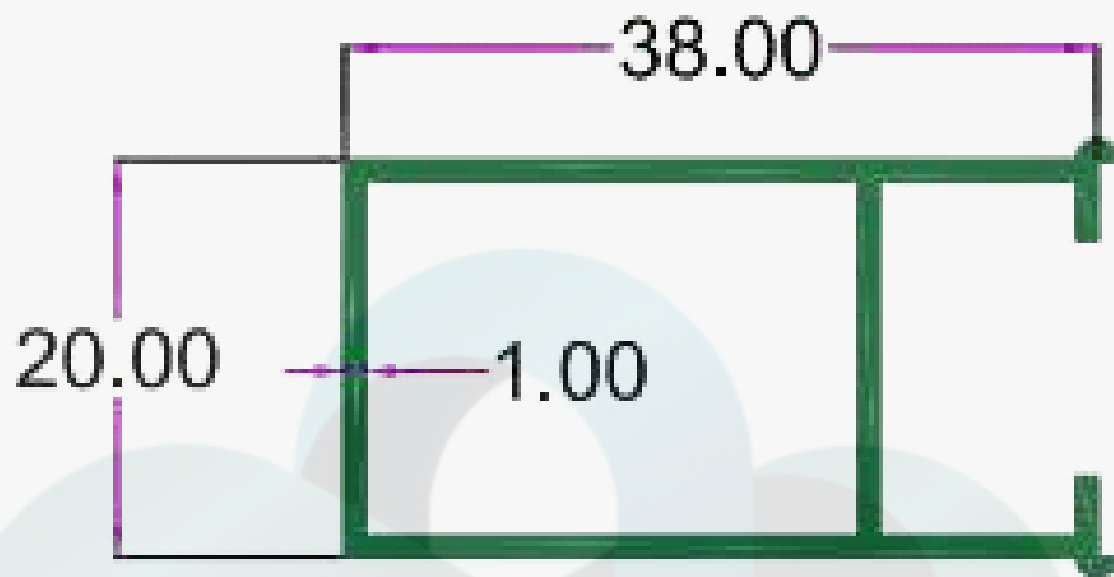

S.No.	Section No.	A IN mm	B IN mm	Weight (KG./12')
i	1911	38.00	20	1.100 - 1.300
2	1911	38.00	20	1.300 - 1.500
3	1911	38.00	20	1.600 - 1.800
4	1911	38.00	20	2.000 - 2.200

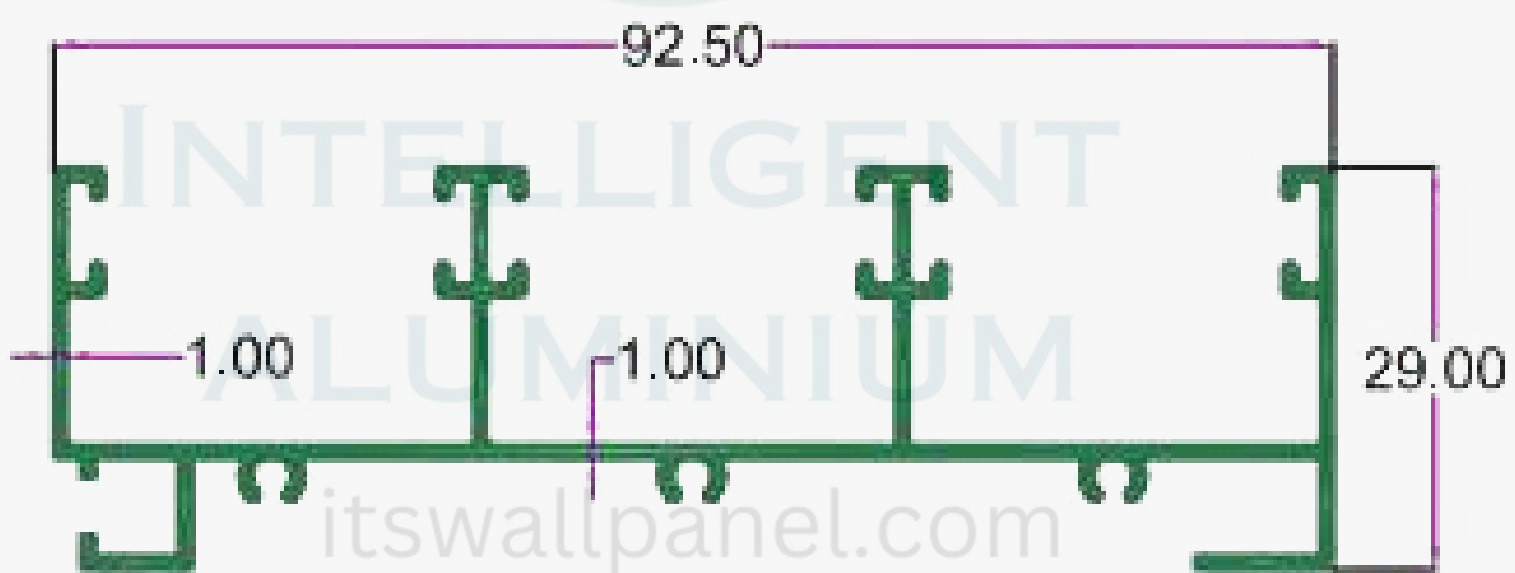

S.No.	Section No.	A IN mm	B IN mm	Weight (KG./12')
i	1915	62.00	29.00	2.700 - 3.000
2	1915	62.00	29.00	3.000 - 3.200

SLIDING SECTION BOMBAY SLIDING 20 MM



INTELLIGENT
ALUMINIUM
itswallpanel.com

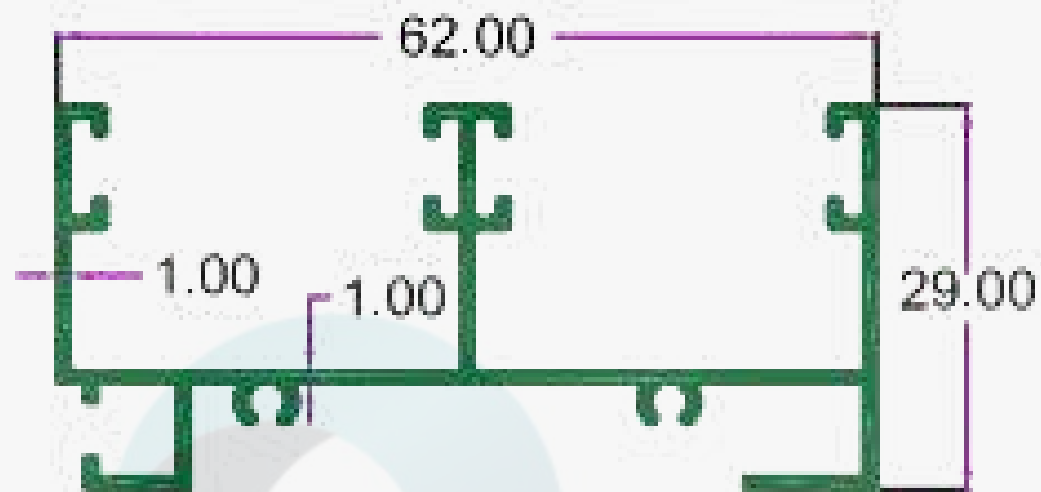

S.No.	Section No.	A IN mm.	B IN mm.	Weight (KG./12')
1	1913	62.00	29.00	1.600 - 1.800
2	1913	62.00	29.00	2.000 - 2.200

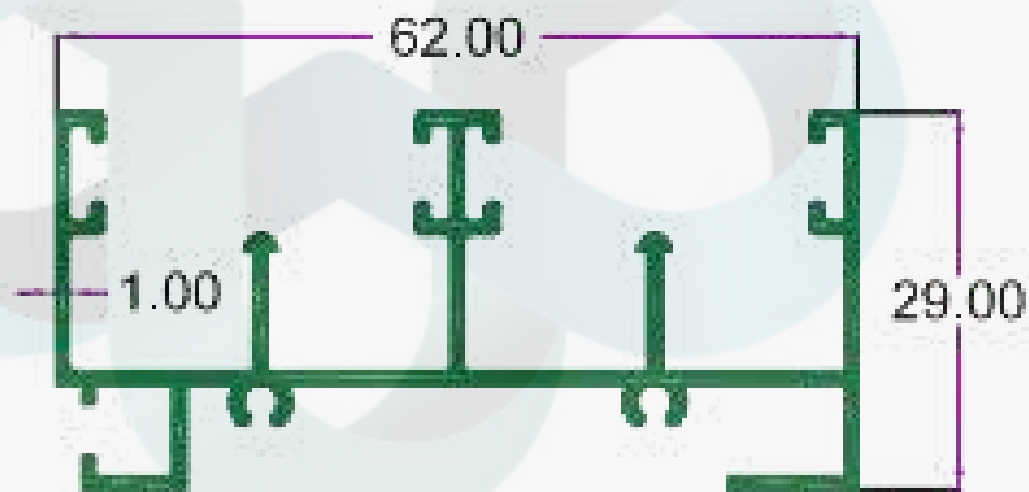

S.No.	Section No.	A IN mm	B IN mm	Weight (KG./12')
1	1914	62.00	29.00	1.600 - 1.800
2	1914	62.00	29.00	2.000 - 2.200

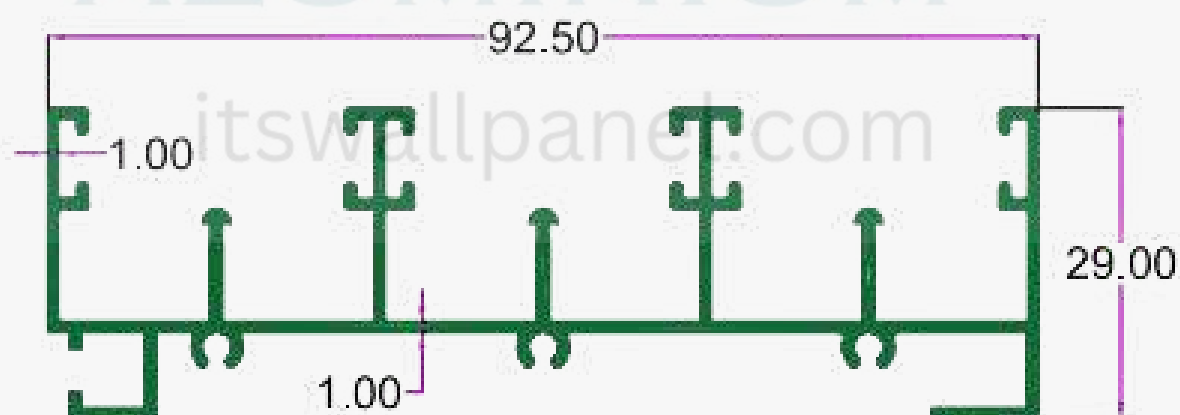

S.No.	Section No.	A IN mm	B IN mm	Weight (KG./12')
1	1916	92.50	29.00	2.700 - 3.000

SLIDING SECTION BOMBAY SLIDING



INTELLIGENT
ALUMINIUM
itswallpanel.com

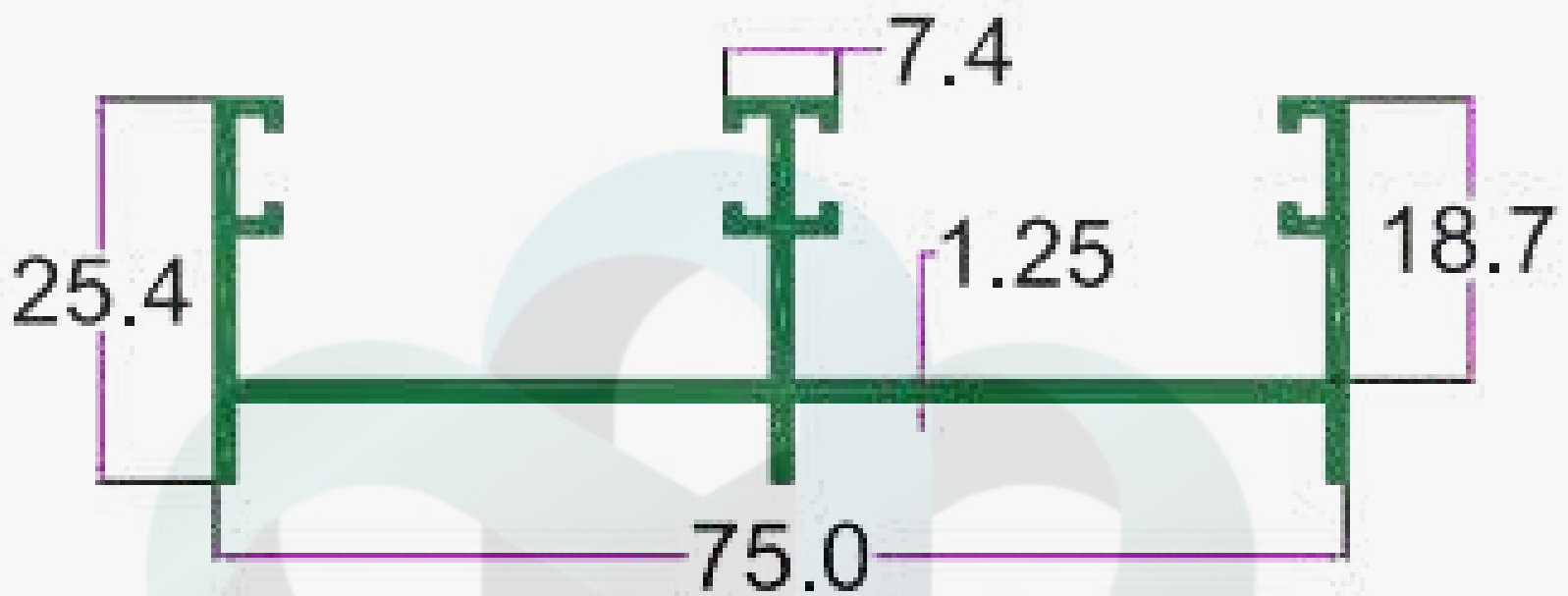

SEC. NO. 1989

WT. 3.700 TO 3.900 KG/15'

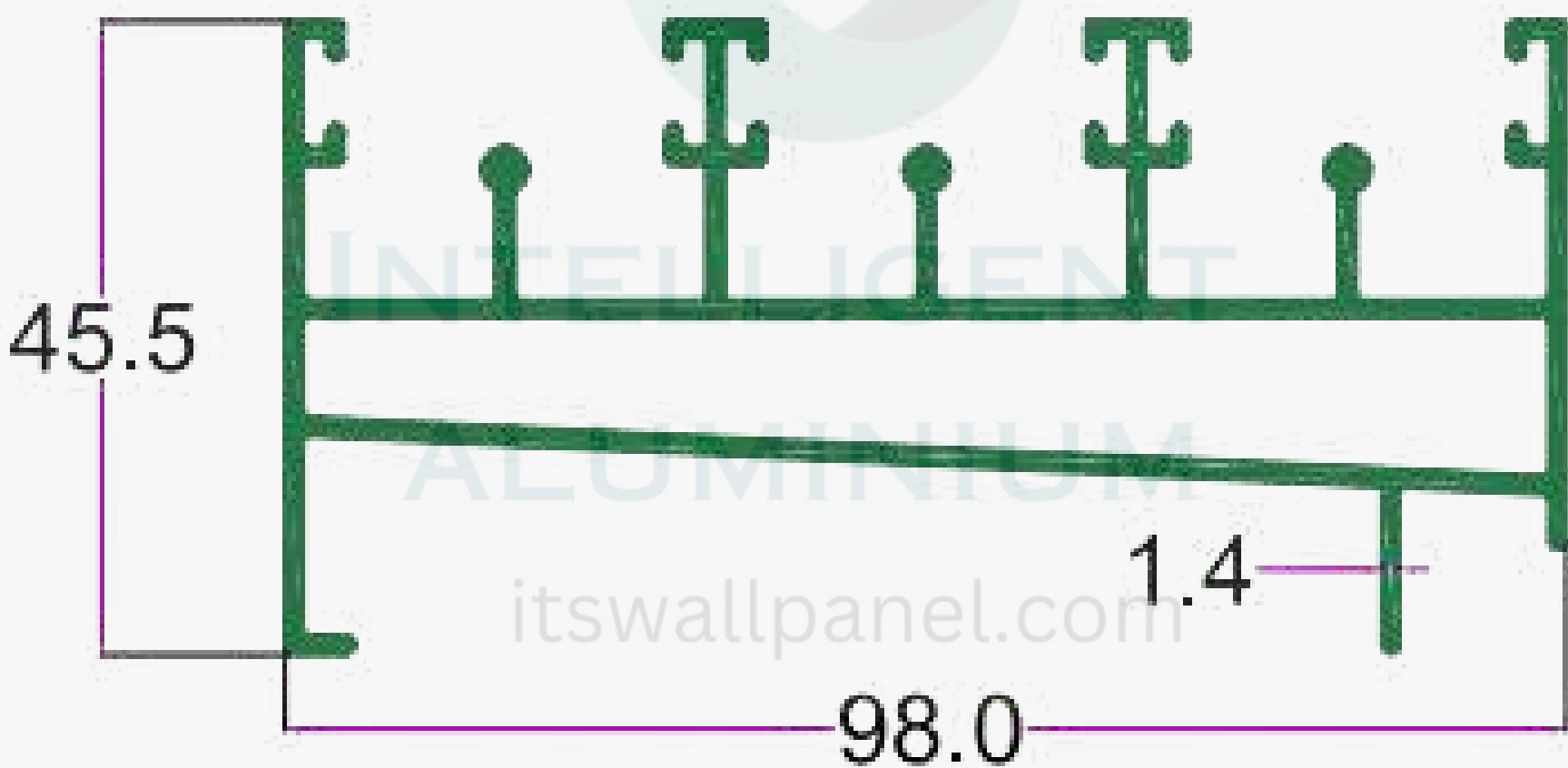

SEC. NO. 3102

WT. 5.760 TO 5.900 KG/12'

SLIDING SECTION BOMBAY SLIDING



INTELLIGENT
ALUMINIUM
itswallpanel.com

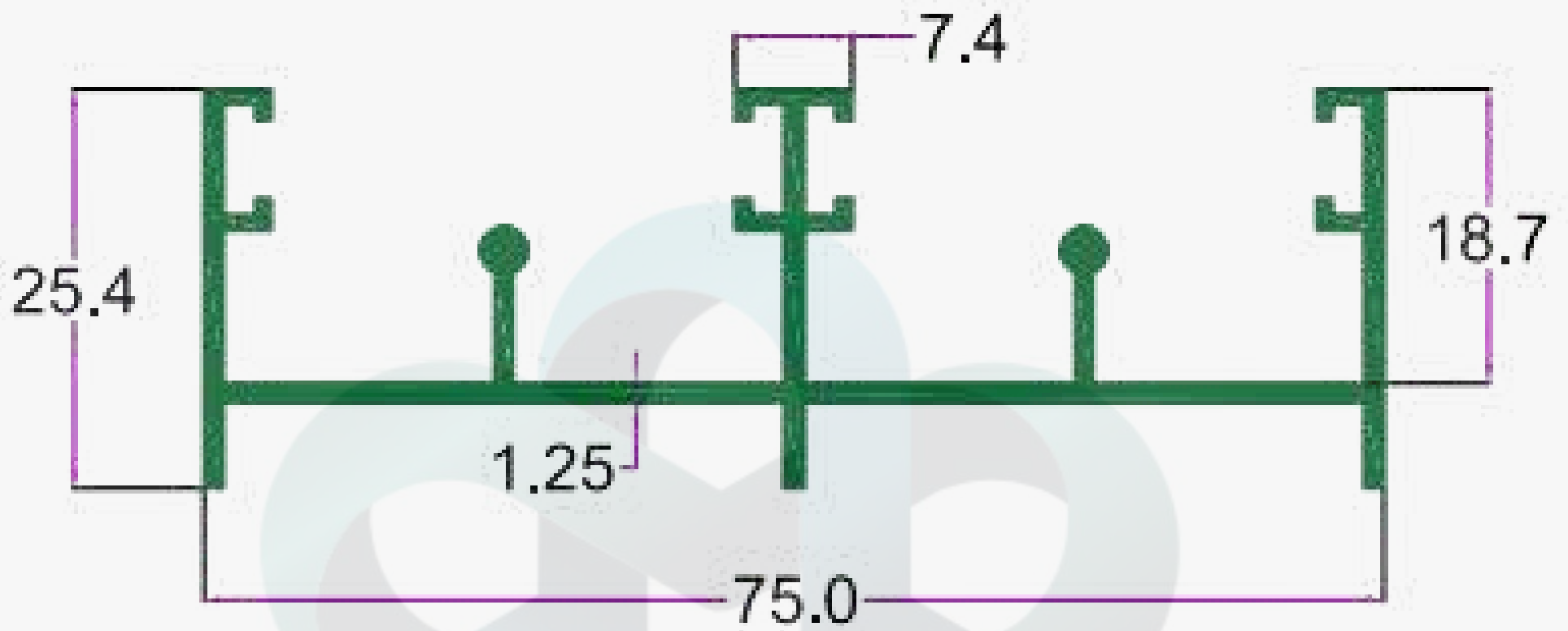

SEC. NO. 1990

WT. 3.900 TO 4.100 KG/15'

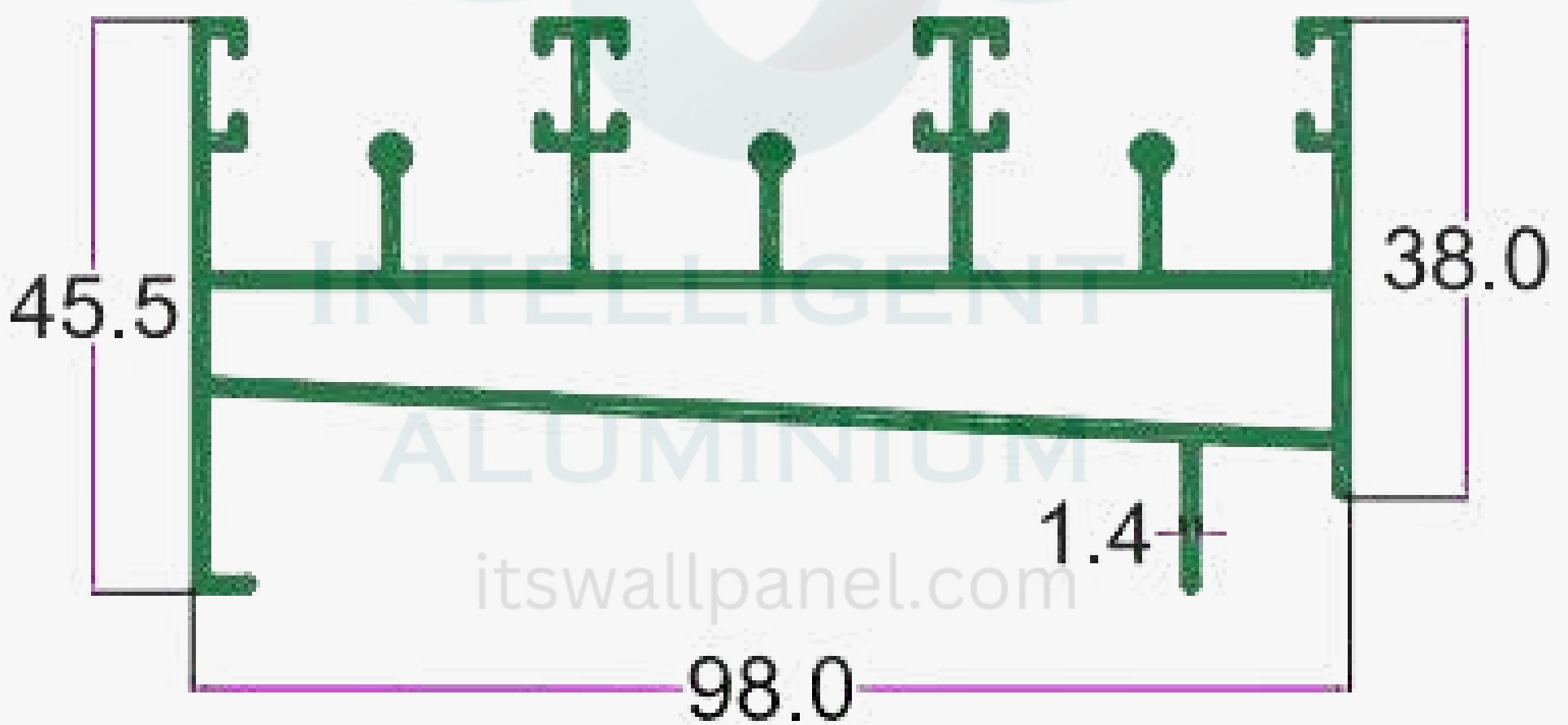

SEC. NO. 3102

WT. 5.760 TO 5.900 KG/12'

SLIDING SECTION BOMBAY SLIDING



INTELLIGENT
ALUMINIUM
itswallpanel.com

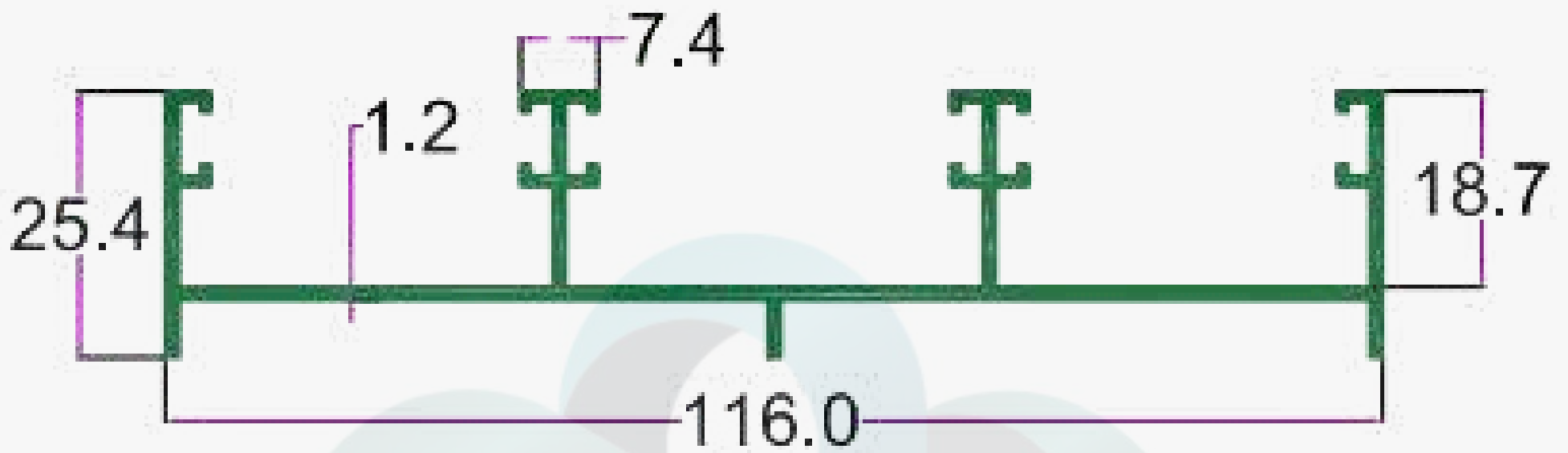

SEC. NO. 1991

WT. 4.500 TO 4.700 KG/12'

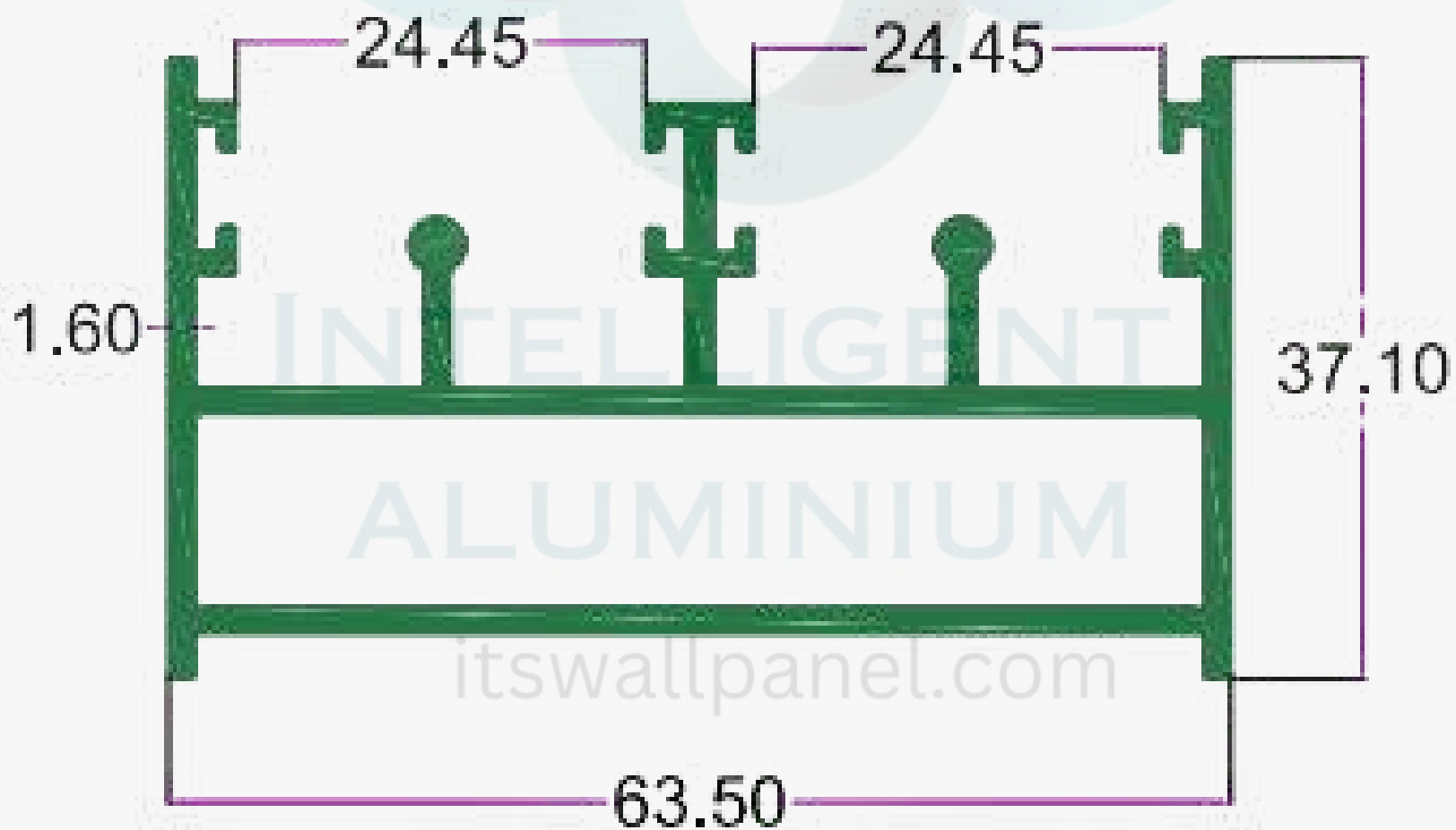

SEC. NO. 4100

WT. 4.120 TO 4.350 KG/12'

SLIDING SECTION BOMBAY SLIDING



INTELLIGENT
ALUMINIUM
itswallpanel.com

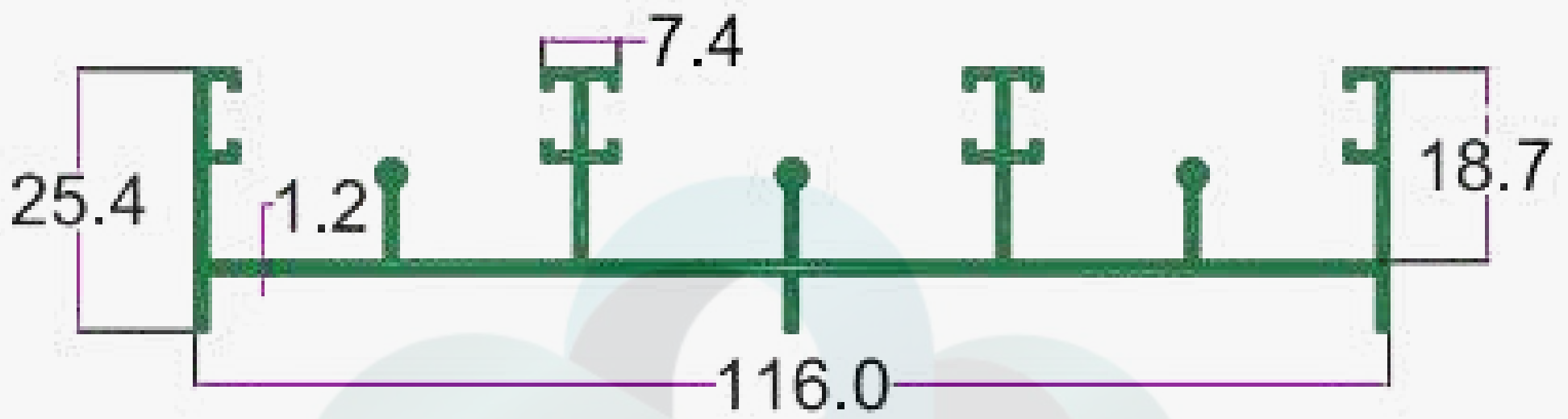

SEC. NO. 1992

WT. 6.400 TO 6.600 KG/15'

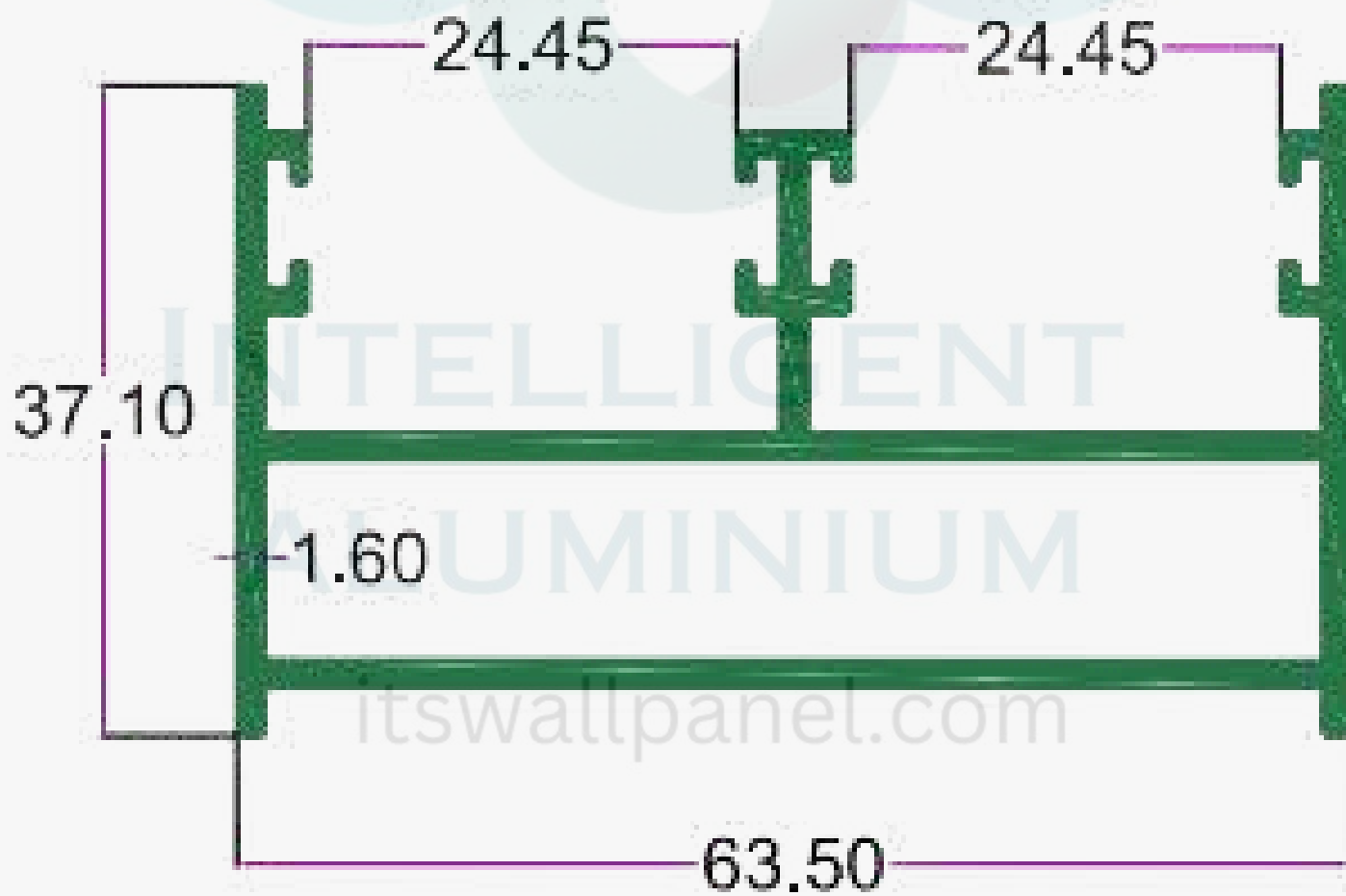

SEC. NO. 4102

WT. 3.750 TO 4.100 KG/12'

SLIDING SECTION BOMBAY SLIDING



INTELLIGENT
ALUMINIUM
itswallpanel.com

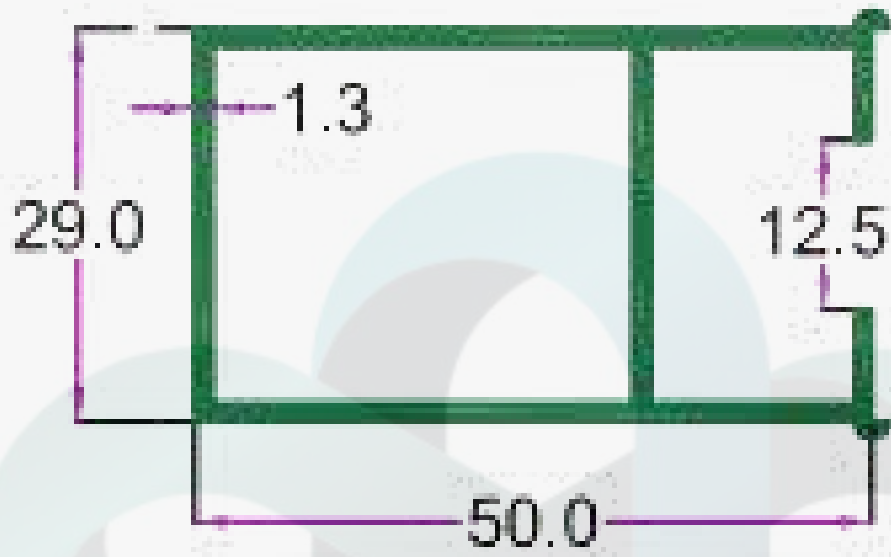

SEC. NO. 1901
WT. 1.650 TO 1.850 KG/12'

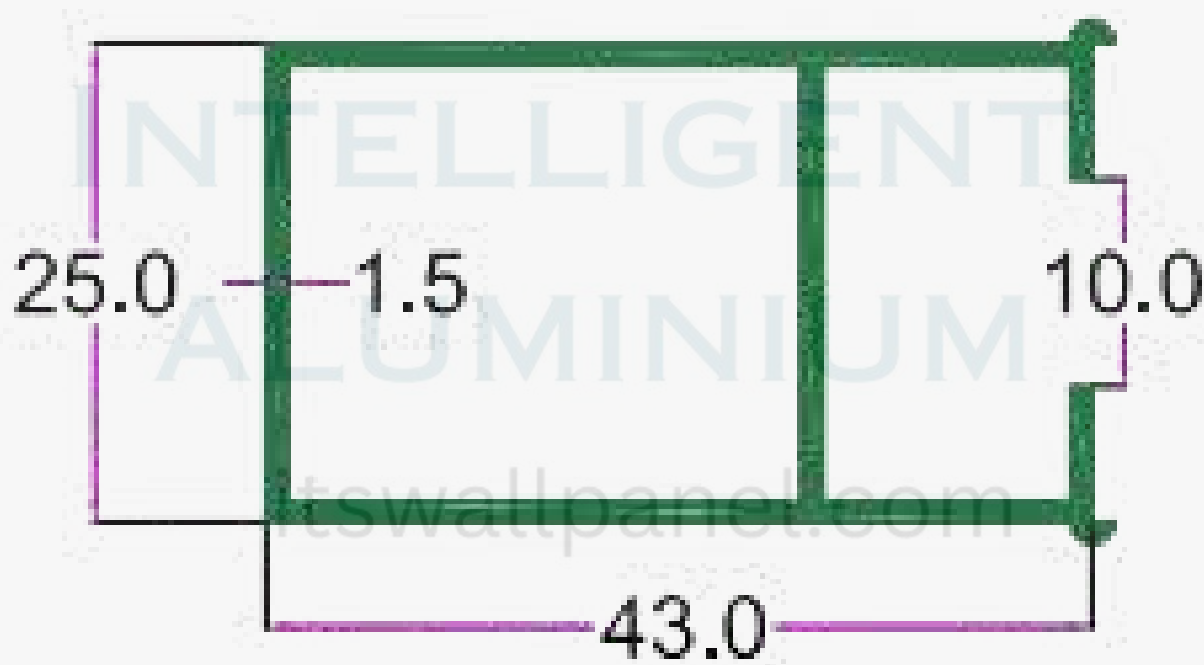

SEC.No. 2045
WT. 2.180 TO 2.300 KG/12'

SLIDING SECTION BOMBAY SLIDING



INTELLIGENT
ALUMINIUM
itswallpanel.com

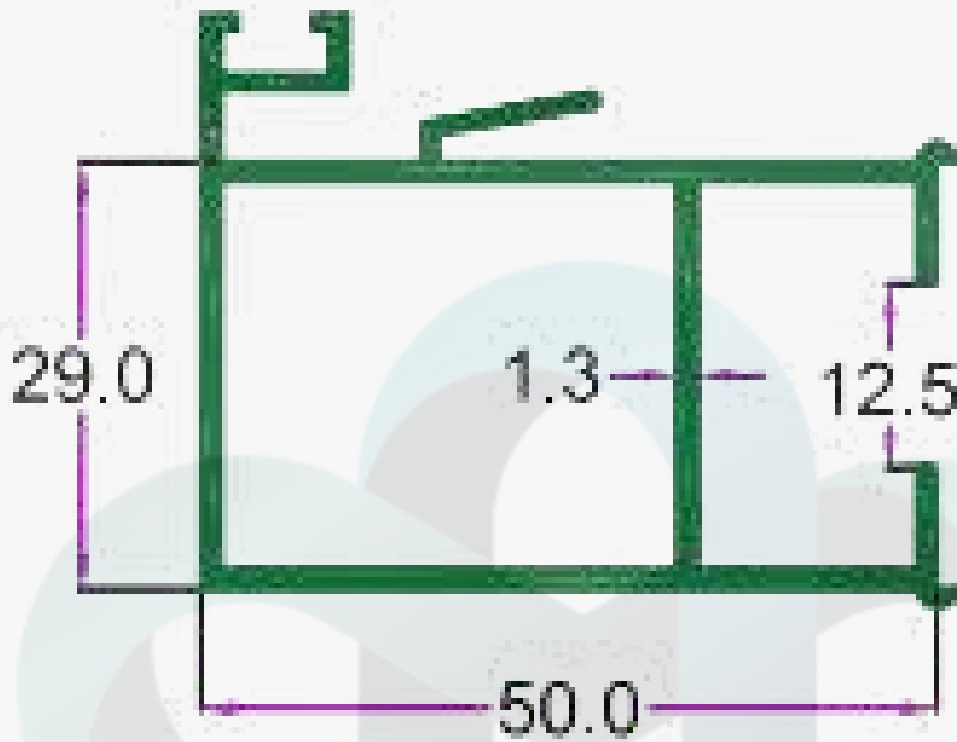

SEC. NO. 1902

WT. 2.500 TO 2.800 KG/12'

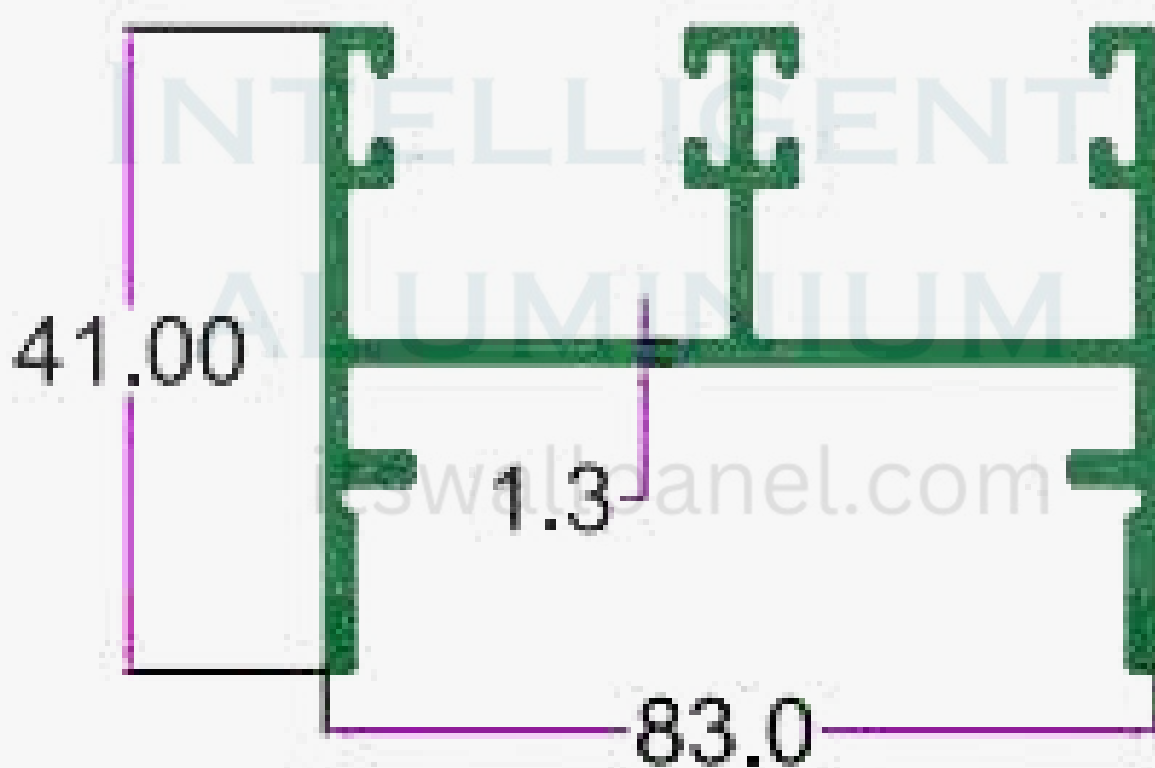

SEC. NO. 1904

WT. 2.883 TO 3.132 KG/12'

SLIDING SECTION BOMBAY SLIDING



INTELLIGENT
ALUMINIUM
itswallpanel.com

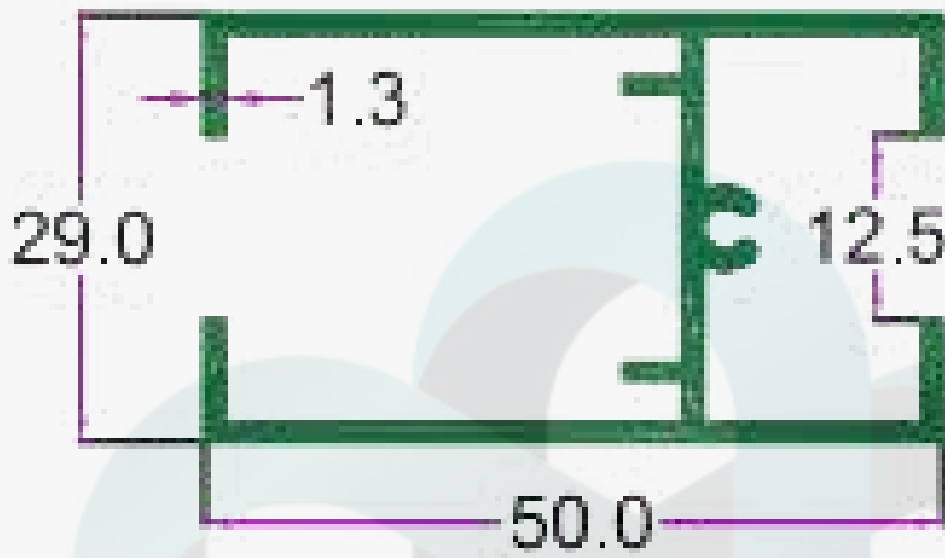

SEC. NO. 1903

WT. 1.950 TO 2.100 KG/12'

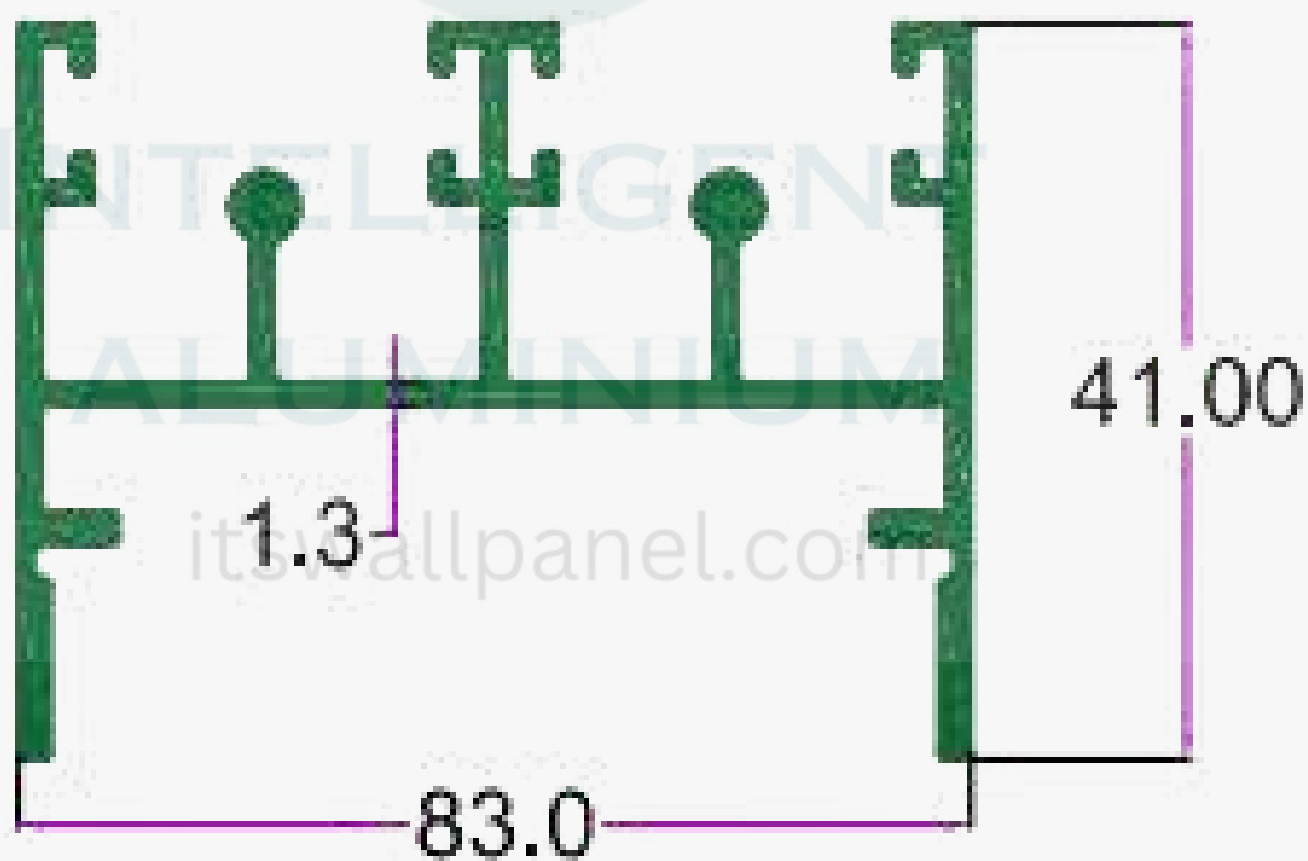

SEC. NO. 1905

WT. 3.260 TO 3.600 KG/12'

SLIDING SECTION BOMBAY SLIDING



INTELLIGENT
ALUMINIUM
itswallpanel.com

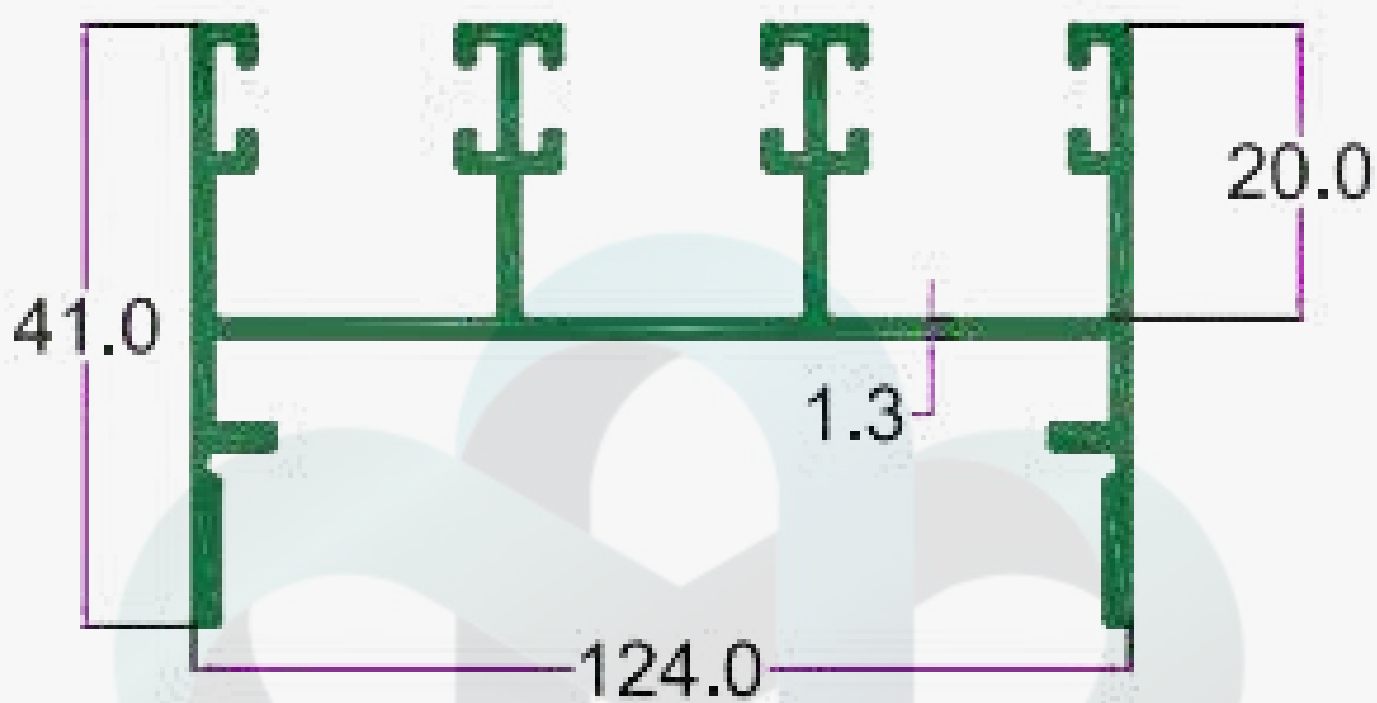

SEC. NO. 1906

WT. 3.782 TO 4.180 KG/12'

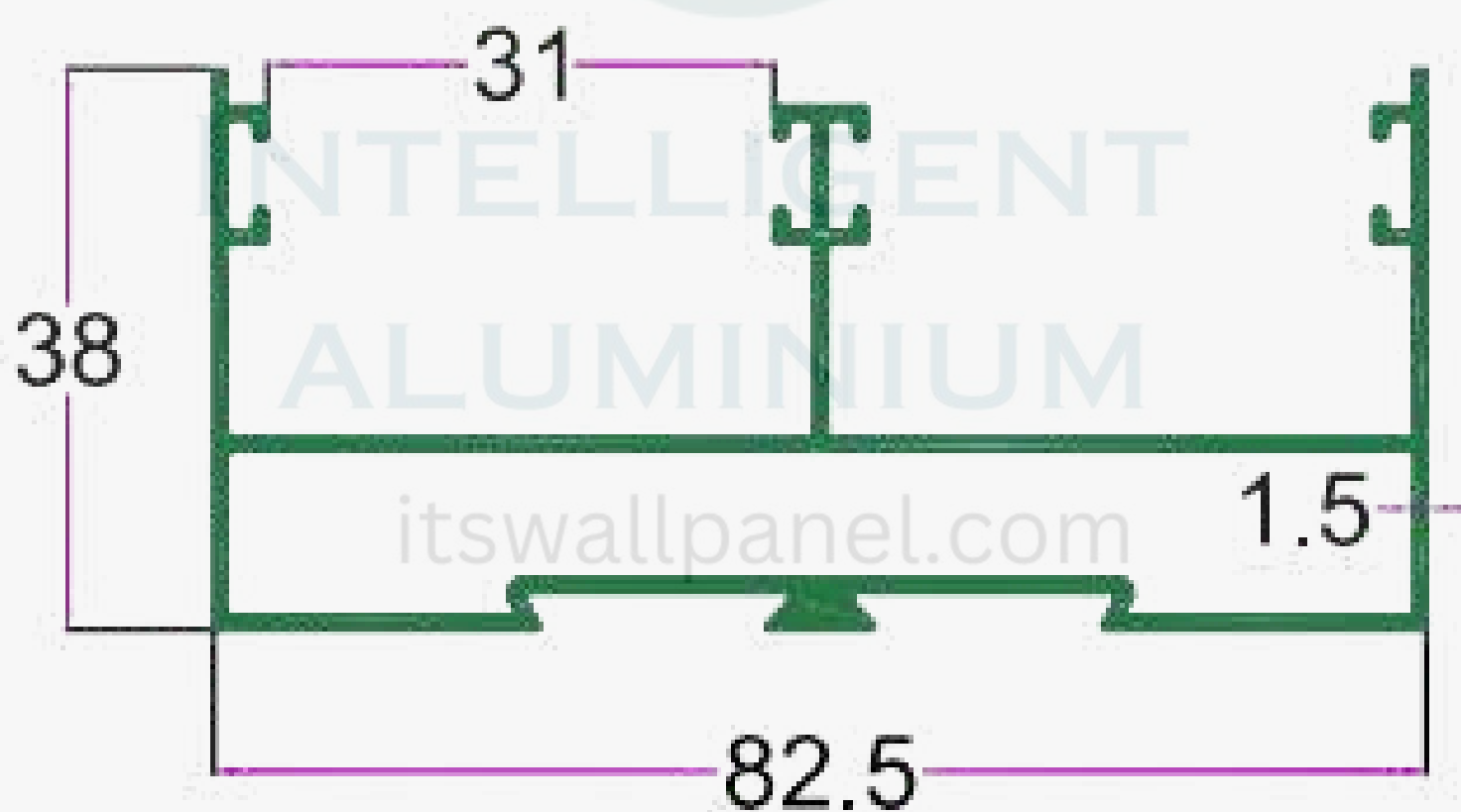

SEC. NO. 1908

WT. 5.400 TO 5.700 KG/12'

SLIDING SECTION BOMBAY SLIDING



INTELLIGENT
ALUMINIUM
itswallpanel.com

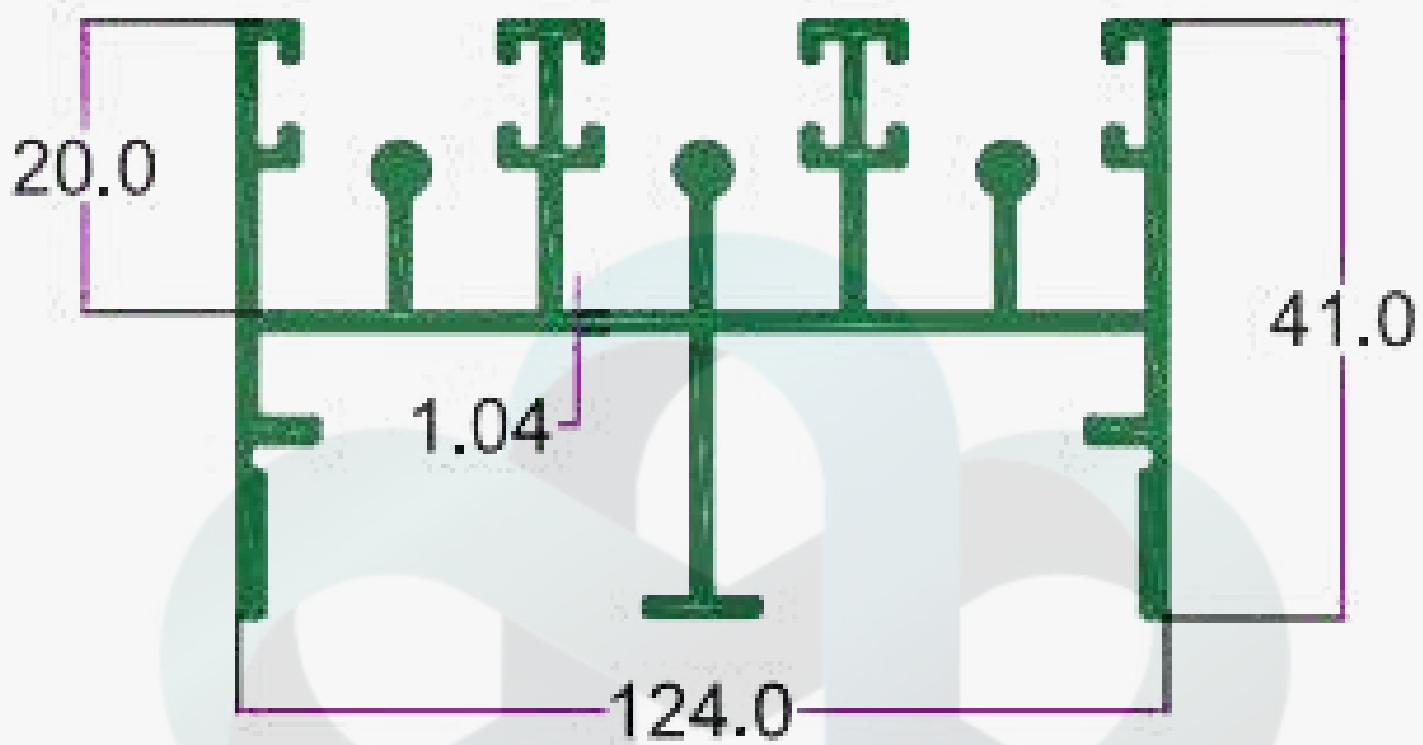

SEC. NO. 1907

WT. 4.870 TO 5.380 KG/12'

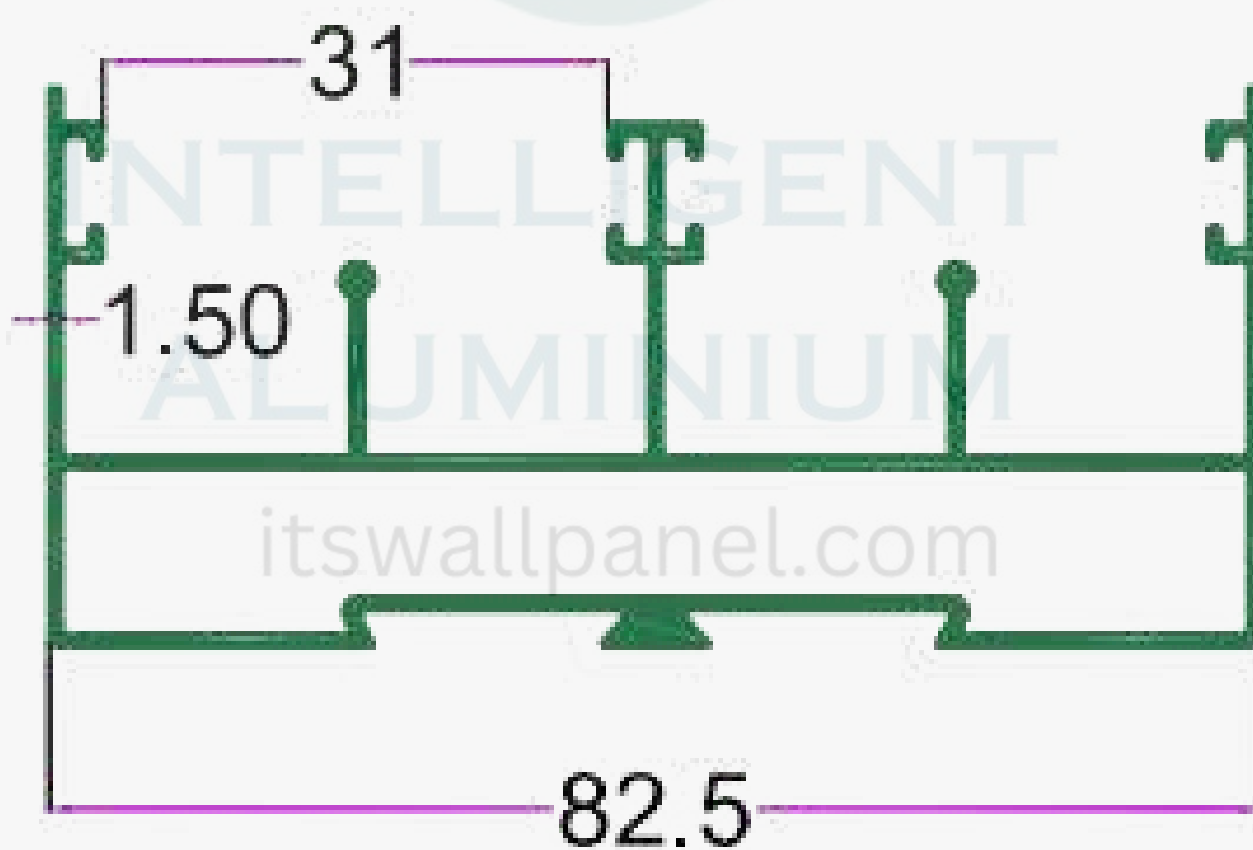

SEC. NO. 1909

WT. 5.400 TO 5.700 KG/12'

SLIDING SECTION BOMBAY SLIDING



INTELLIGENT
ALUMINIUM
itswallpanel.com

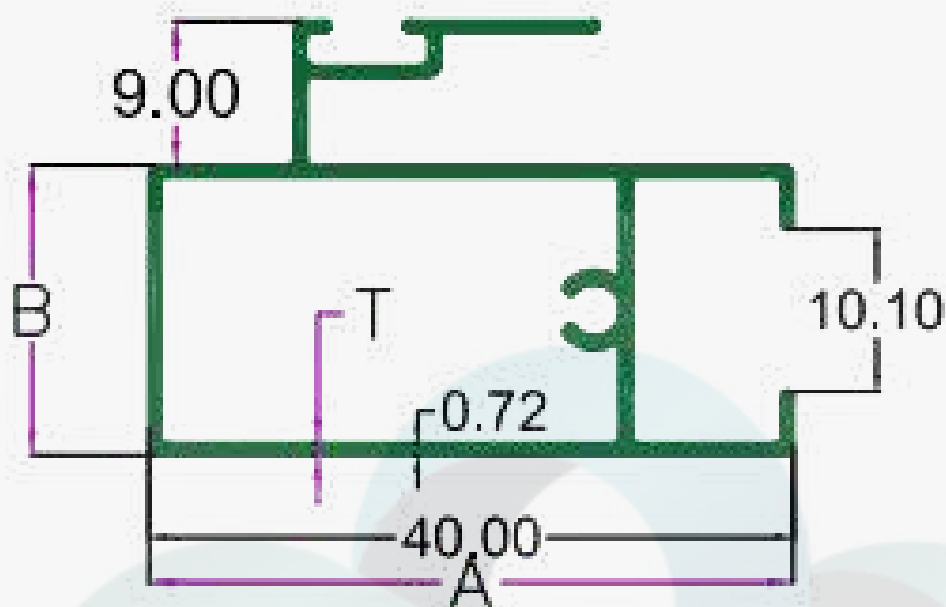

3/4" INTER LOCK

S. No.	Section No.	A in mm.	B in mm.	T in mm.	Weight (KG/12')
1	1801	40.00	18.00	0.85	1.200-1.300
2	1802	40.00	18.00	1.20	1.400-1.500
3	1803	40.00	18.00	1.40	1.600-1.800
4	1804	40.00	18.00	1.55	2.000-2.200
5	1805	40.00	18.00	2.50	2.700-3.000

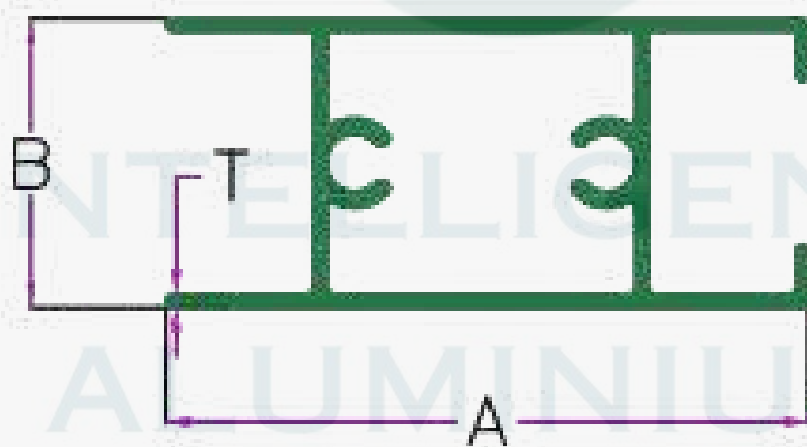

3/4" BOTTOM TOP

Sl No.	Section No.	A in mm.	B in mm.	T in mm.	Weight (KG/12')
1	1821	40.00	18.00	1.00	1.200-1.300
2	1822	40.00	18.00	1.20	1.400-1.500
3	1823	40.00	18.00	1.40	1.600-1.800
4	1824	40.00	18.00	1.60	2.000-2.200
5	1825	40.00	18.00	2.50	2.700-3.000

SLIDING SECTION BOMBAY SLIDING



INTELLIGENT
ALUMINIUM
itswallpanel.com

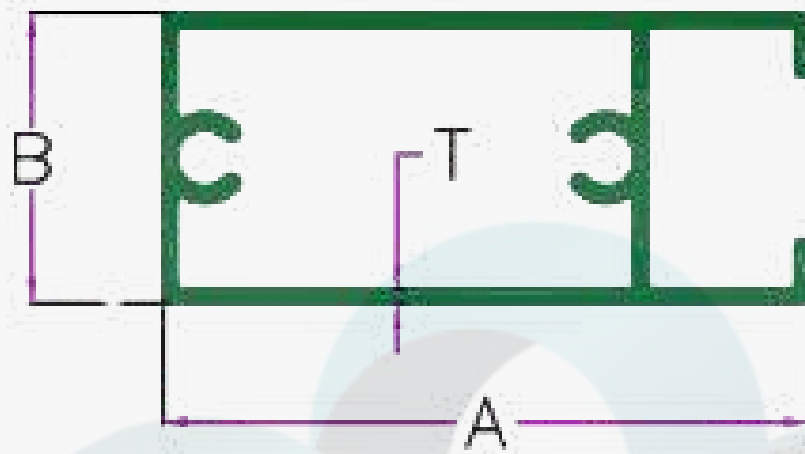

3/4" HANDLE

S.No.	Section No.	A in mm.	B in mm.	T in mm.	Weight (KG/12')
1	1812	40.00	18.00	1.00	1.200-1.300
2	1813	40.00	18.00	1.40	1.600-1.800
3	1814	40.00	18.00	1.55	1.600-1.800
4	1815	40.00	18.00	2.50	2.700-3.000

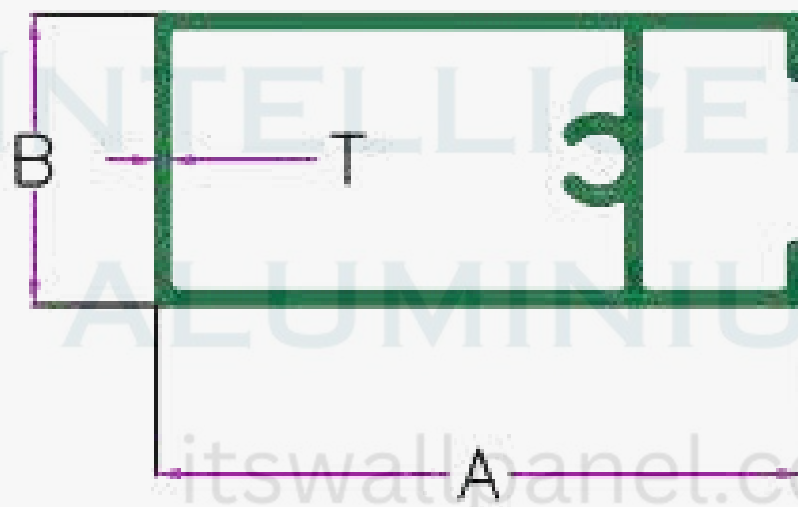

3/4" HANDLE

Sl No.	Section No.	A in mm.	B in mm.	T in mm.	Weight (KG/12')
1	1836	40.00	18.00	0.70	0.750-0.950

SLIDING SECTION BOMBAY SLIDING



INTELLIGENT
ALUMINIUM
itswallpanel.com

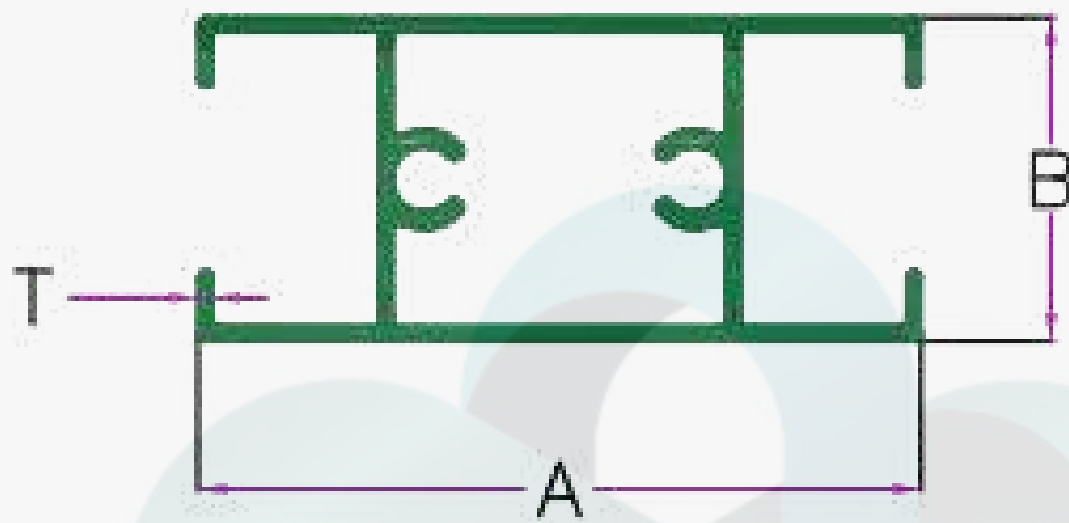

TOP BOTTOM

Sl. No.	Sec. No.	A IN mm.	B IN mm.	T in mm.	Weight (KG/12')
1	1843	40.00	18.00	1.20	1.400-1.500
2	1844	40.00	18.00	1.40	1.600-1.800

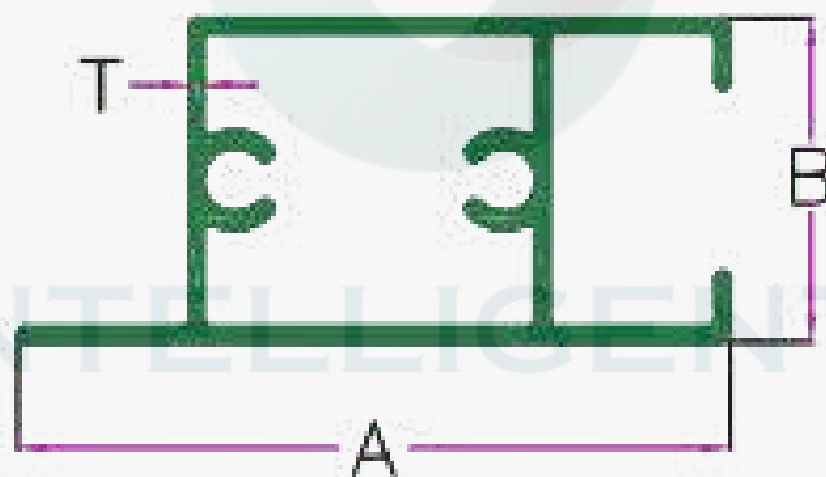

TOP BOTTOM SINGLE LEG

S. No.	Sec. No.	A IN mm.	B IN mm.	T IN mm.	Wt. (KG/12')
1	1851	40.00	18.00	1.00	1.200-1.300
2	1852	40.00	18.00	1.20	1.400-1.500
3	1853	40.00	18.00	1.40	1.600-1.800
4	1854	40.00	18.00	1.50	2.000-2.200

SLIDING SECTION BOMBAY SLIDING



INTELLIGENT
ALUMINIUM
itswallpanel.com

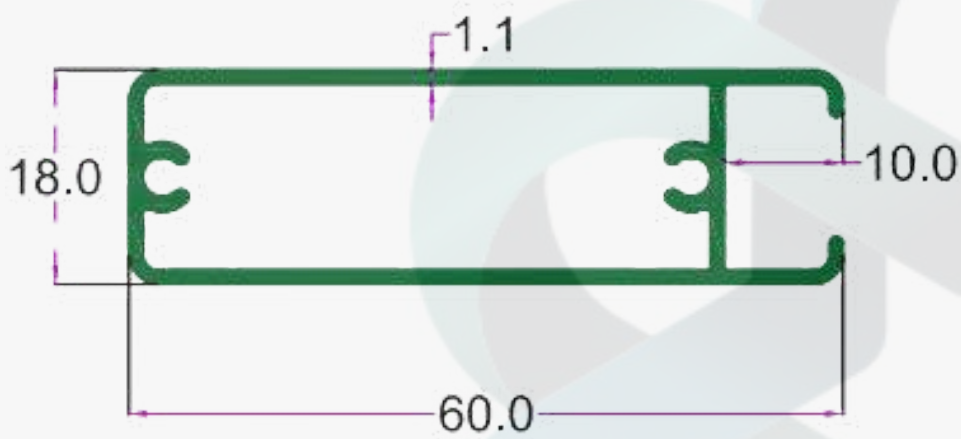

SEC. NO. 1993
WT. 2.250 TO 2.350 KG/12'

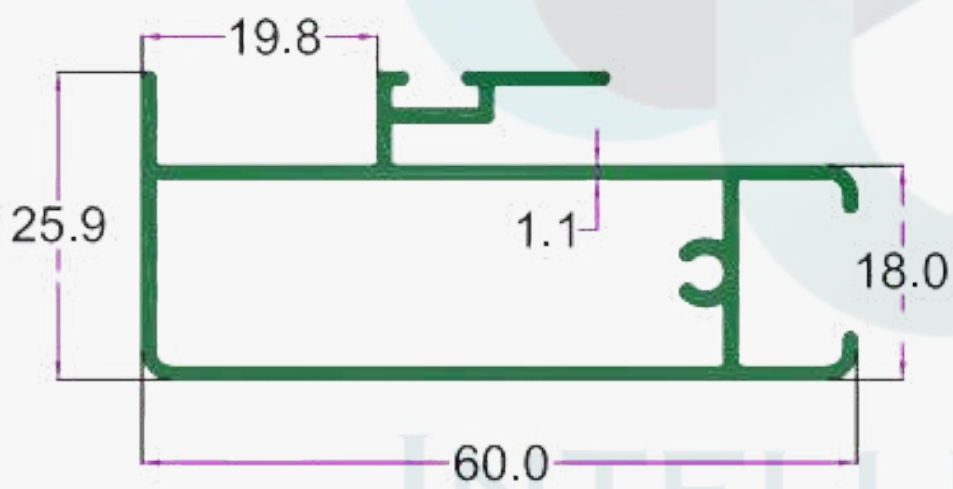

SEC. NO. 1995
WT. 3.150 TO 3.250 KG/15'

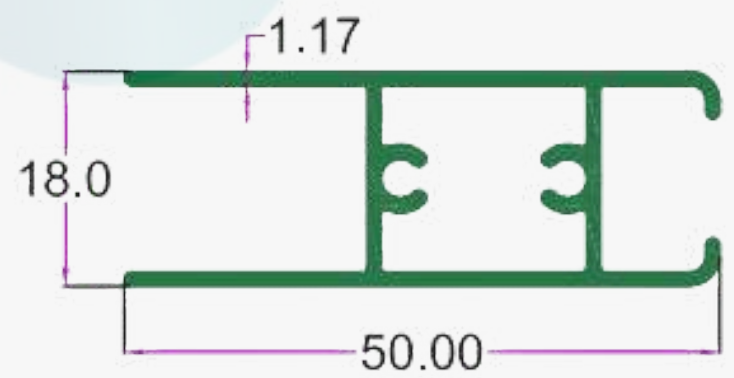

SEC. NO. 1997
WT. 2.000 TO 2.200 KG/15'

itswallpanel.com

SLIDING SECTION BOMBAY SLIDING



INTELLIGENT
ALUMINIUM
itswallpanel.com

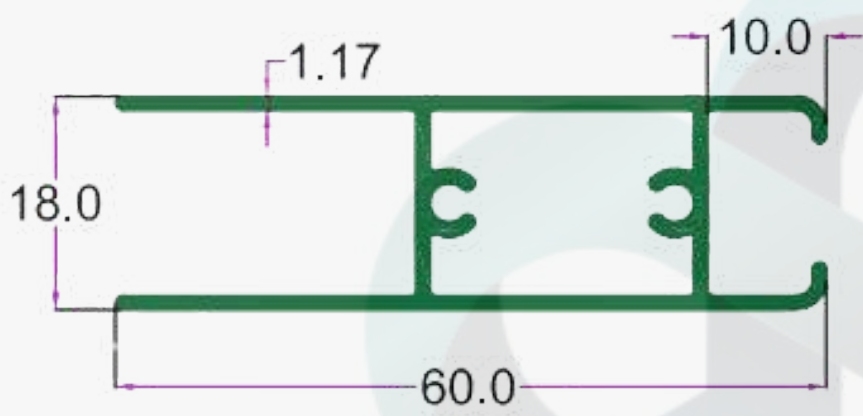

SEC. NO. 1994
WT. 2.700 TO 2.850 KG/15'

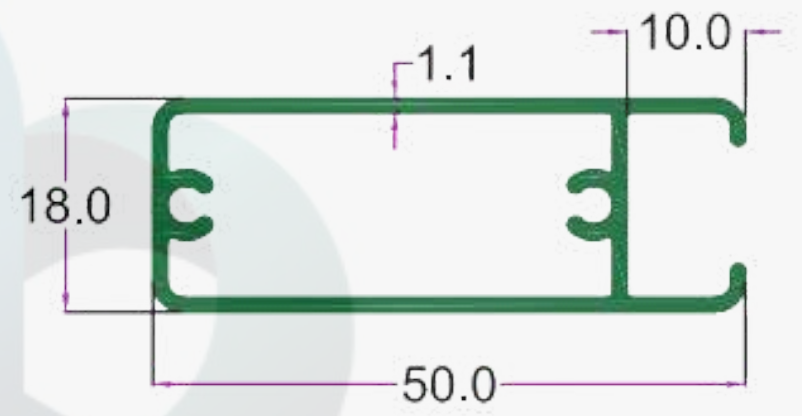

SEC. NO. 1996
WT. 2.000 TO 2.150 KG/15'

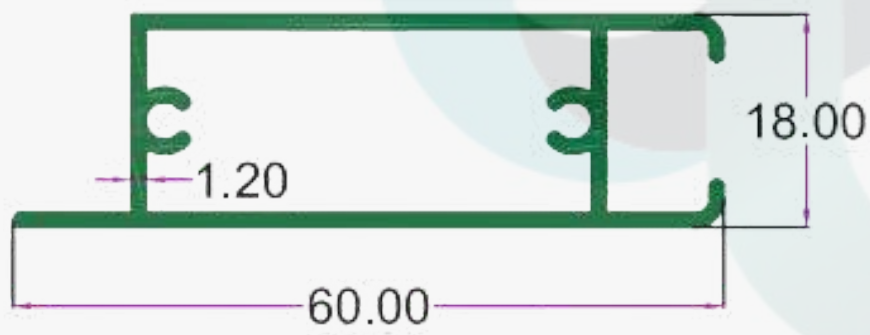

SEC. NO. 1999
WT. 2.390 TO 2.500 KG/15'

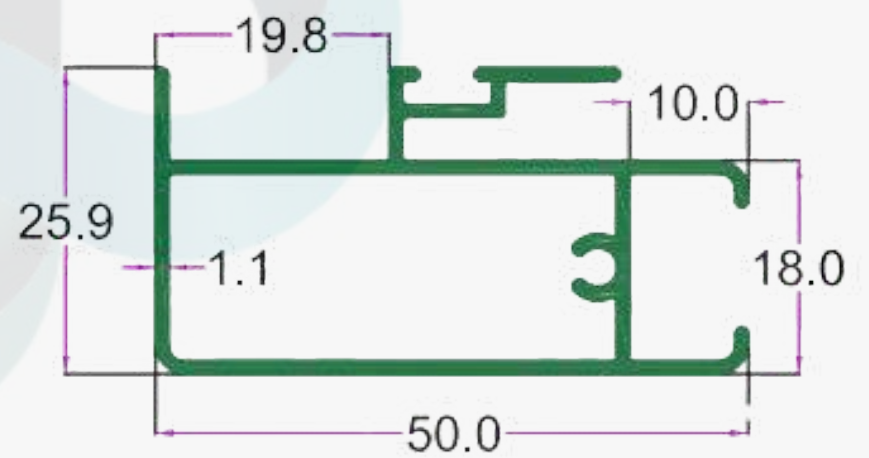

SEC. NO. 1998
WT. 2.450 TO 2.550 KG/15'

ALUMINIUM

itswallpanel.com

SLIDING SECTION BOMBAY SLIDING



INTELLIGENT
ALUMINIUM
itswallpanel.com

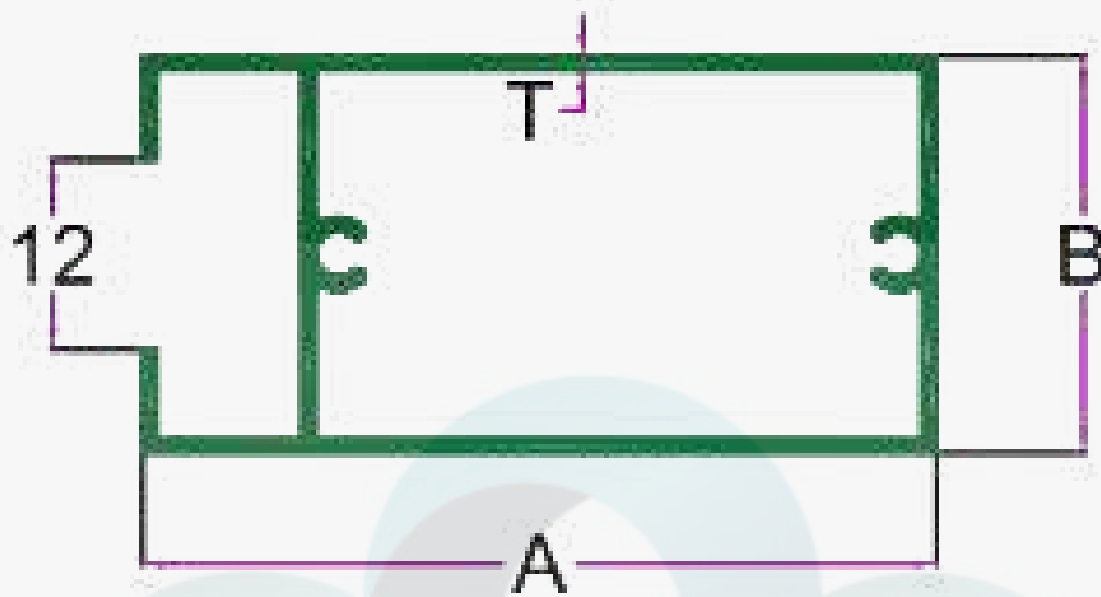

1" HANDLE

S.No.	Section No.	A IN mm.	B IN mm.	T IN mm.	Weight. (KG/15')
1	1981	50.00	25.00	0.90	1.900-2.200
2	1981	50.00	25.00	1.25	2.150-2.300
3	1981	50.00	25.00	1.40	2.250-2.400
4	1981	50.00	25.00	1.70	2.900-3.200
6	1981	50.00	25.00	2.10	3.700-4.000
7	1982	50.00	25.00	1.00	2.000-2.200

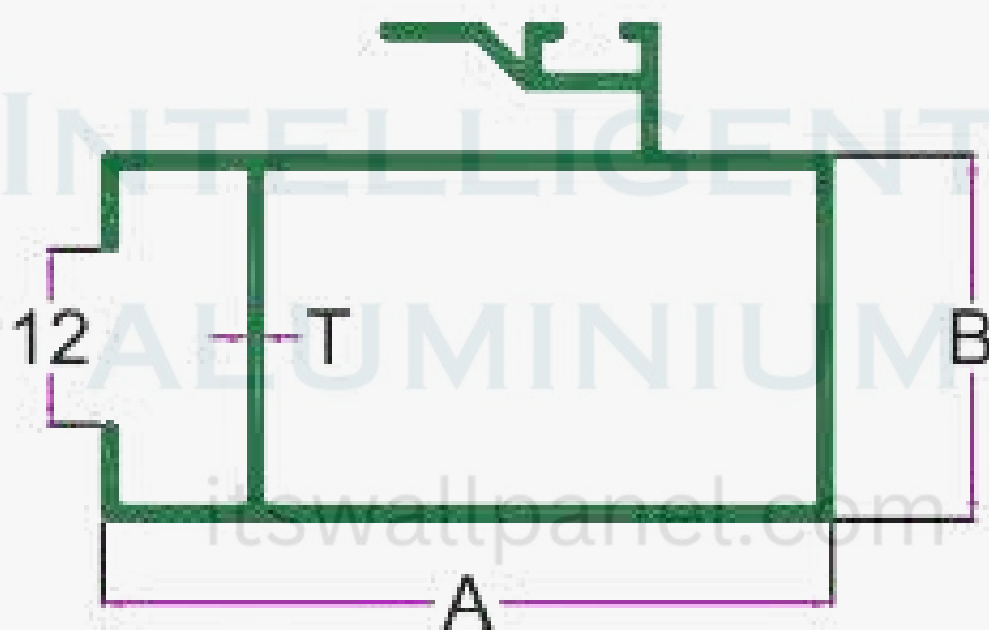

1" INTERLOCK

S.No.	Section No.	A IN mm.	B IN mm.	T IN mm.	Weight. (KG/15')
1	1983	50.00	25.00	1.00	2.600-2.800
2	1983	50.00	25.00	1.40	3.200-3.400(12')

SLIDING SECTION BOMBAY SLIDING



INTELLIGENT
ALUMINIUM
itswallpanel.com

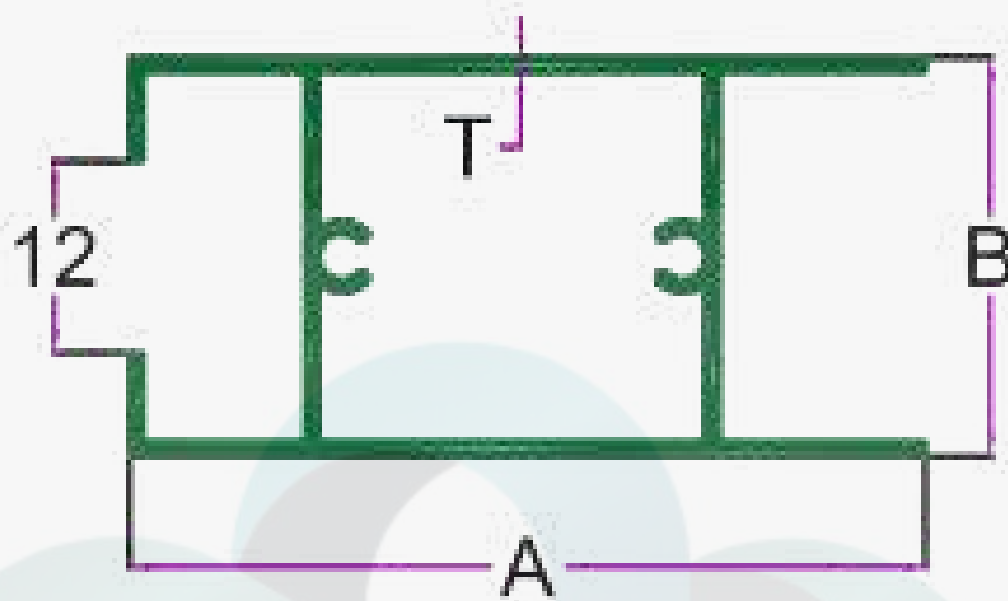

1" TOP BOTTOM

S.No.	Section No.	A IN mm.	B IN mm.	T IN mm.	Weight. (KG/15')
1	1984	50.0	25.00	1.30	2.150-2.300
2	1984	50.0	25.00	1.40	2.250-2.400
3	1984	50.0	25.00	1.70	2.600-2.800
4	1984	50.0	25.00	1.20	1.780-2.000
5	1985	50.0	25.00	1.00	2.600-2.800

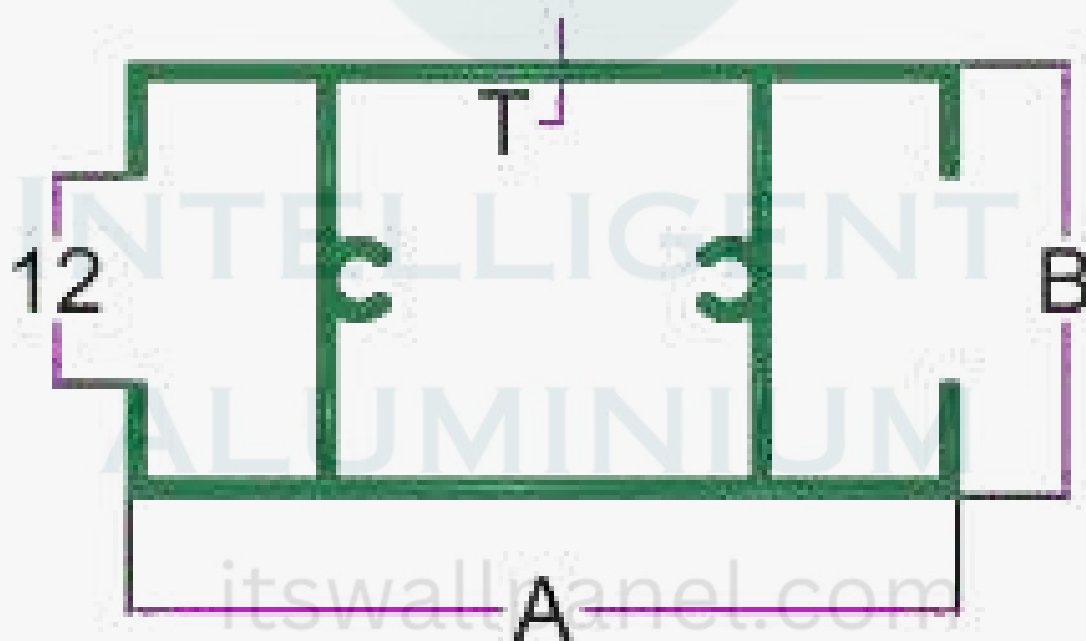

1" MATTING

S.No.	Section No.	A IN mm.	B IN mm.	T IN mm.	Weight. (KG/15')
1	1986	50.0	25.00	0.90	2.400-2.600

SLIDING SECTION BOMBAY SLIDING



INTELLIGENT
ALUMINIUM
itswallpanel.com

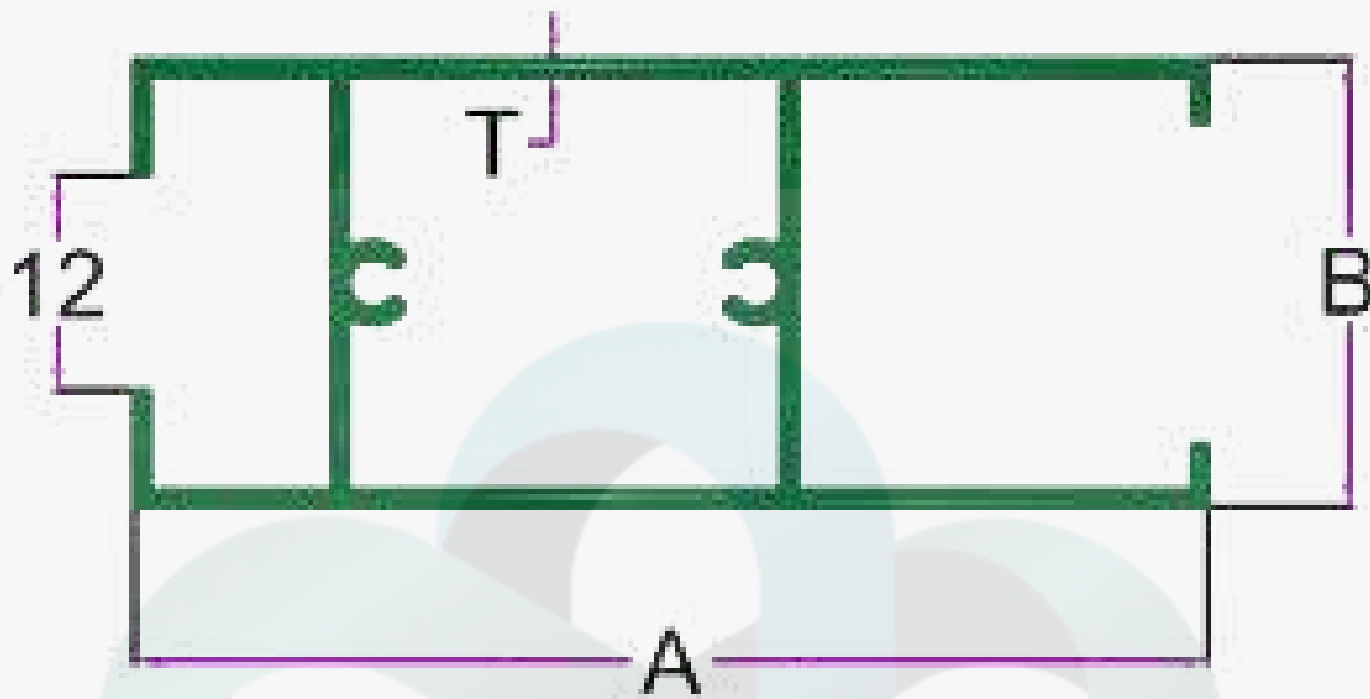

1" BEARING BOTTOM

S.No.	Section No.	A IN mm.	B IN mm.	T IN mm.	Weight. (KG/15')
1	1987	60.0	25.00	2.6	4.300-4.500
2	1987	60.0	25.00	1.3	2.400-2.600

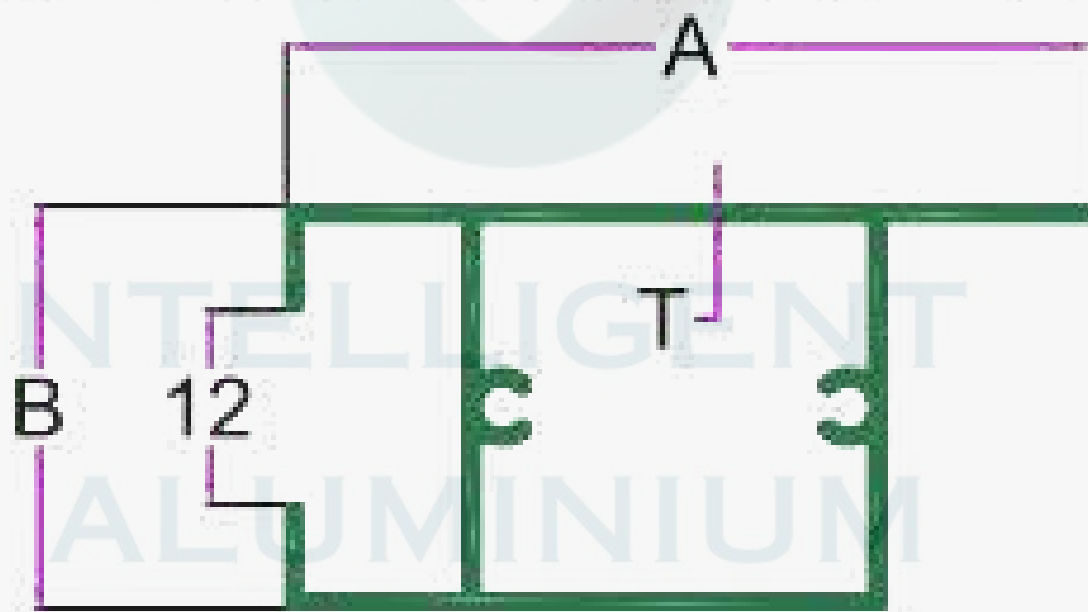

itswallpanel.com

1" TOP BOTTOM SINGLE LEG

S.No.	Section No.	A IN mm.	B IN mm.	T IN mm.	Weight. (KG/15')
1	1988	50.0	25.00	1.20	1.780-1.980
2	1988	50.0	25.00	1.50	2.400-2.600



INTELLIGENT
ALUMINIUM
itswallpanel.com

SLIDING SECTION BOMBAY SLIDING 25 MM

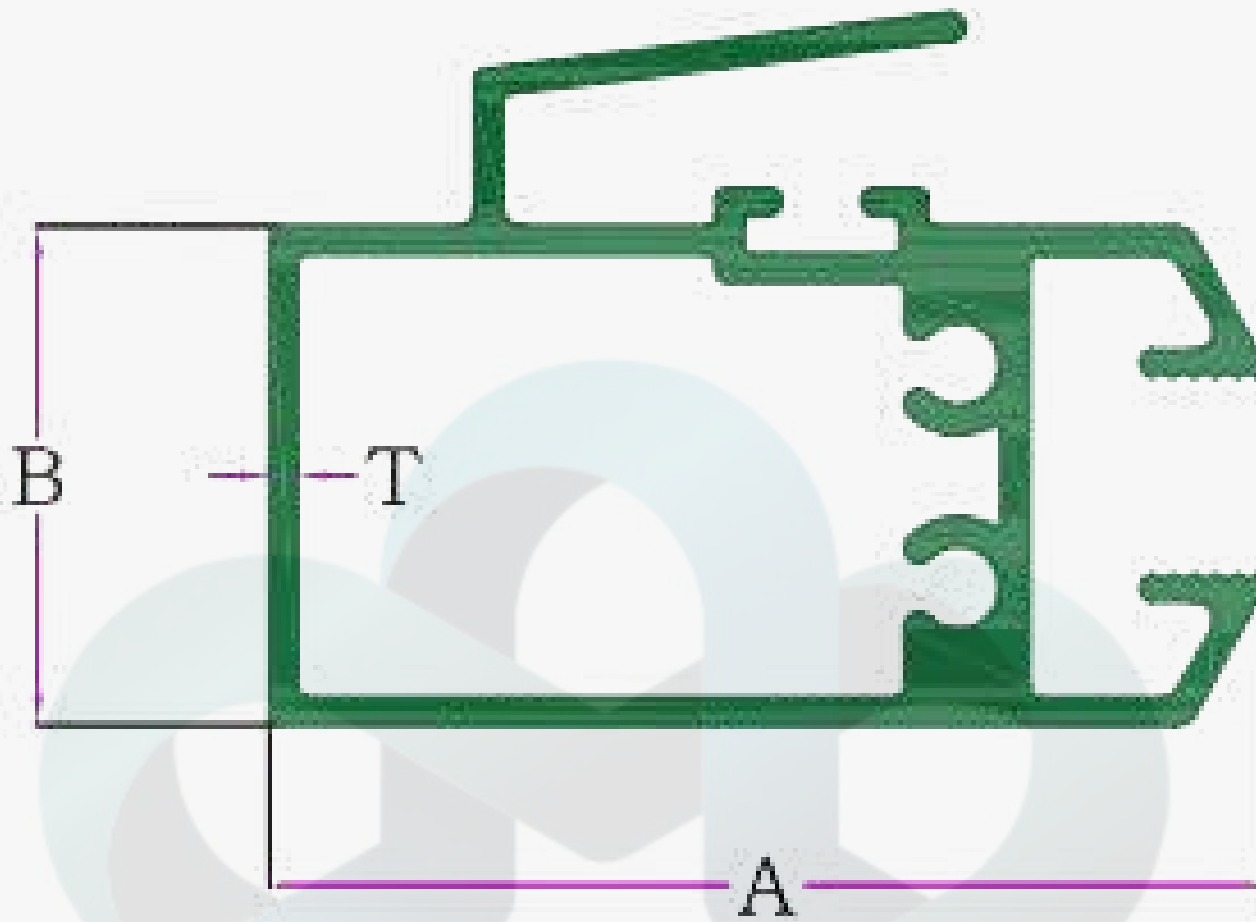

25 MM. INTER LOCK

S.No.	Section No.	A in mm.	B in mm.	T in mm.	Weight (KG/15')
1	1921	50.80	25.40	1.40	3.500-4.200
2	1922	50.80	25.40	1.70	4.300-5.500

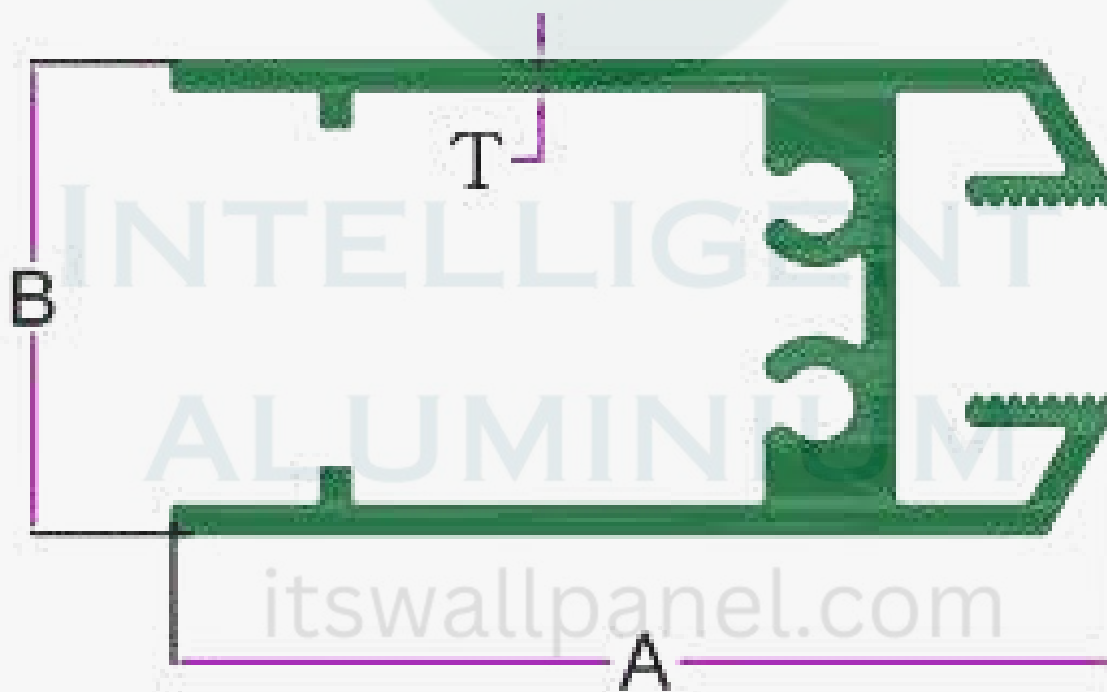

25 MM. TOP BOTTOM

S.No.	Section No.	A in mm.	B in mm.	T in mm.	Weight (KG/15')
1	1925	69.00	25.40	1.55	3.500-4.200
2	1926	69.00	25.40	1.80	4.300-5.500

SLIDING SECTION BOMBAY SLIDING 25 MM



INTELLIGENT
ALUMINIUM
itswallpanel.com



25 MM. HANDLE SECTION

Sl No.	Section No.	A in mm.	B in mm.	T in mm.	Weight (KG/15')
1	1930	50.80	25.40	1.50	4.000-4.300
2	1931	50.80	25.40	2.00	4.300-5.500

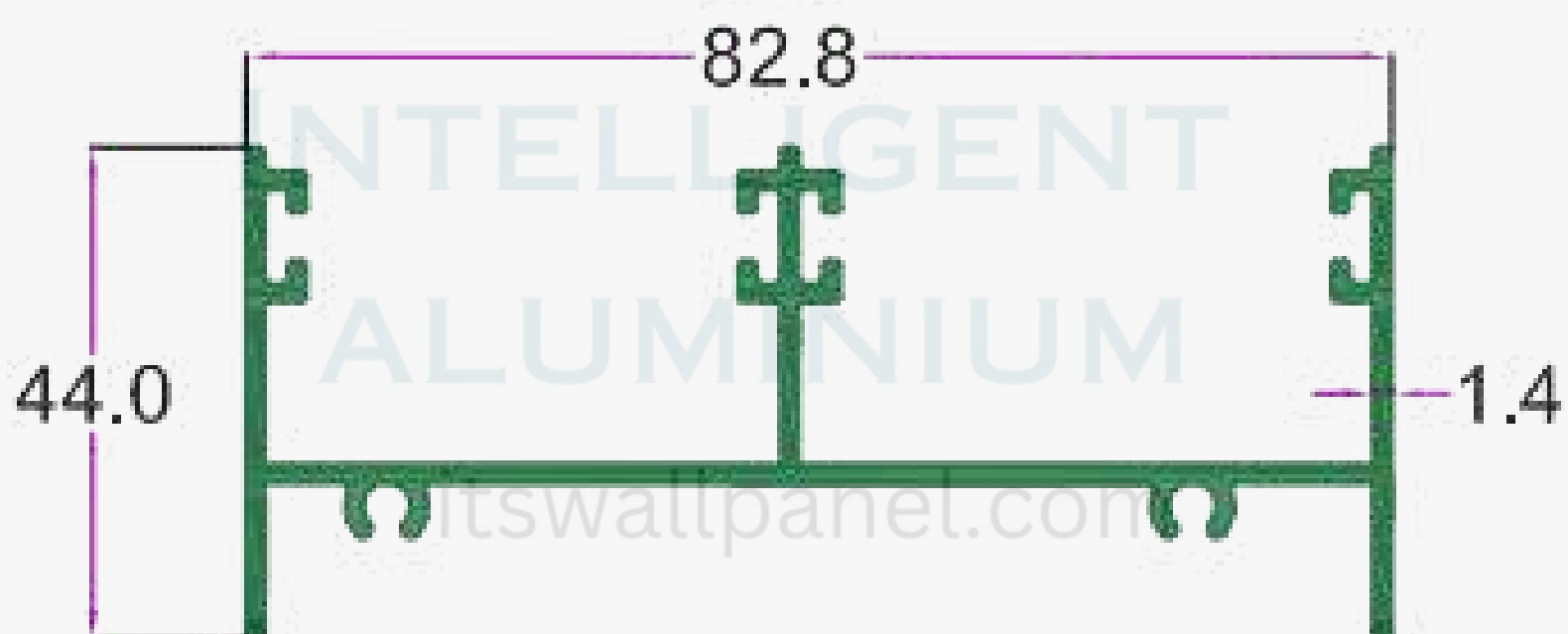

SEC. NO. 1932

WT. 5.950 TO 6.200 KG/15'

WT. 5.000 TO 6.500 KG/15'

SLIDING SECTION BOMBAY SLIDING 25 MM



INTELLIGENT
ALUMINIUM
itswallpanel.com

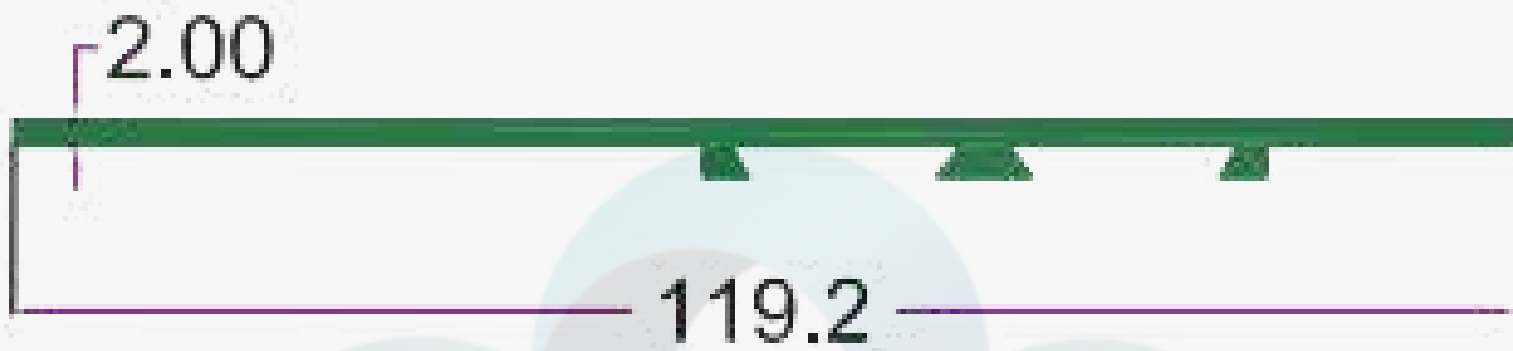

SEC. NO. 1936

WT. 2.800 TO 3.000 KG/15'



SEC. NO. 1935

WT. 9.550 TO 9.700 KG/15'

SLIDING SECTION BOMBAY SLIDING 25 MM



INTELLIGENT
ALUMINIUM
itswallpanel.com

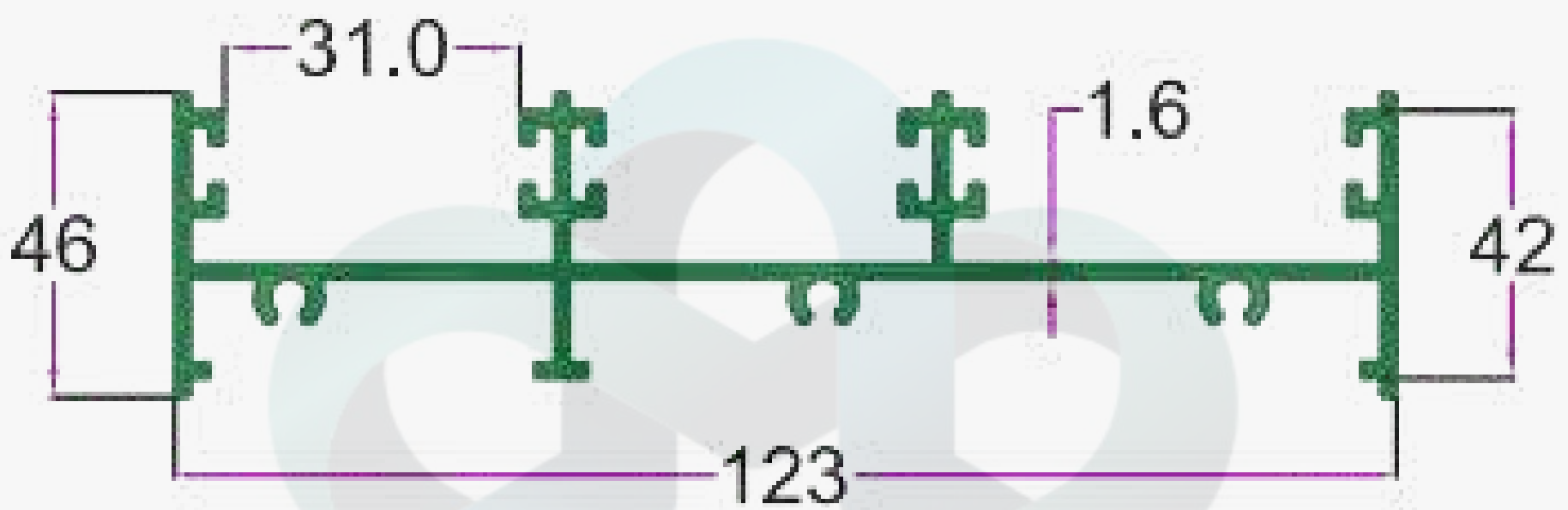

SEC. NO. 1933

WT. 7.800 TO 8.000 KG/15'



SEC. NO. 1934

WT. 6.000 TO 6.500 KG/15'

SLIDING SECTION BOMBAY SLIDING



INTELLIGENT
ALUMINIUM
itswallpanel.com

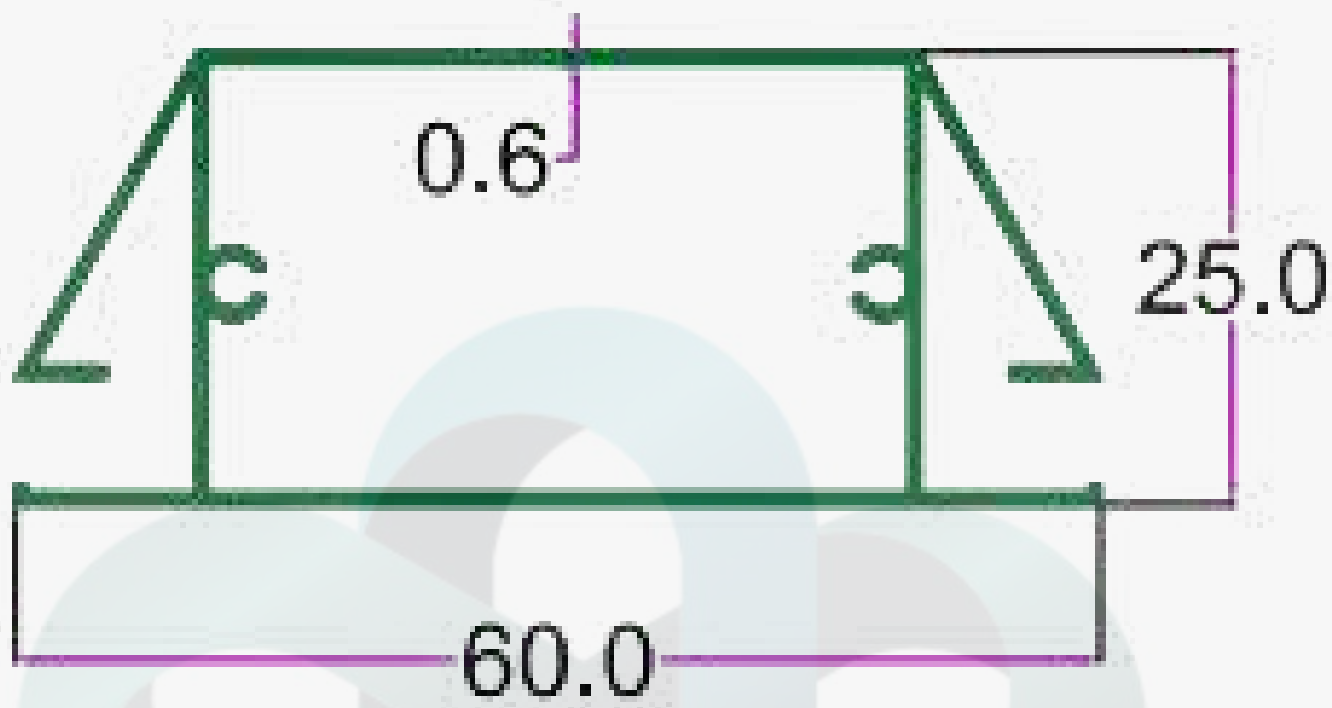

SEC. NO. 3043

WT. 1.250 TO 1.400 KG/12'

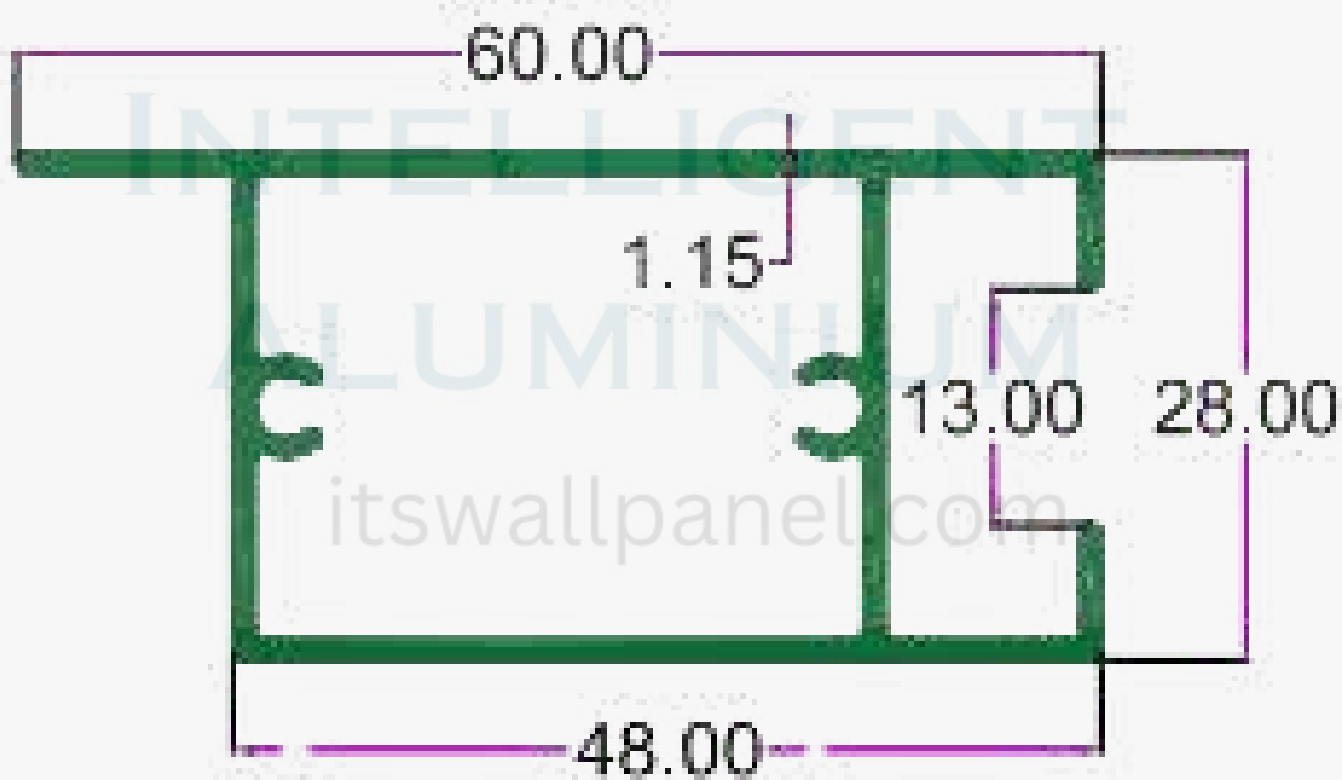

SEC. NO. 4312

WT. 2.700 TO 2.900 KG/12'

SLIDING SECTION BOMBAY SLIDING



INTELLIGENT
ALUMINIUM
itswallpanel.com

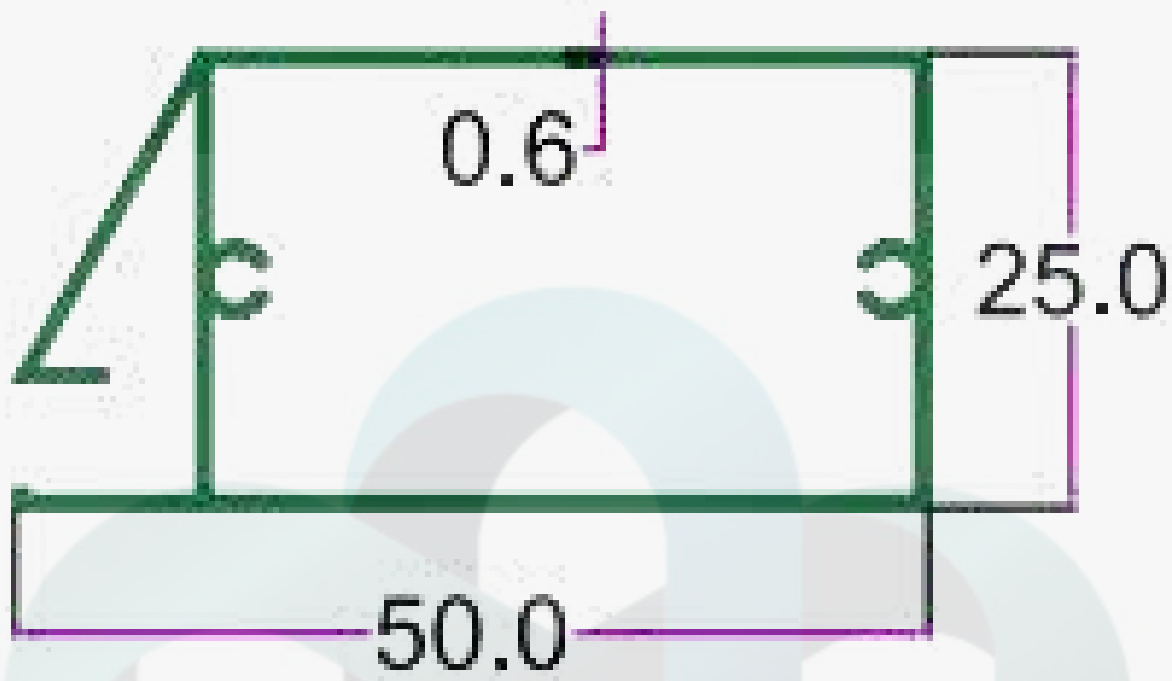

SEC. NO. 3044

WT. 1.040 TO 1.200 KG/12'

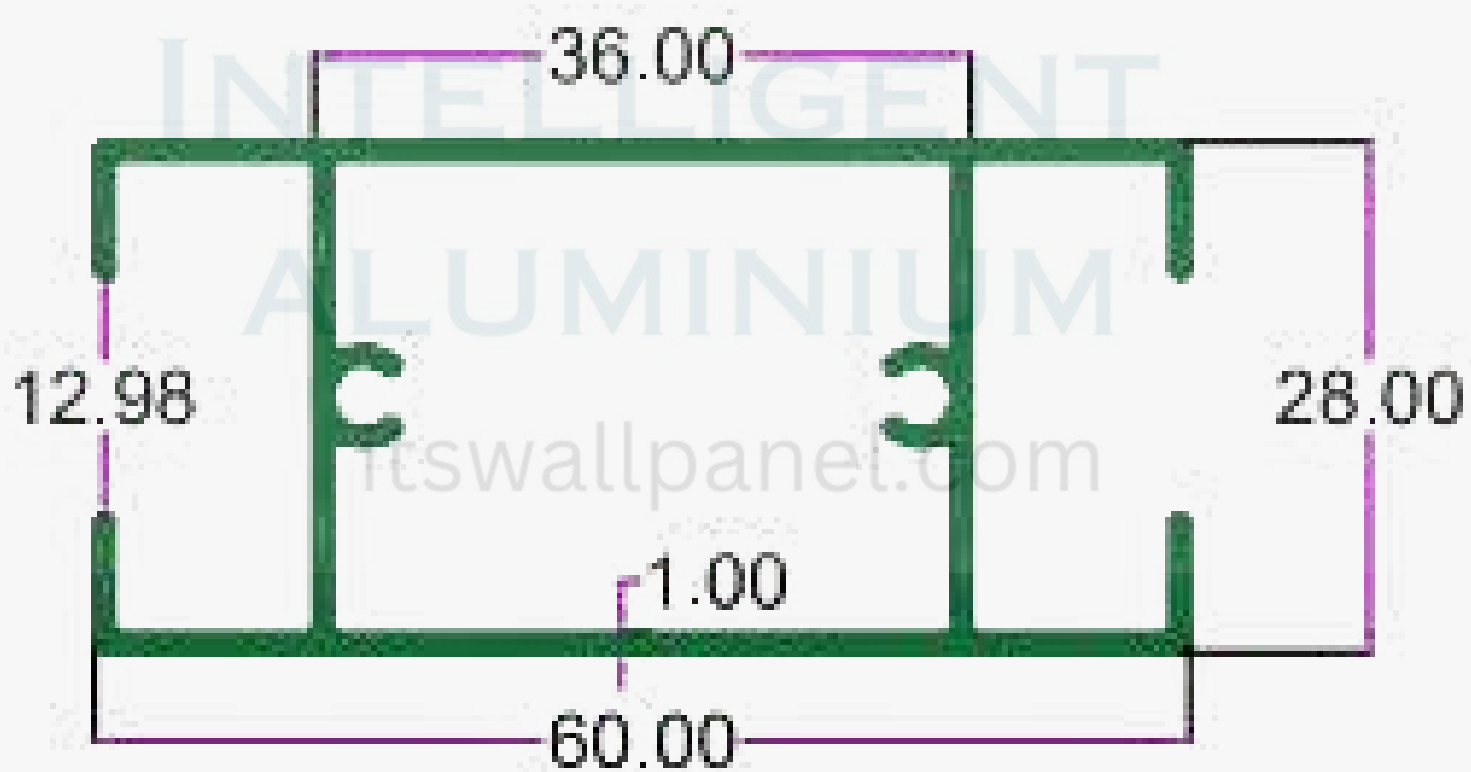

SEC. NO. 4310

WT. 2.700 TO 2.900 KG/12'

SLIDING SECTION BOMBAY SLIDING



INTELLIGENT
ALUMINIUM
itswallpanel.com

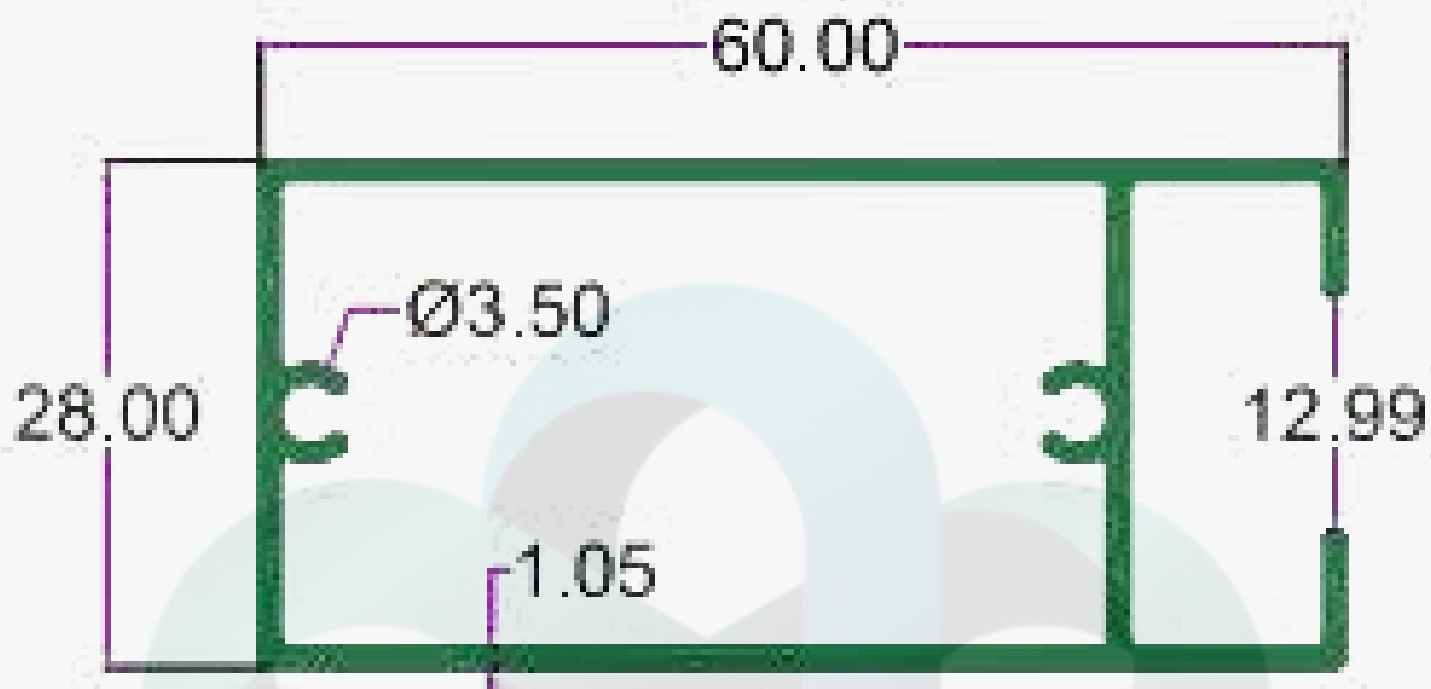

SEC.NO. 4309

WT. 2.700 TO 2.900 KG/12'

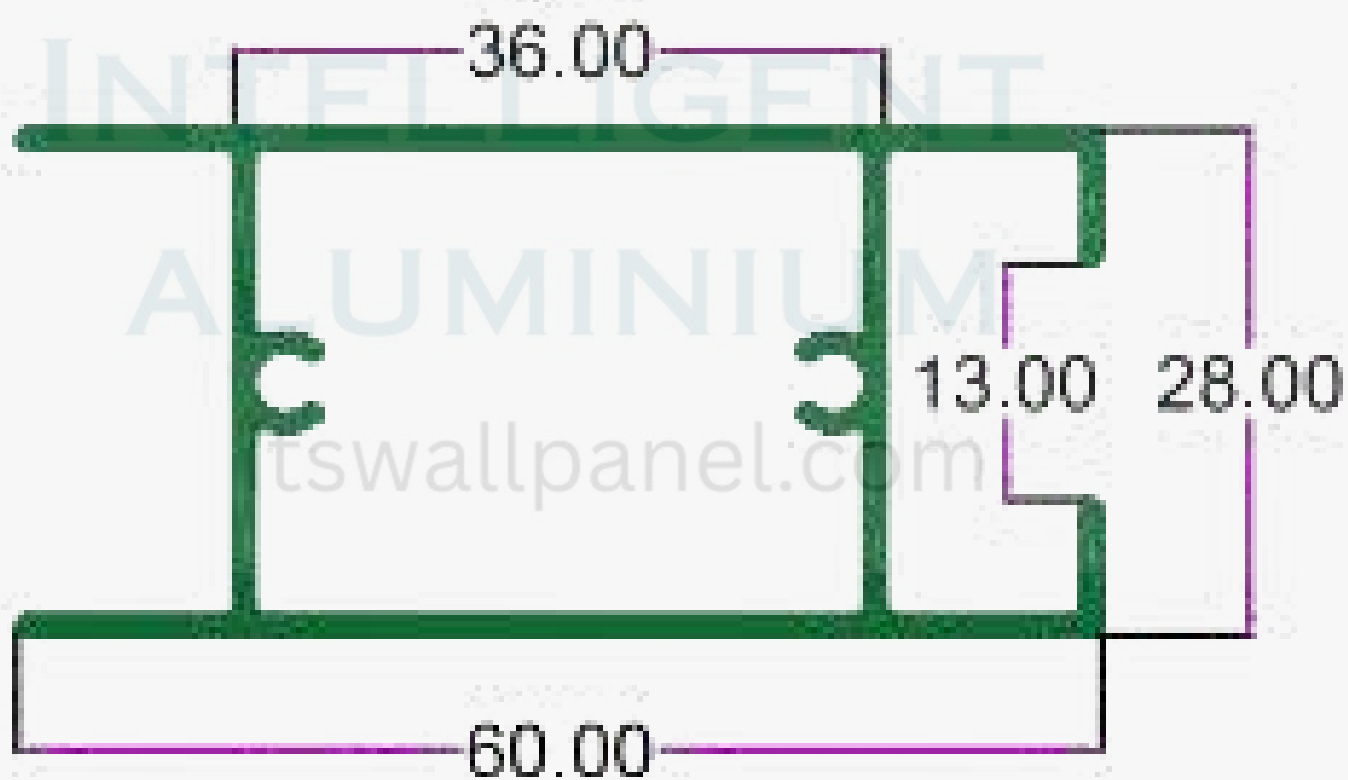

SEC.NO. 4311

WT. 2.700 TO 2.900 KG/12'

SLIDING SECTION BOMBAY SLIDING



INTELLIGENT
ALUMINIUM
itswallpanel.com

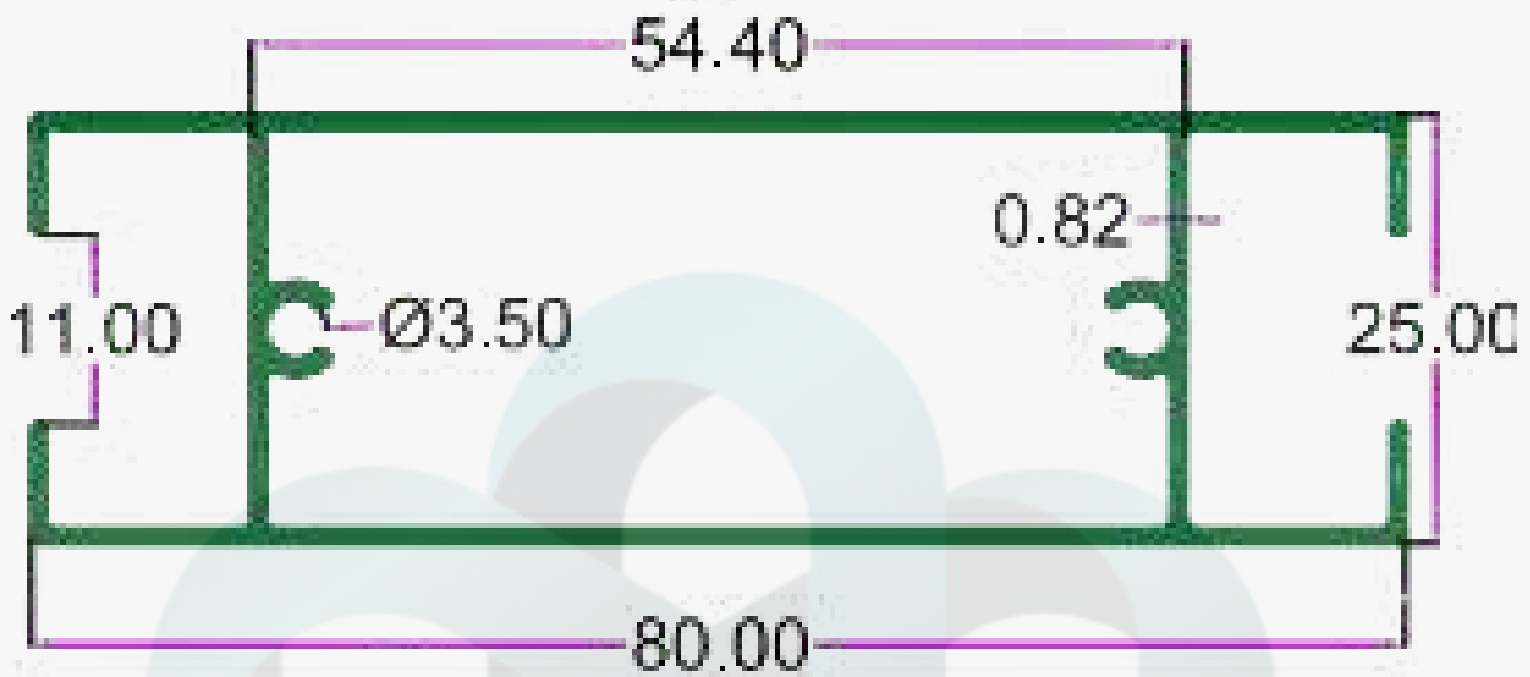

SEC.NO. 4279

WT. 2.700 TO 2.900 KG/16'

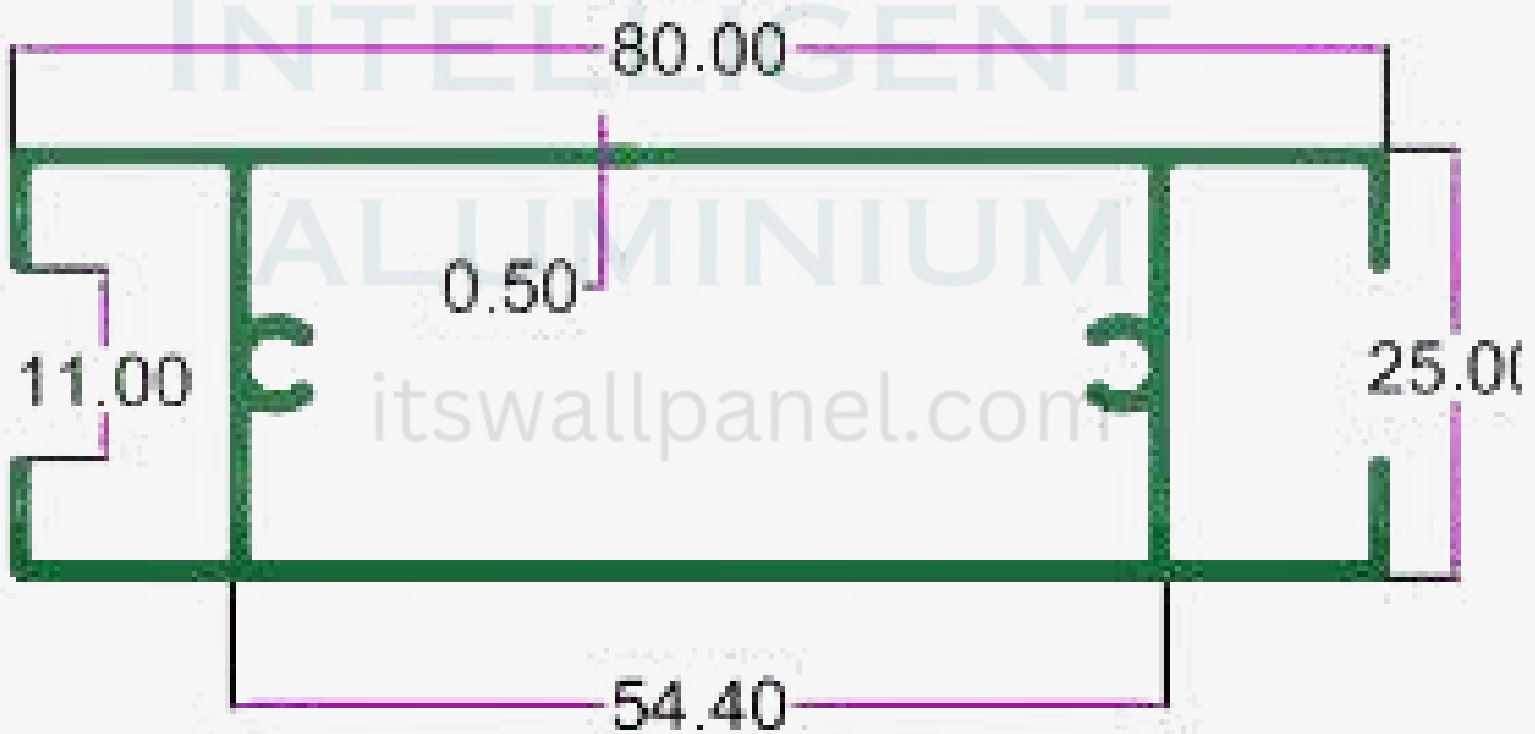

SEC.NO. 4286

WT. 2.000 TO 2.300 KG/16'

SLIDING SECTION BOMBAY SLIDING



INTELLIGENT
ALUMINIUM
itswallpanel.com

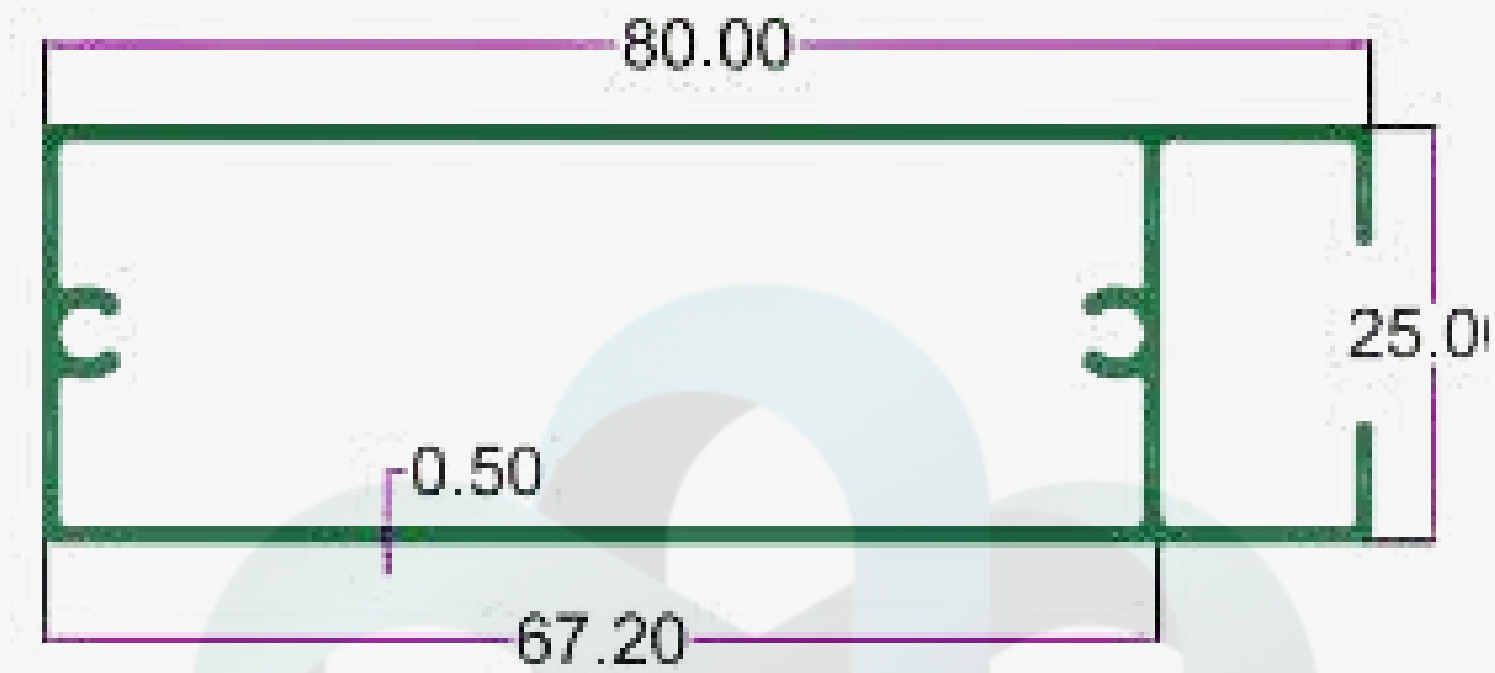

SEC.NO. 4285
WT. 2.000 TO 2.300 KG/16'

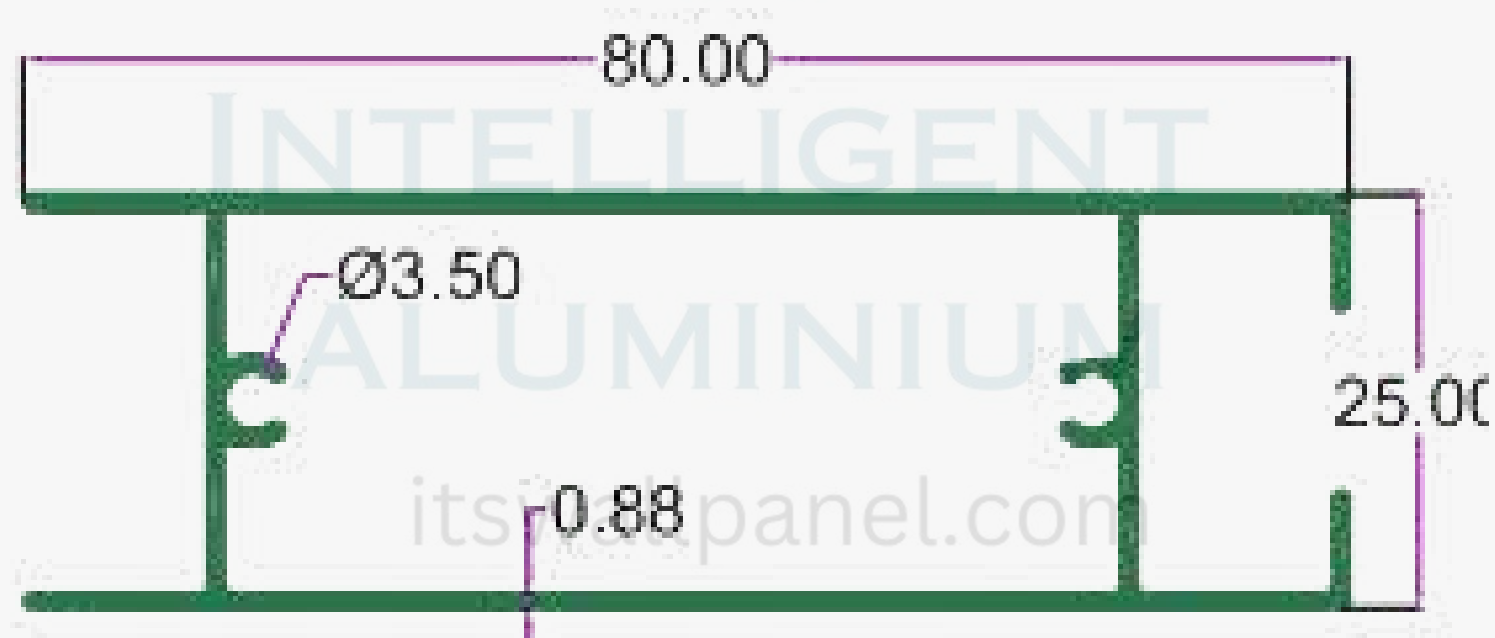

SEC.NO. 4281
WT. 2.700 TO 2.900 KG/16'

SLIDING SECTION BOMBAY SLIDING



INTELLIGENT
ALUMINIUM
itswallpanel.com

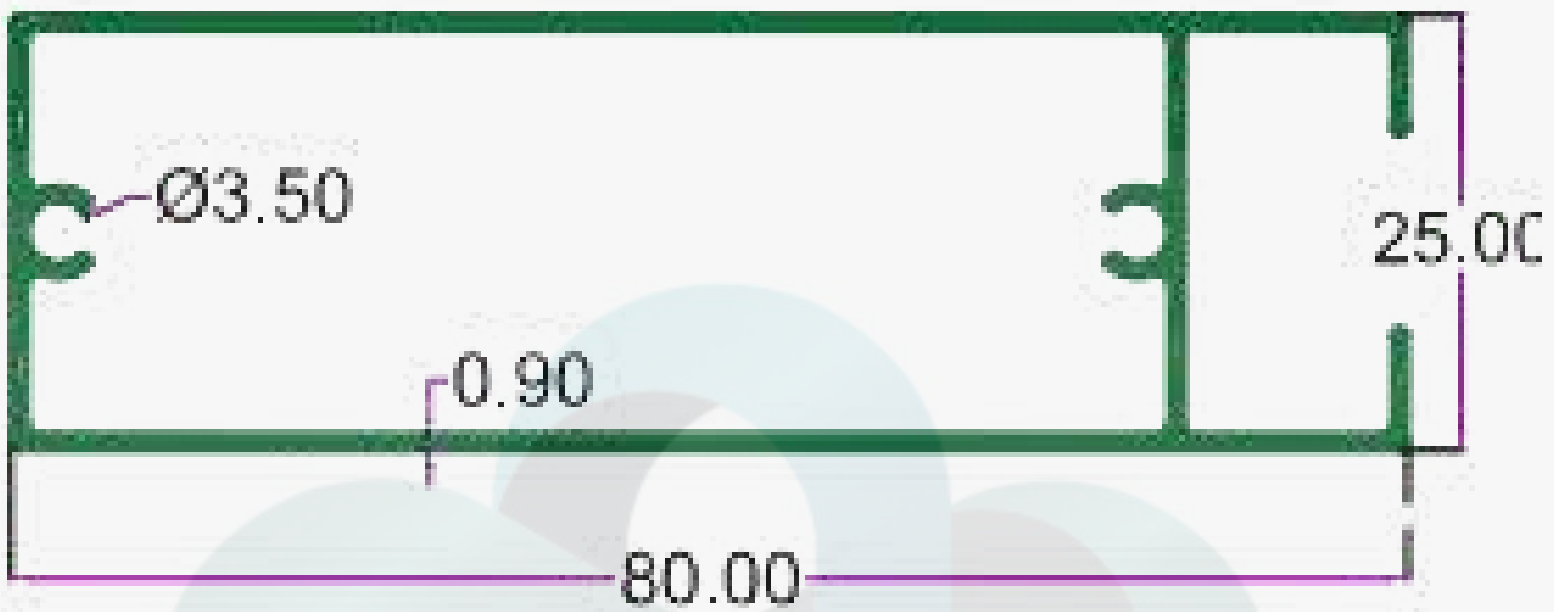

SEC.NO. 4280

WT. 2.700 TO 2.900 KG/16'

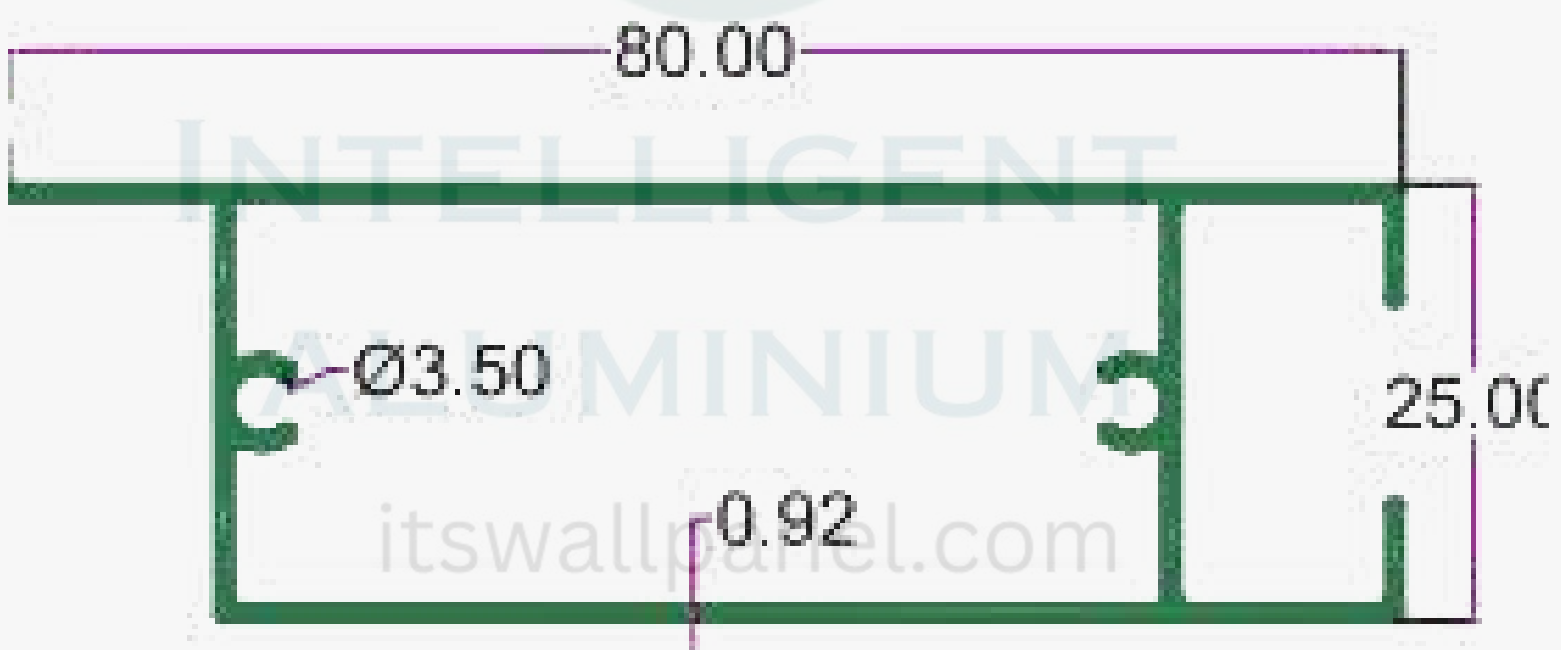

SEC.NO. 4282

WT. 2.700 TO 2.900 KG/16'

SLIDING SECTION BOMBAY SLIDING



INTELLIGENT
ALUMINIUM
itswallpanel.com

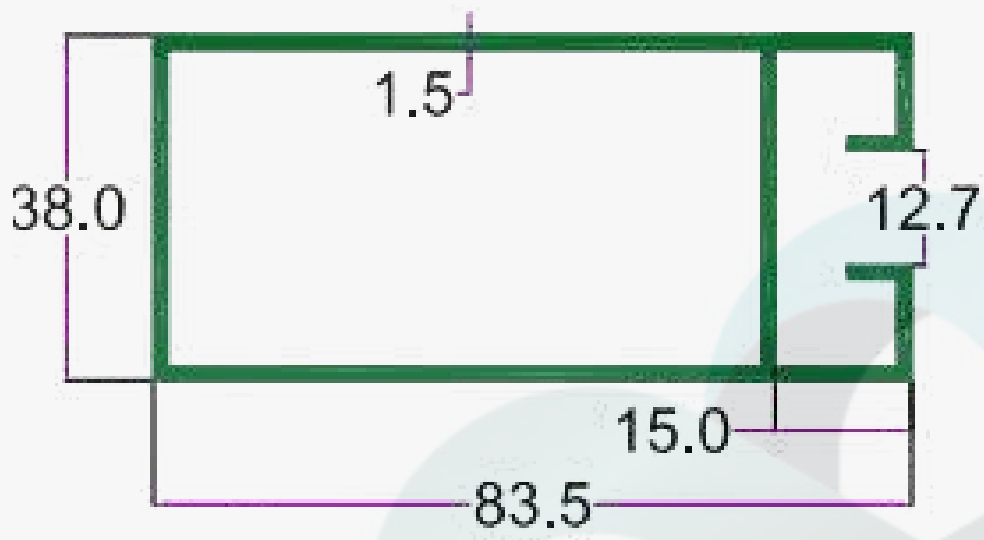

SEC.NO. 3301
WT. 4.950 TO 5.100 KG/15'

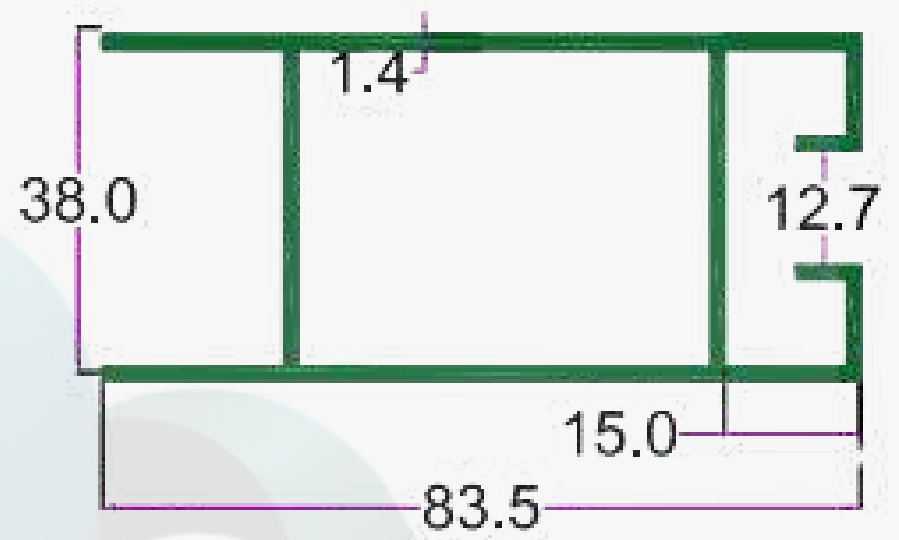

SEC.NO. 3302
WT. 3.772 TO 3.900 KG/12'

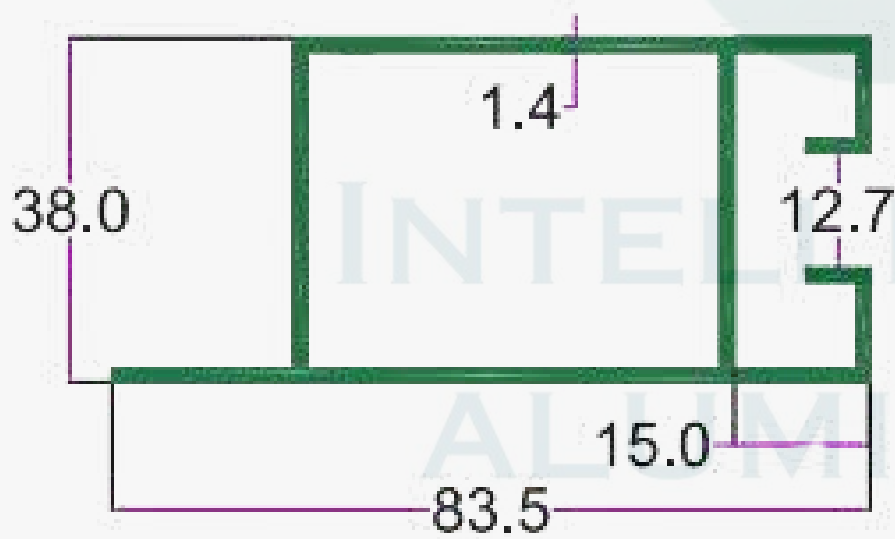

SEC.NO. 3304
WT. 3.400 TO 3.500 KG/12'

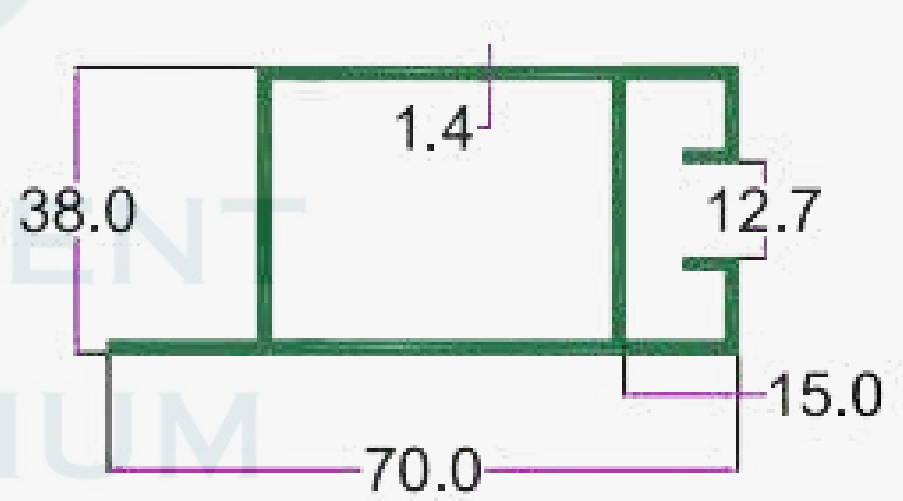

SEC.NO. 3305
WT. 3.027 TO 3.150 KG/12'

INTELLIGENT
ALUMINIUM
itswallpanel.com

SLIDING SECTION BOMBAY SLIDING



INTELLIGENT
ALUMINIUM
itswallpanel.com

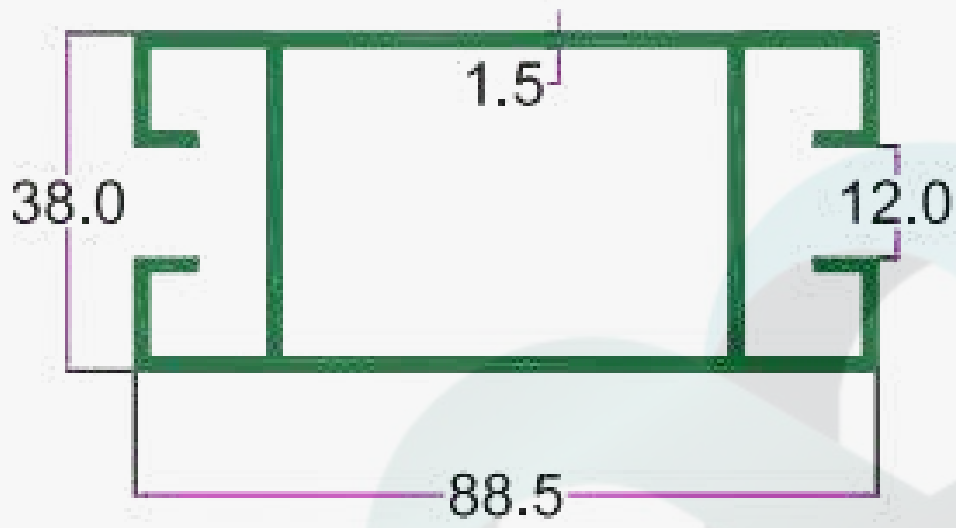

SEC.NO. 3303
WT. 4.430 TO 4.520 KG/12'

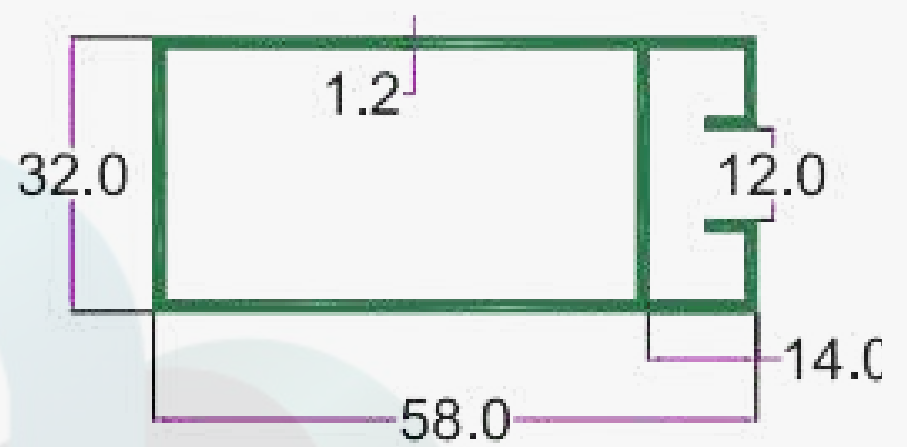

SEC.NO. 3306
WT. 2.410 TO 2.530 KG/12'

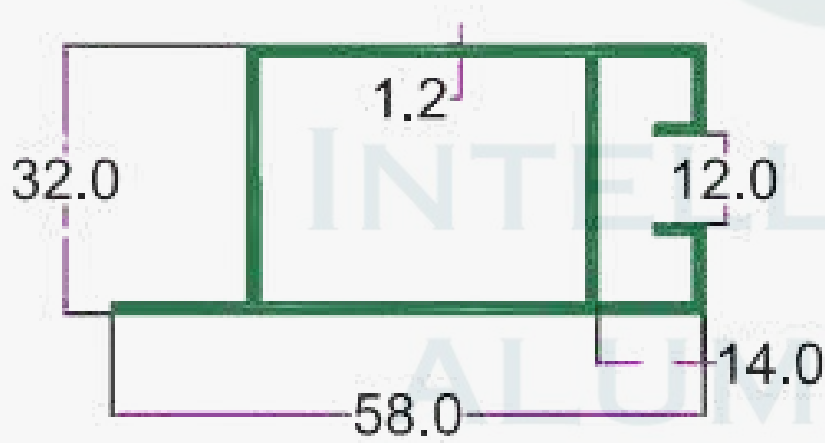

SEC.NO. 3307
WT. 2.260 TO 2.360 KG/12'

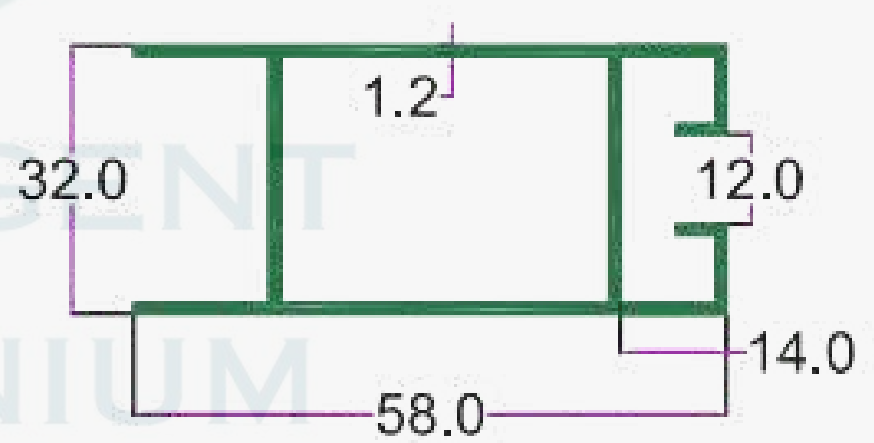

SEC.NO. 3308
WT. 2.390 TO 2.500 KG/12'

itswallpanel.com

SLIDING SERIES



INTELLIGENT
ALUMINIUM
itswallpanel.com

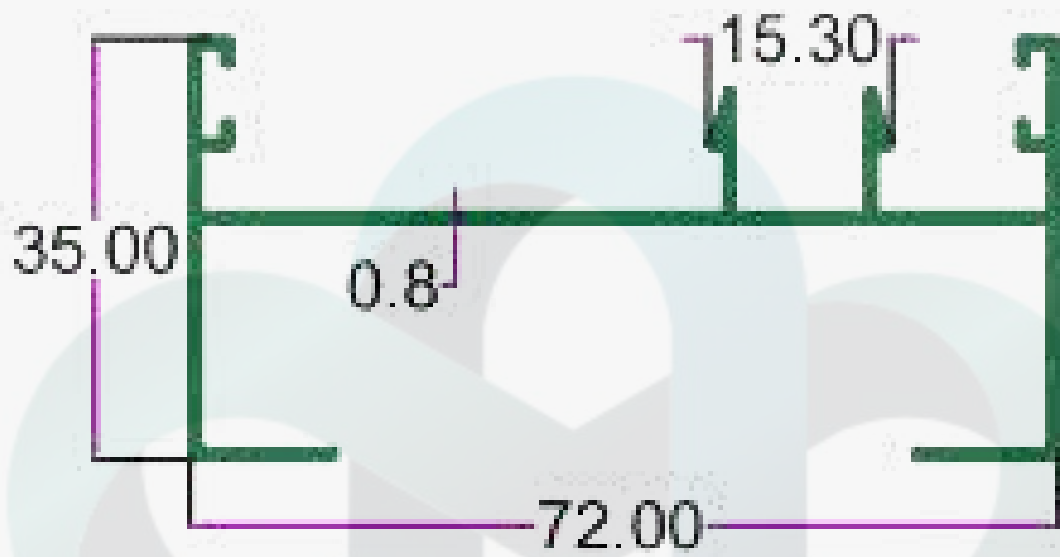

SEC. NO. 3473

WT. 1.600 TO 2.000 KG/12'

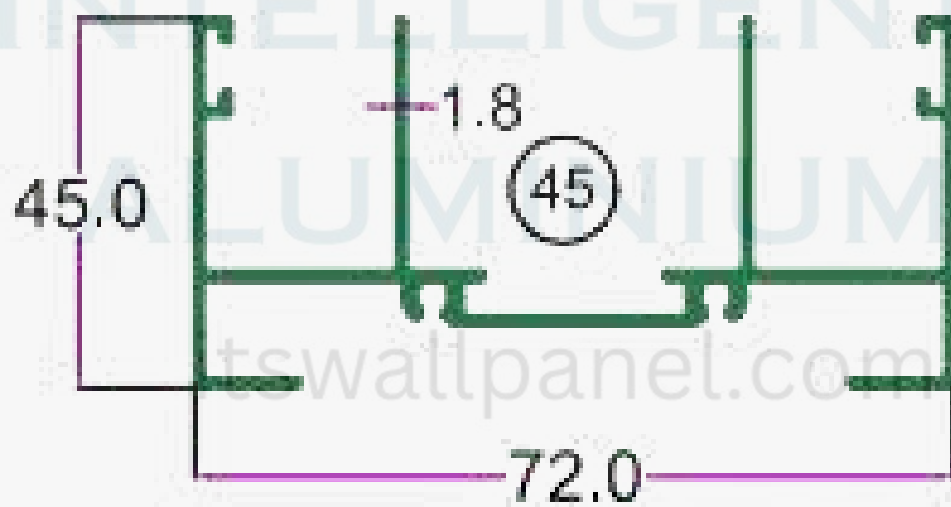

SEC. No. 3357

WT. 5.025 TO 5.180 KG/12'

SLIDING SERIES



INTELLIGENT
ALUMINIUM
itswallpanel.com

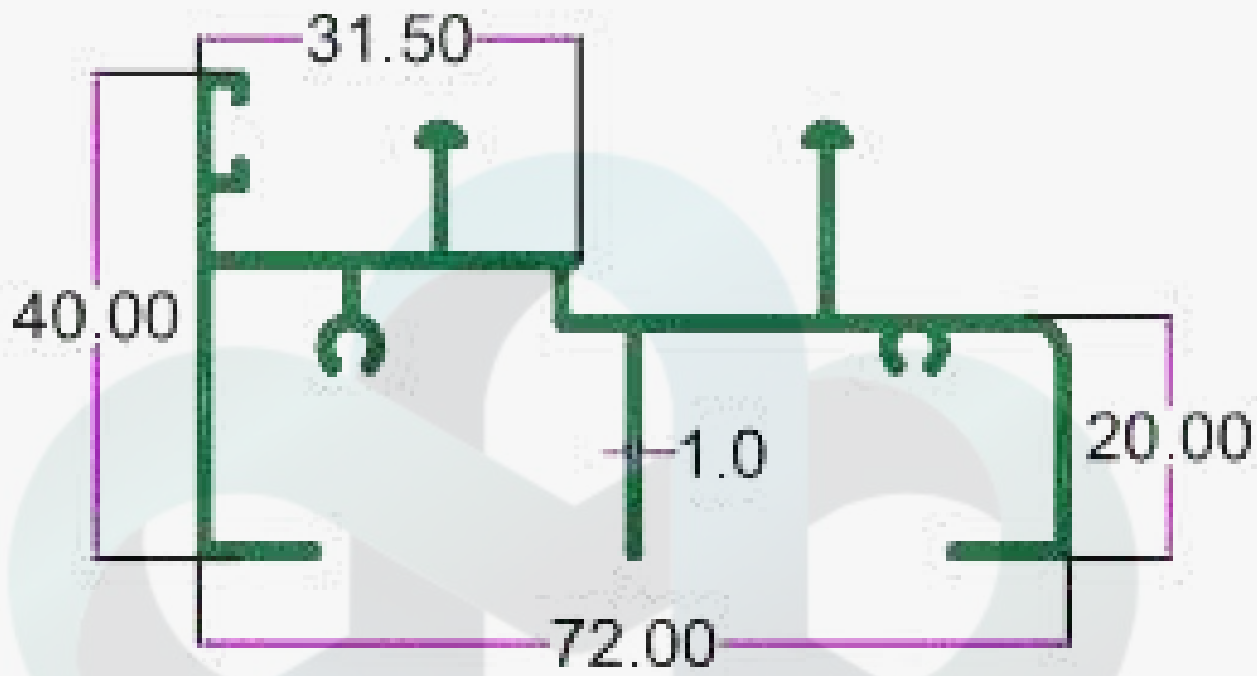

SEC. NO. 3471

WT. 2.380 TO 2.550 KG/12'

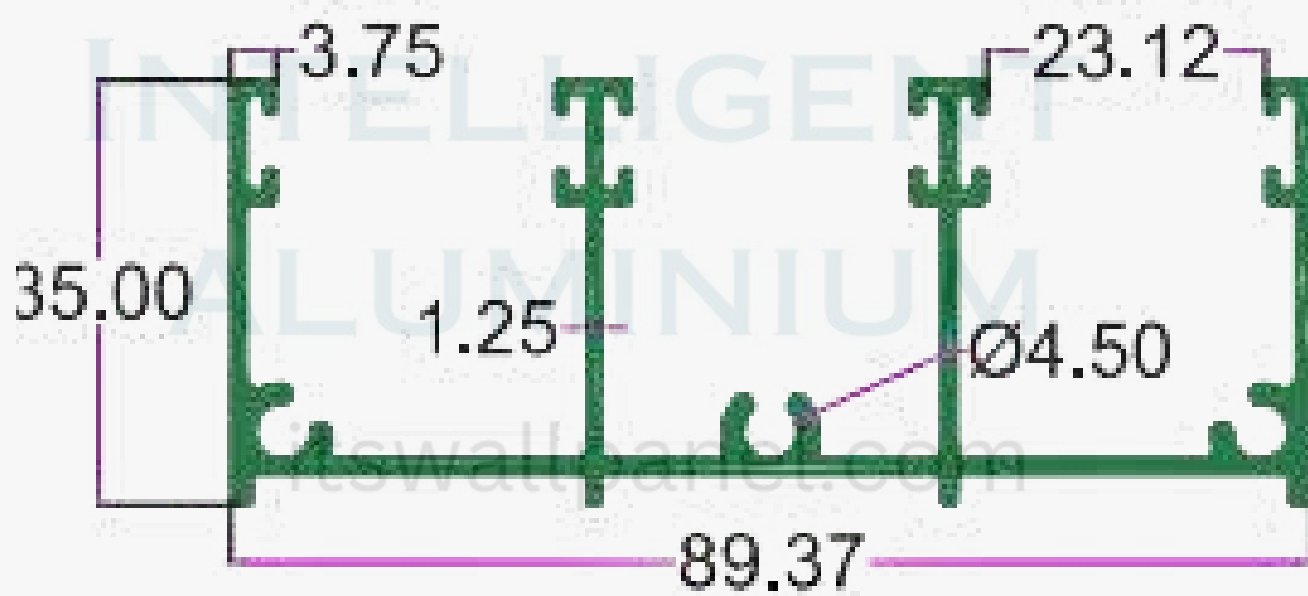

SEC. NO. 4815

WT. 3.900 TO 4.150 KG/12'

SLIDING SERIES



INTELLIGENT
ALUMINIUM
itswallpanel.com

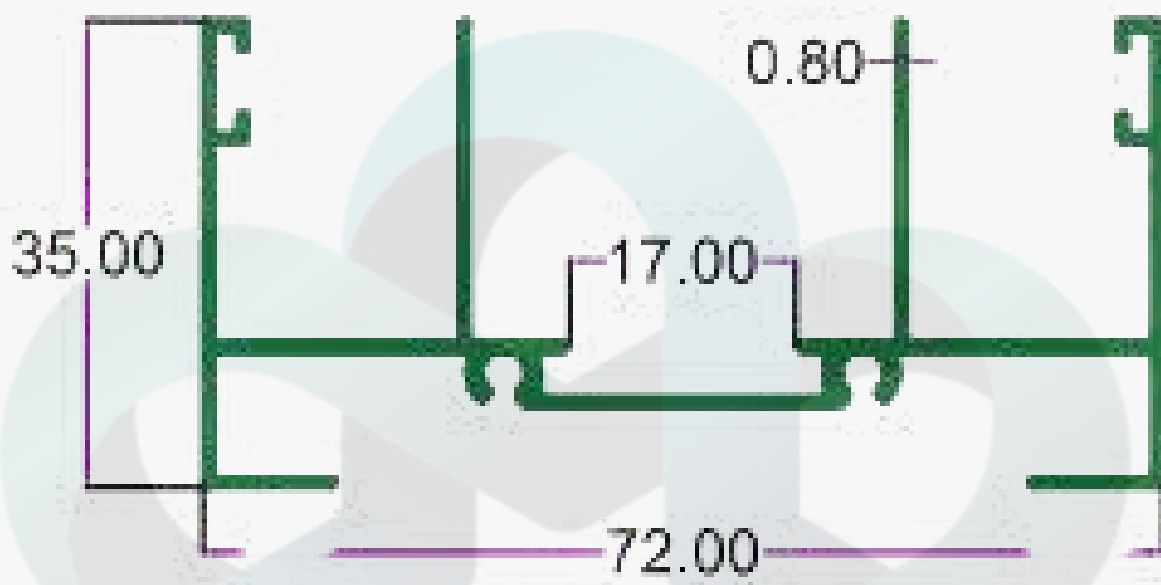

SEC. NO. 3472

WT. 2.000 TO 2.500 KG/12'

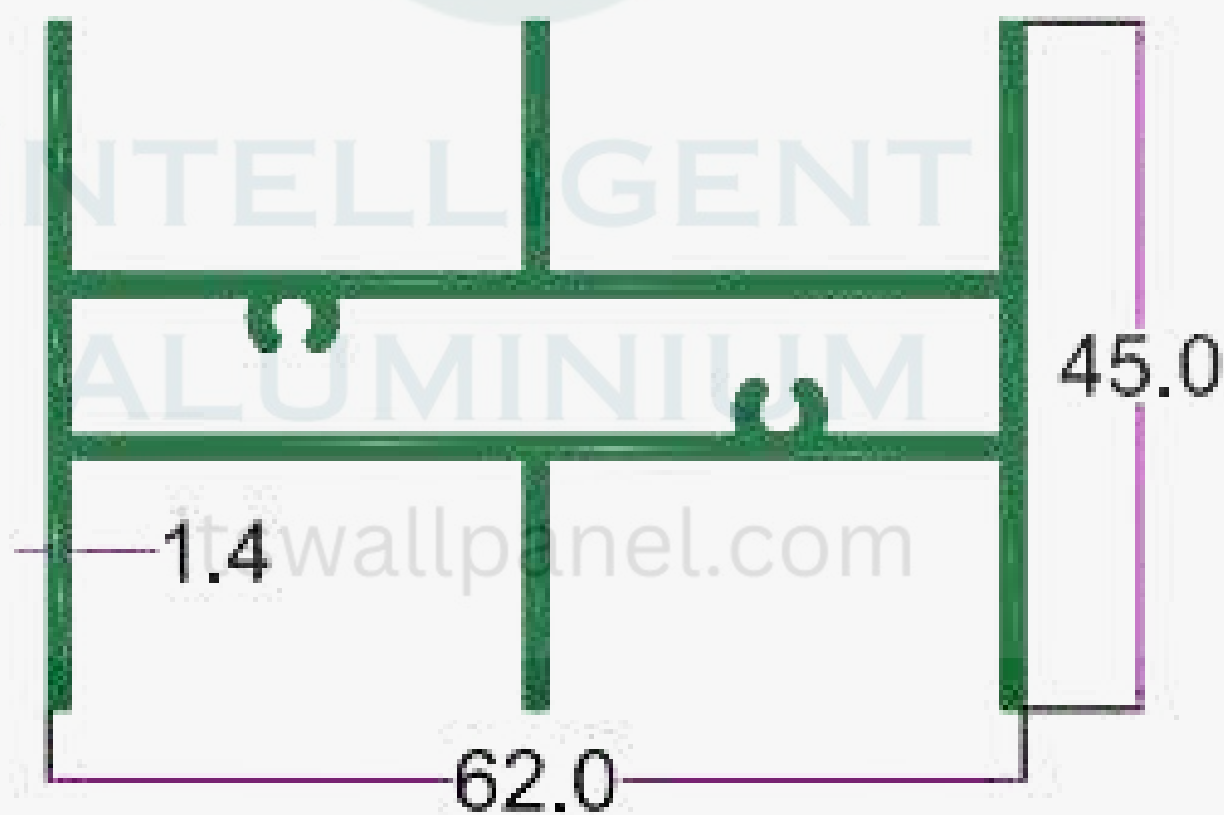

SEC. NO. 3507

WT. 3.400 TO 3.800 KG/12'

SLIDING SERIES



INTELLIGENT
ALUMINIUM
itswallpanel.com

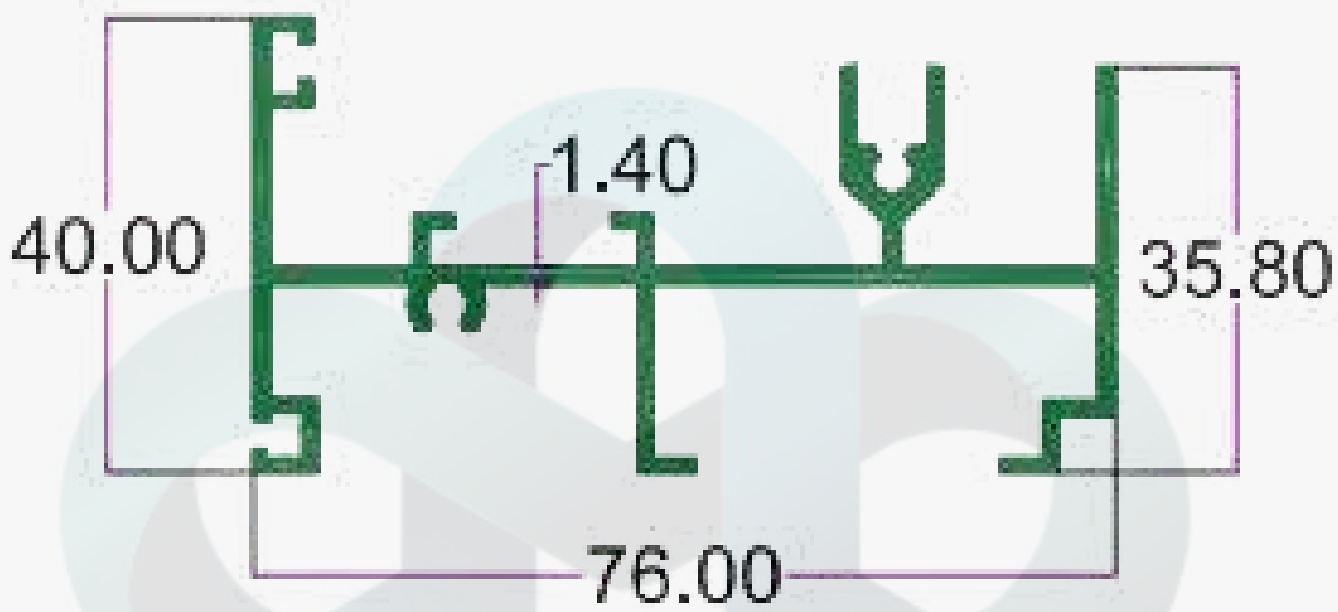

SEC. NO. 4029

WT. 3.400 TO 3.700 KG/12'

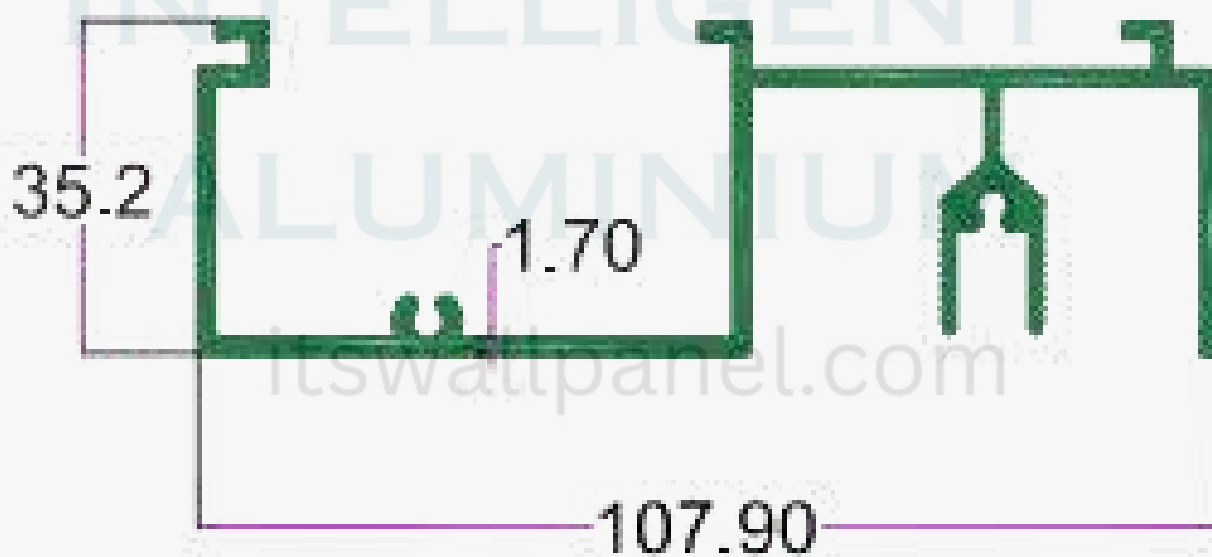

SEC. NO. 4032

WT. 4.700 TO 5.100 KG/12'

SLIDING SERIES



INTELLIGENT
ALUMINIUM
itswallpanel.com

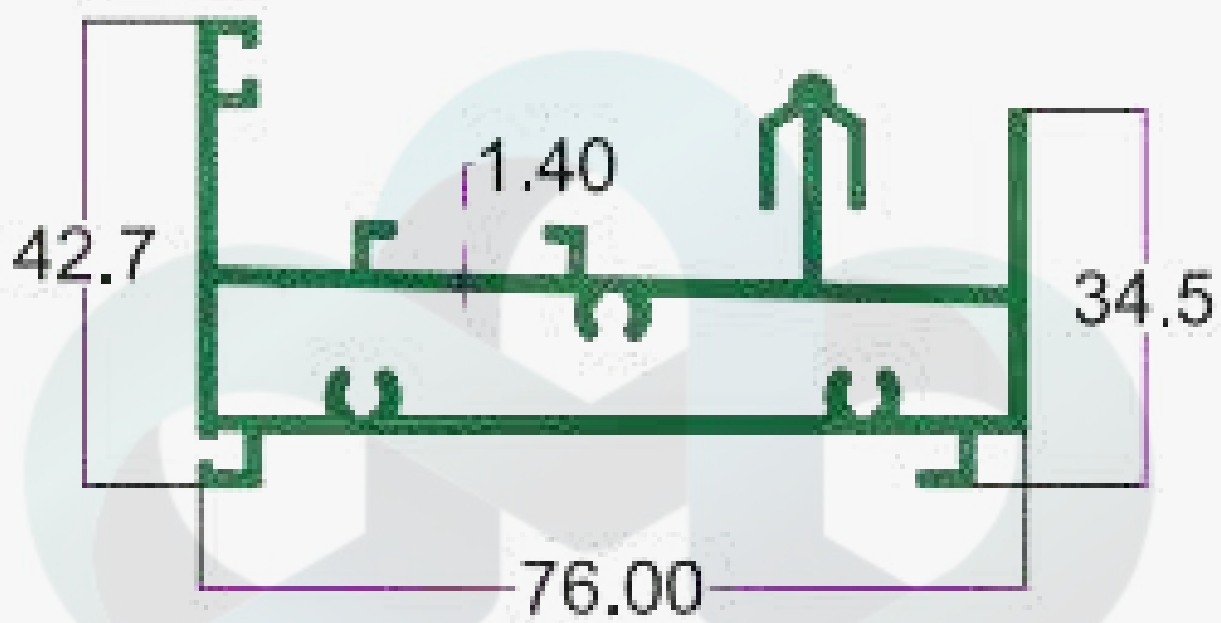

SEC. NO. 4030

WT. 4.100 TO 4.400 KG/12'

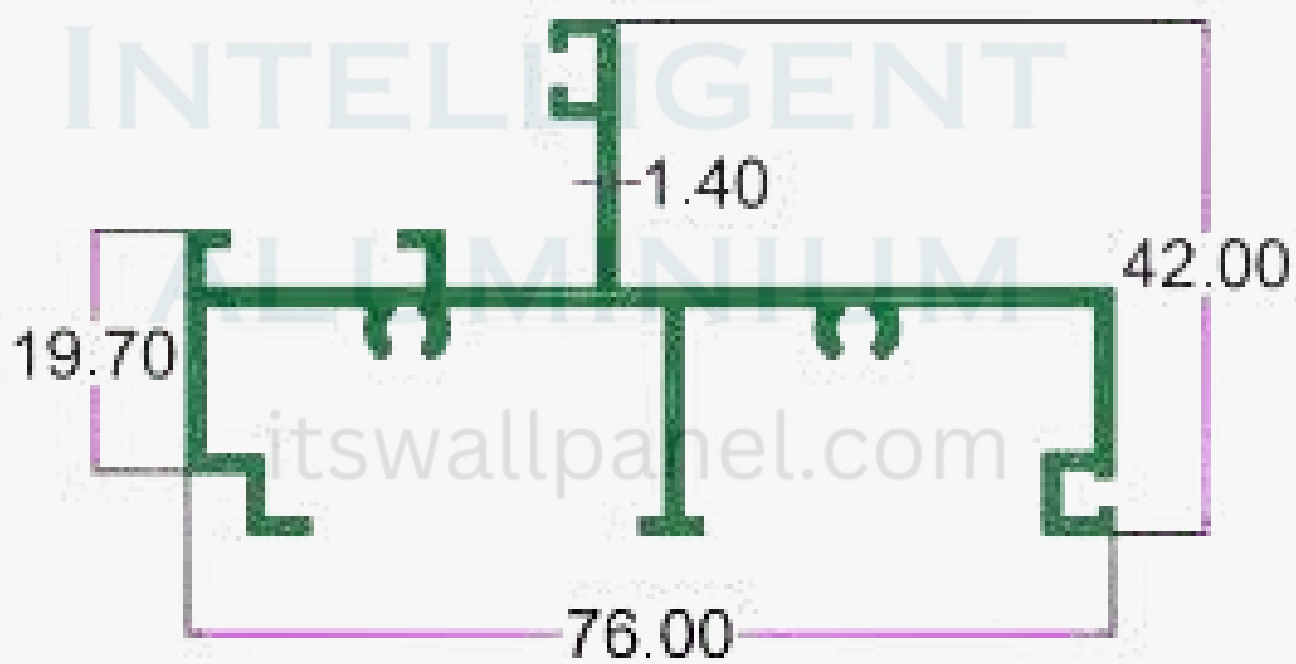

SEC. NO. 4034

WT. 2.800 TO 3.100 KG/12'

SLIDING SERIES



INTELLIGENT
ALUMINIUM
itswallpanel.com

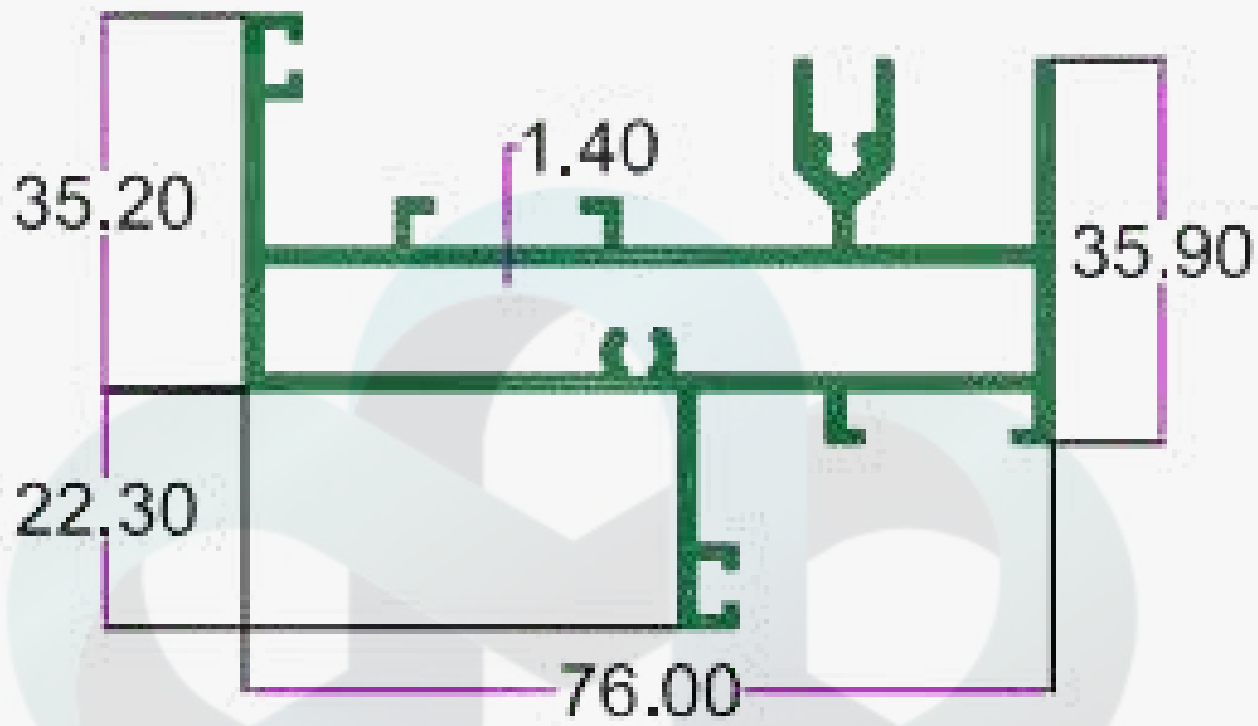

SEC. NO. 4036

WT. 4.450 TO 4.800 KG/12'

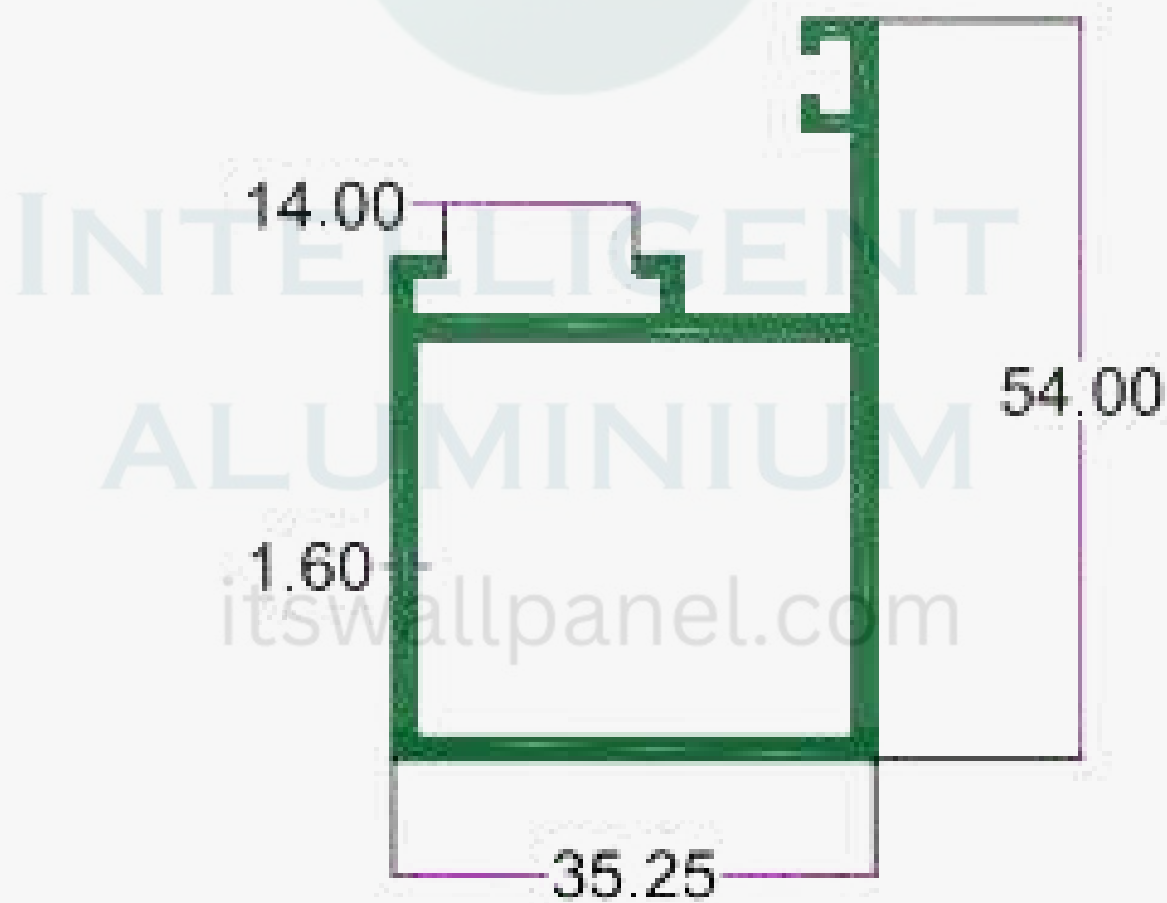

SEC. NO. 4035

WT. 2.600 TO 3.000 KG/12'

SLIDING SERIES



INTELLIGENT
ALUMINIUM
itswallpanel.com

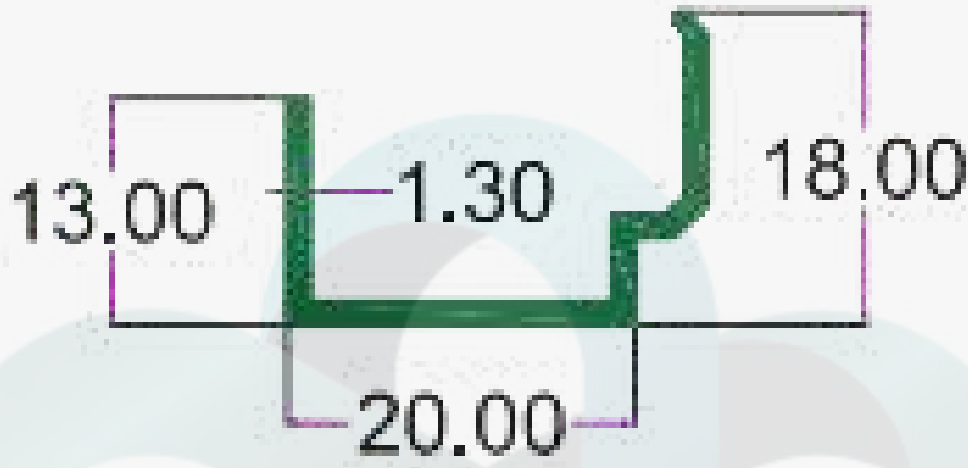

SEC. NO. 3526

WT. 0.630 TO 0.710 KG/12'



SEC. NO. 4103

WT. 1.550 TO 1.700 KG/12'

SLIDING SERIES



INTELLIGENT
ALUMINIUM
itswallpanel.com

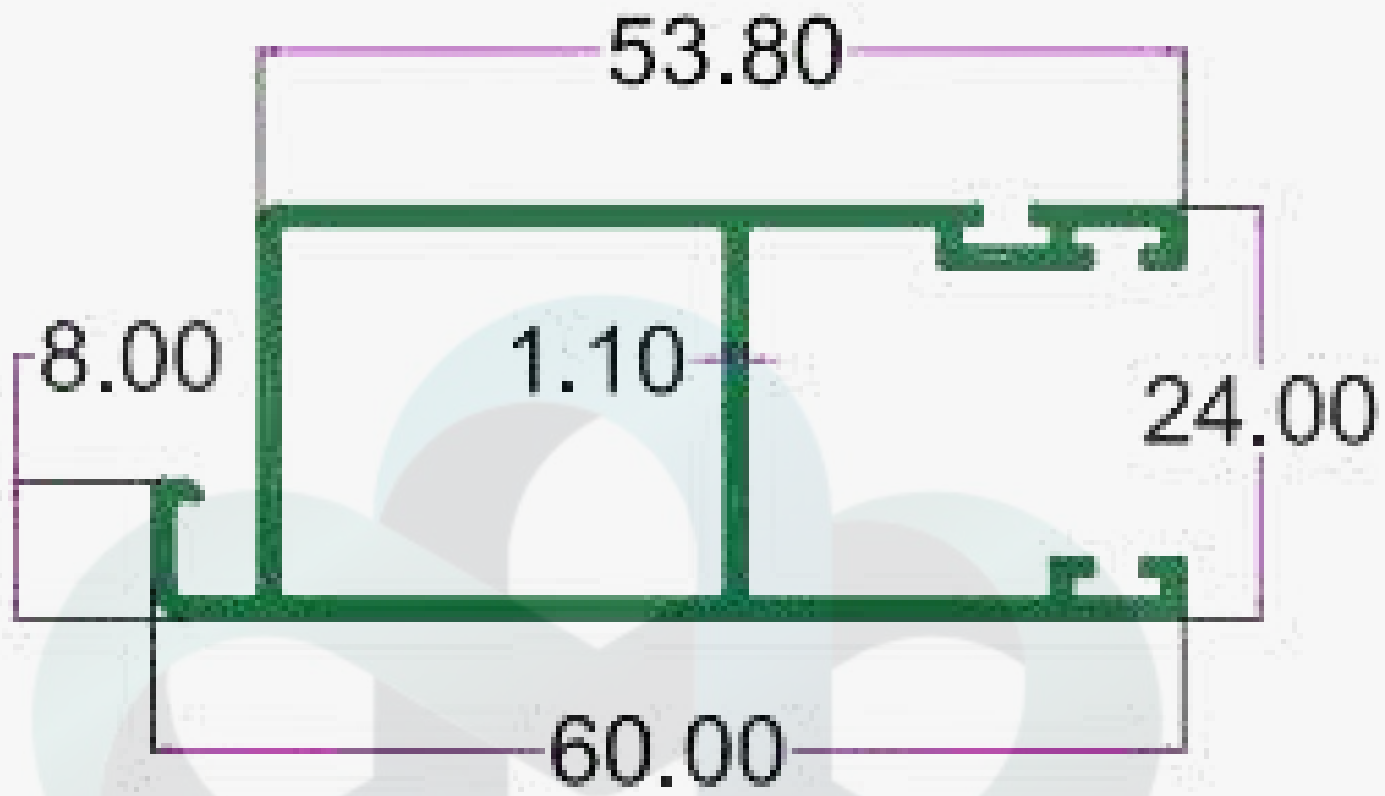

SEC.NO. 4588

WT. 1.980 TO 2.200 KG/12'

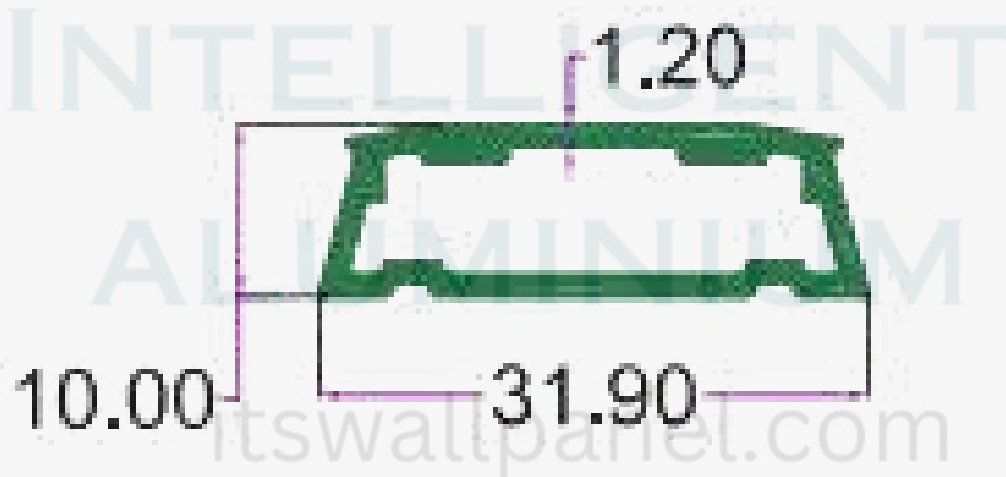

SEC.NO. 4826

WT. 1.020 TO 1.170 KG/12'

SLIDING SERIES



INTELLIGENT
ALUMINIUM
itswallpanel.com

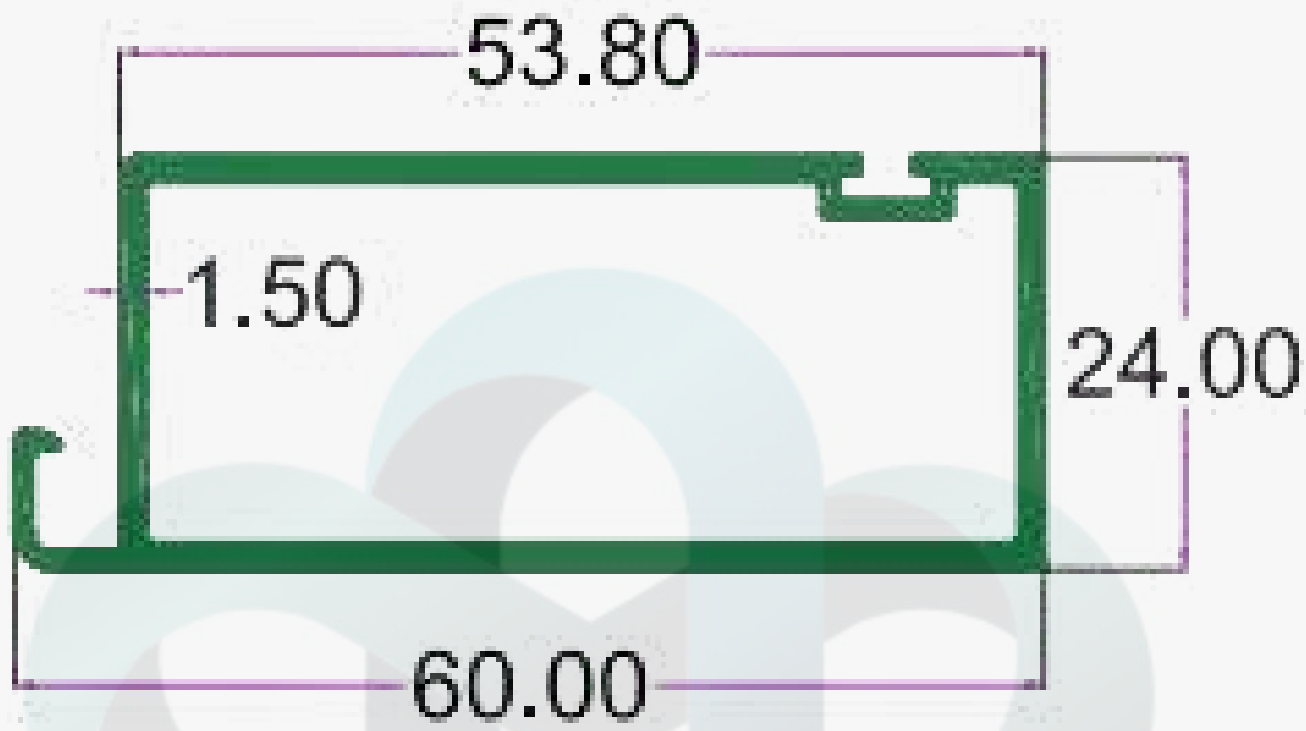

SEC.NO. 4587

WT. 2.400 TO 2.600 KG/12'

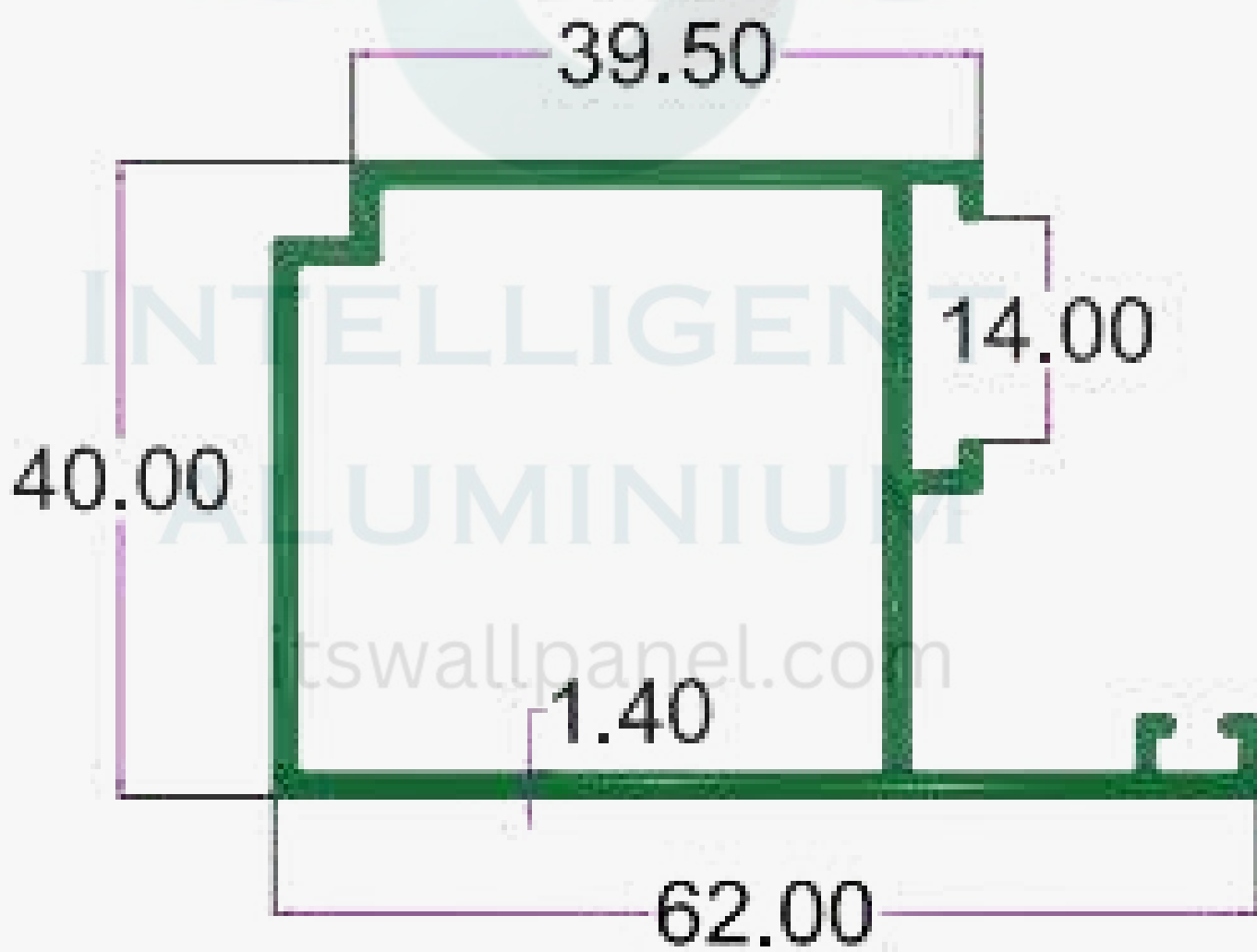

SEC.NO. 4589

WT. 2.700 TO 3.000 KG/12'

SLIDING SERIES



INTELLIGENT
ALUMINIUM
itswallpanel.com

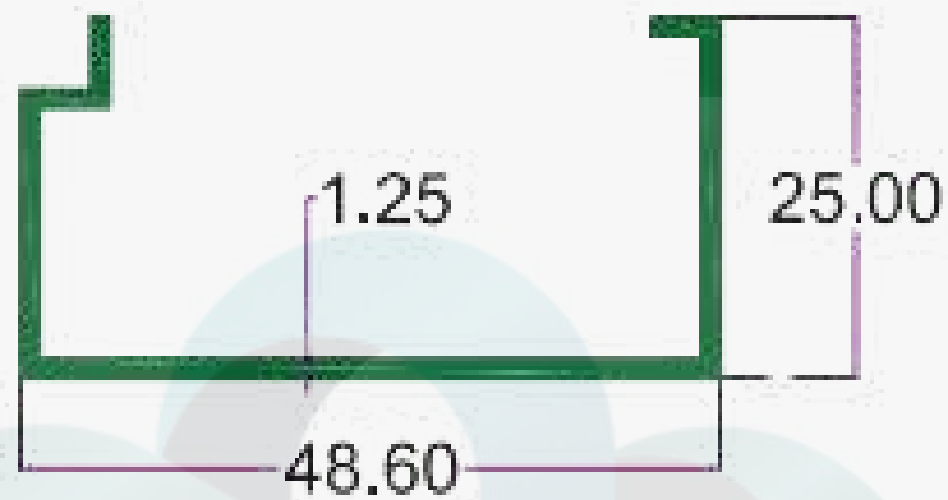

SEC. NO. 4031

WT. 1.300 TO 1.600 KG/12'

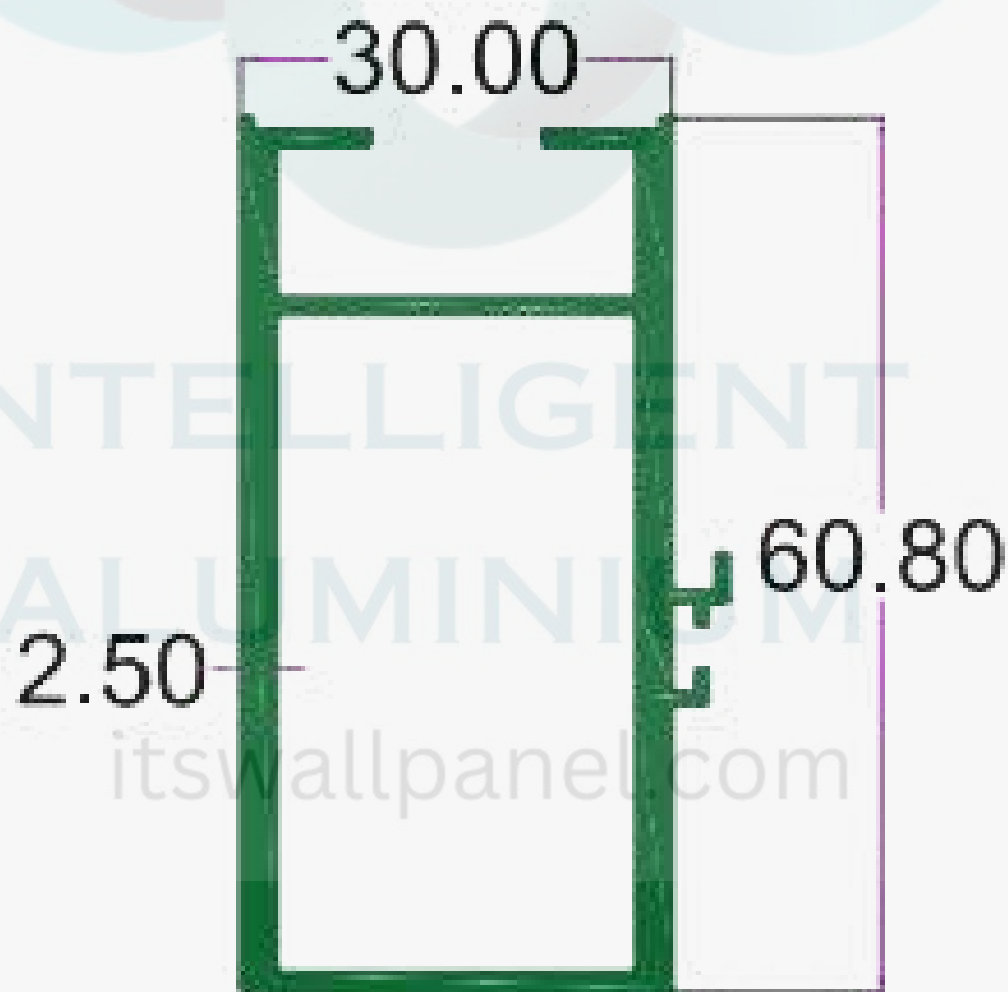

SEC. NO. 3992

WT. 3.900 TO 4.200 KG/12'

SLIDING SERIES



INTELLIGENT
ALUMINIUM
itswallpanel.com

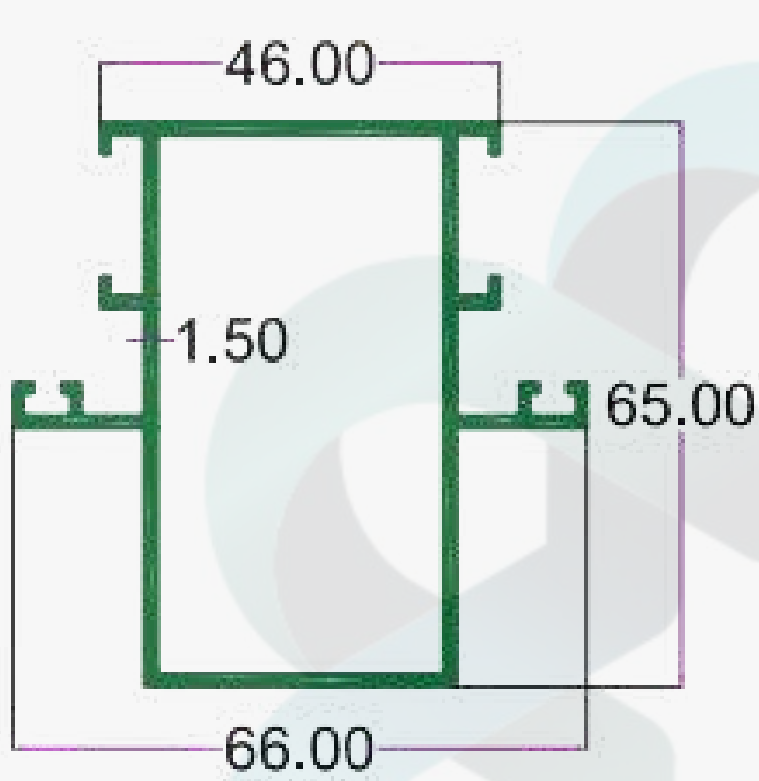

SEC. NO. 4101
WT. 3.920 TO 4.250 KG/12'

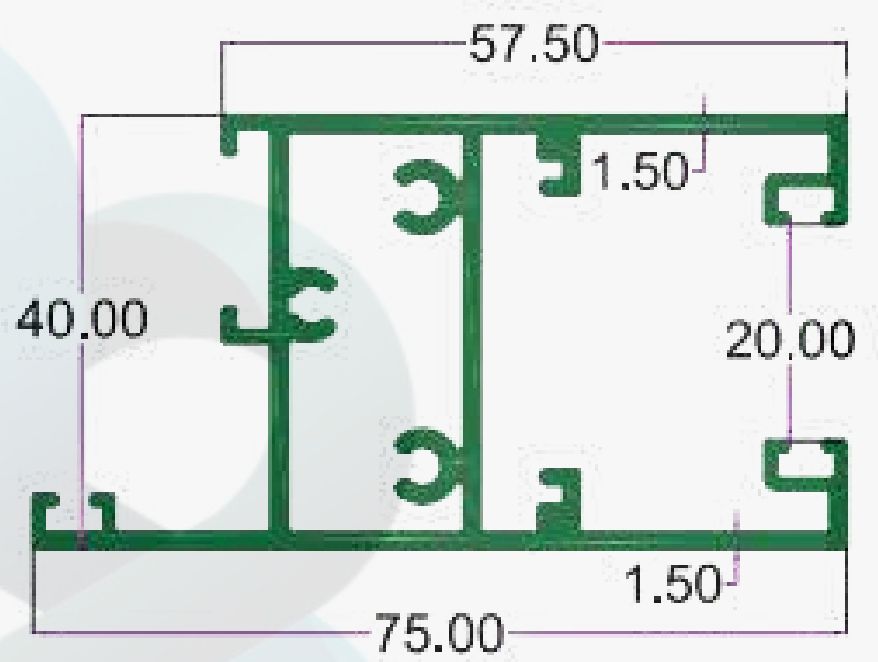

SEC. NO. 4586
WT. 4.580 TO 4.900 KG/12'

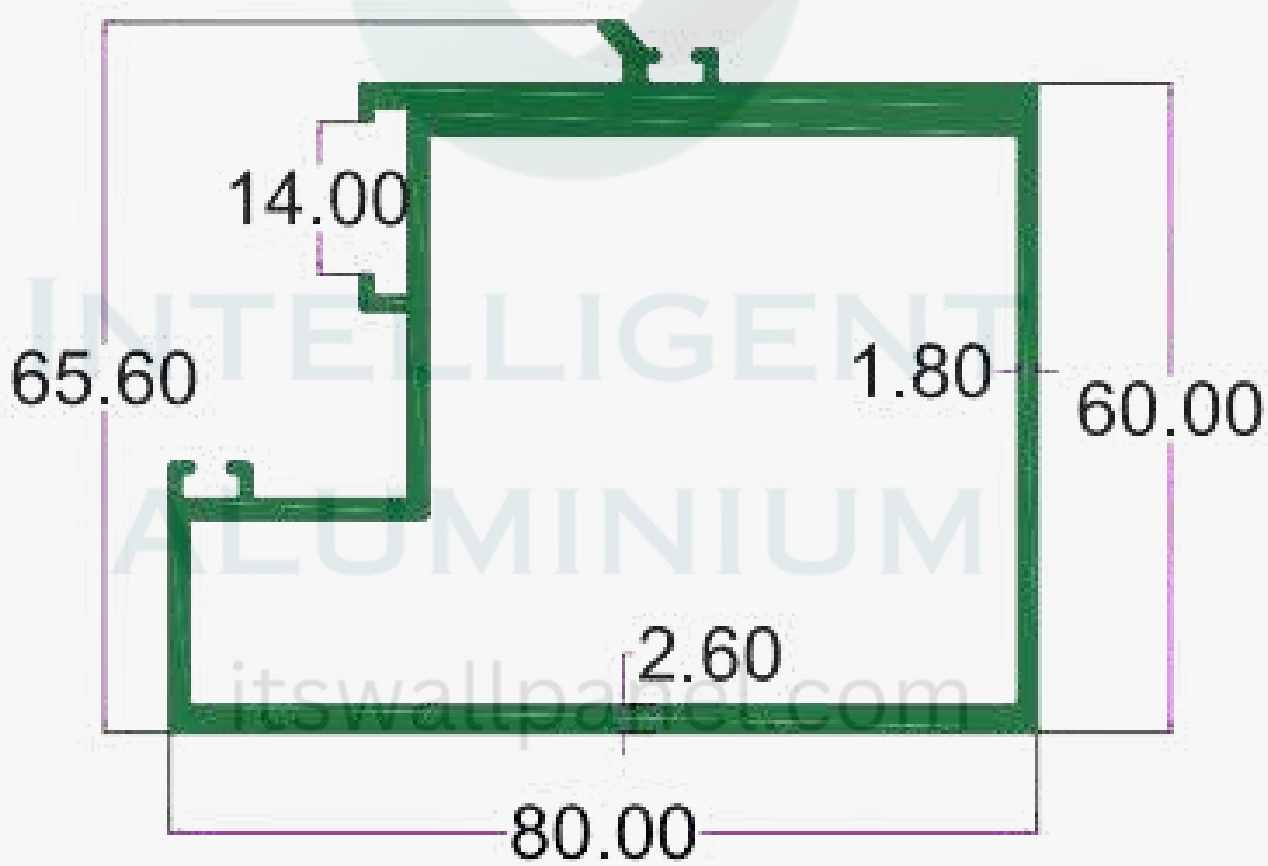

SEC. NO. 4585
WT. 7.530 TO 7.700 KG/12'

SLIDING SERIES



INTELLIGENT
ALUMINIUM
itswallpanel.com

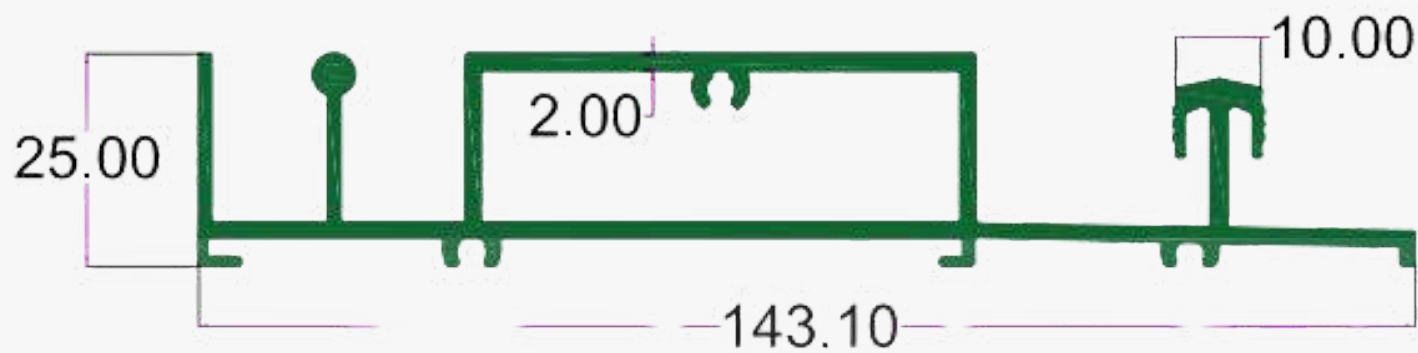

SEC.NO. 4582
WT. 6.280 TO 6.400 KG/12'

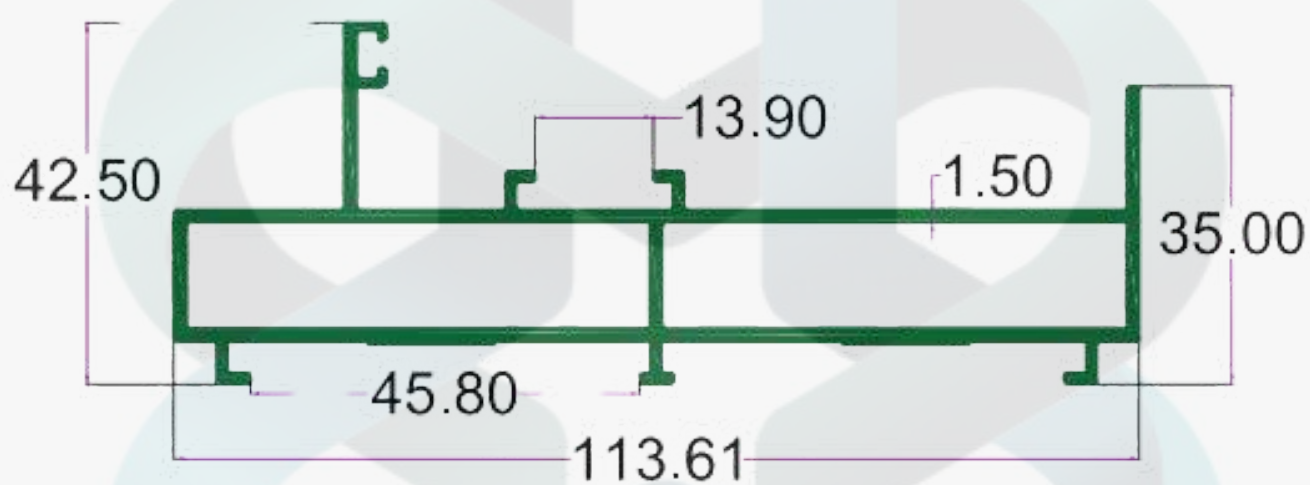

SEC.NO. 4580
WT. 5.140 TO 5.300 KG/12'

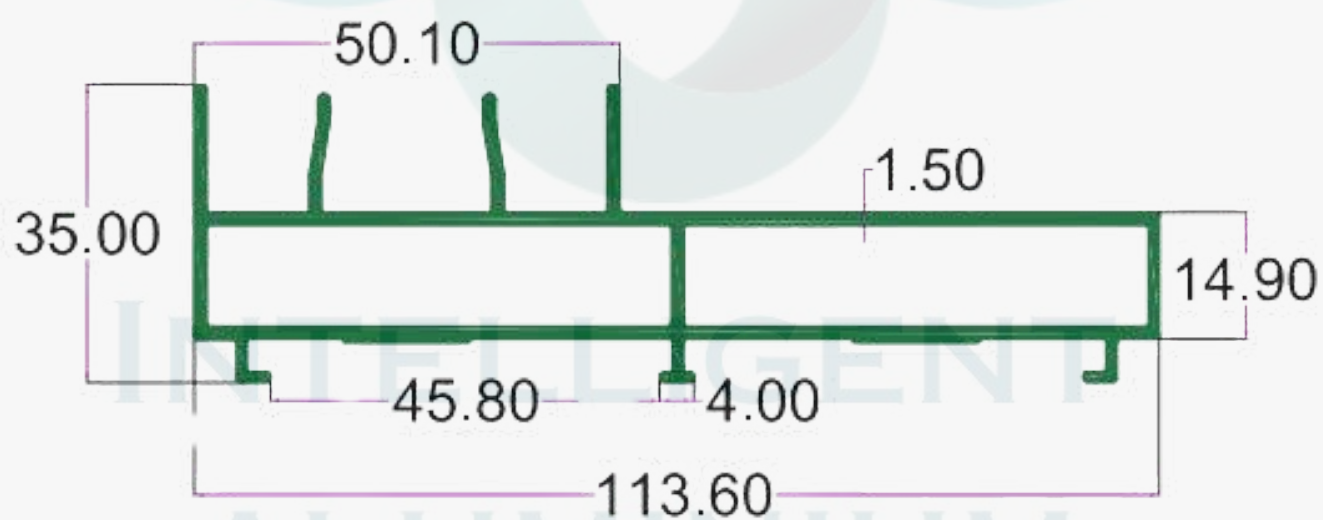

SEC.NO. 4579
WT. 5.140 TO 5.300 KG/12'

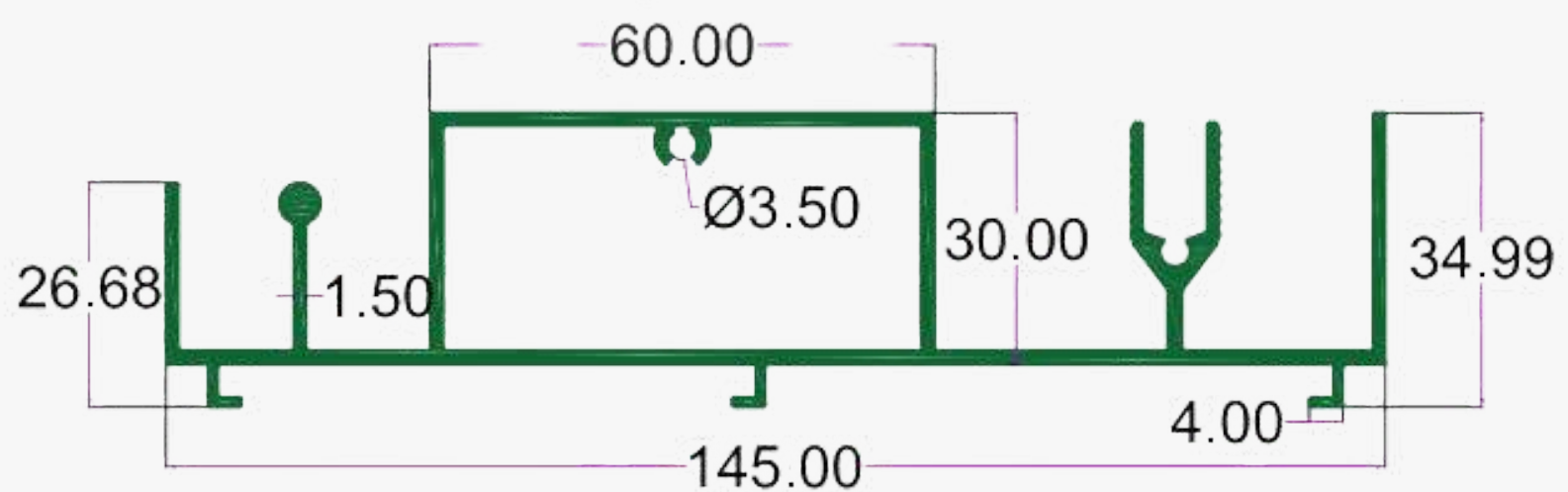

SEC.NO. 4581
WT. 6.730 TO 6.900 KG/12'

SLIDING SERIES



INTELLIGENT
ALUMINIUM
itswallpanel.com

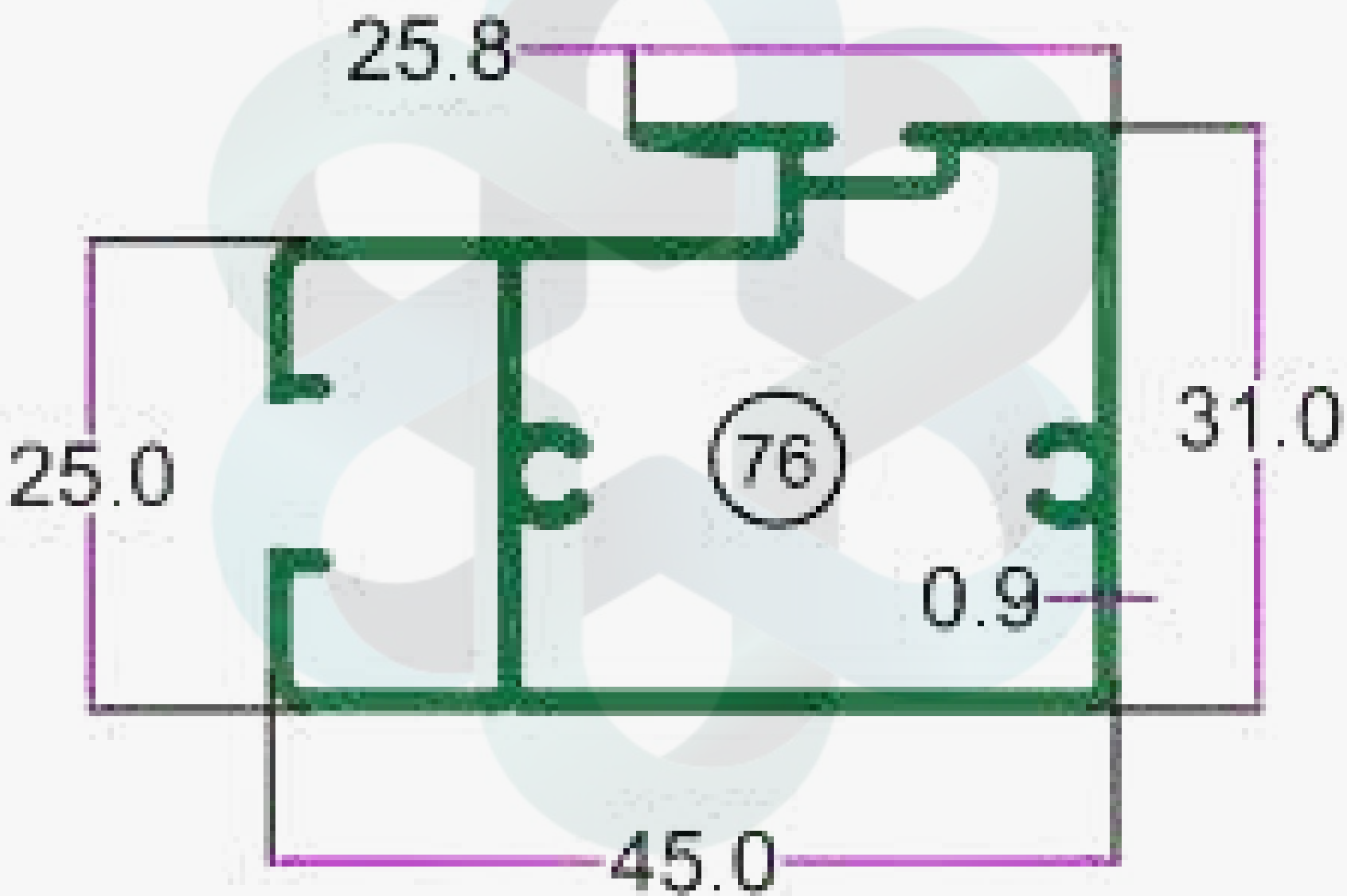

INTELLIGENT
ALUMINIUM

itswallpanel.com

SEC. NO. 3352

WT. 1.850 TO 2.000 KG/12'

SLIDING SERIES



INTELLIGENT
ALUMINIUM
itswallpanel.com

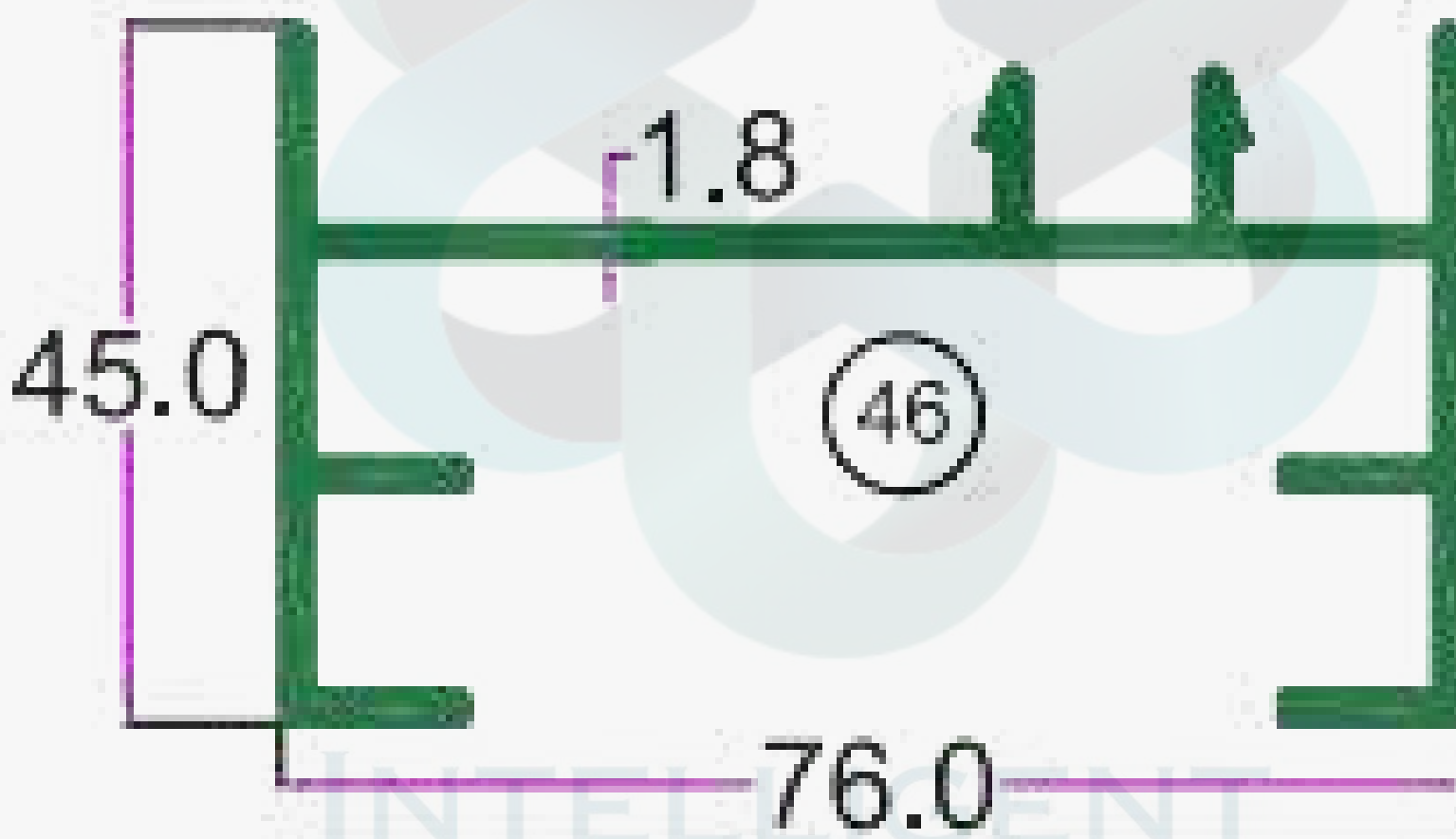

ALUMINIUM

itswallpanel.com

SEC. No. 3355

WT. 4.020 TO 4.150 KG/12'

SLIDING SERIES



INTELLIGENT
ALUMINIUM
itswallpanel.com

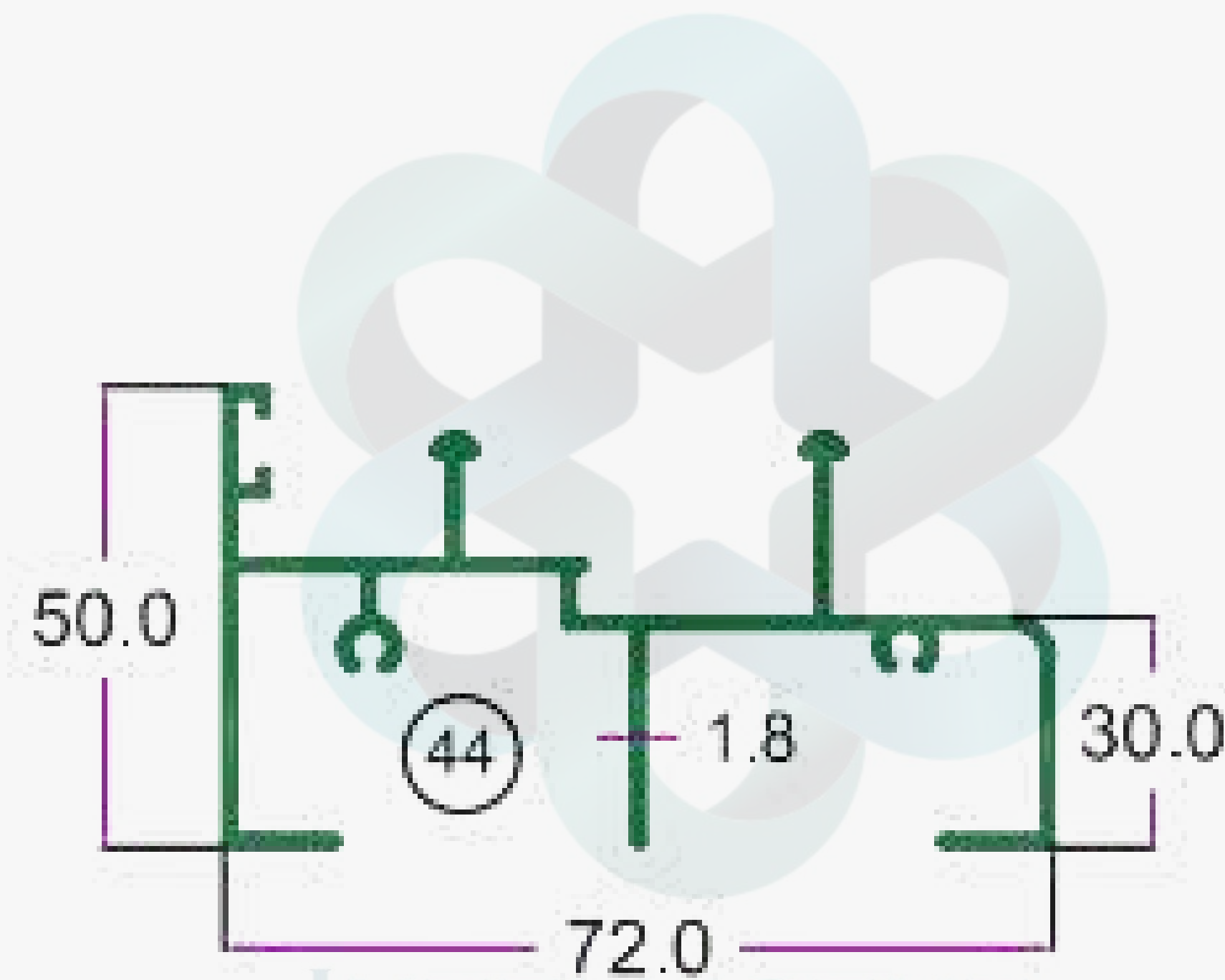

INTELLIGENT
ALUMINIUM

itswallpanel.com

SEC. No. 3356

WT. 4.650 TO 4.800 KG/12'

SLIDING SERIES



INTELLIGENT
ALUMINIUM
itswallpanel.com

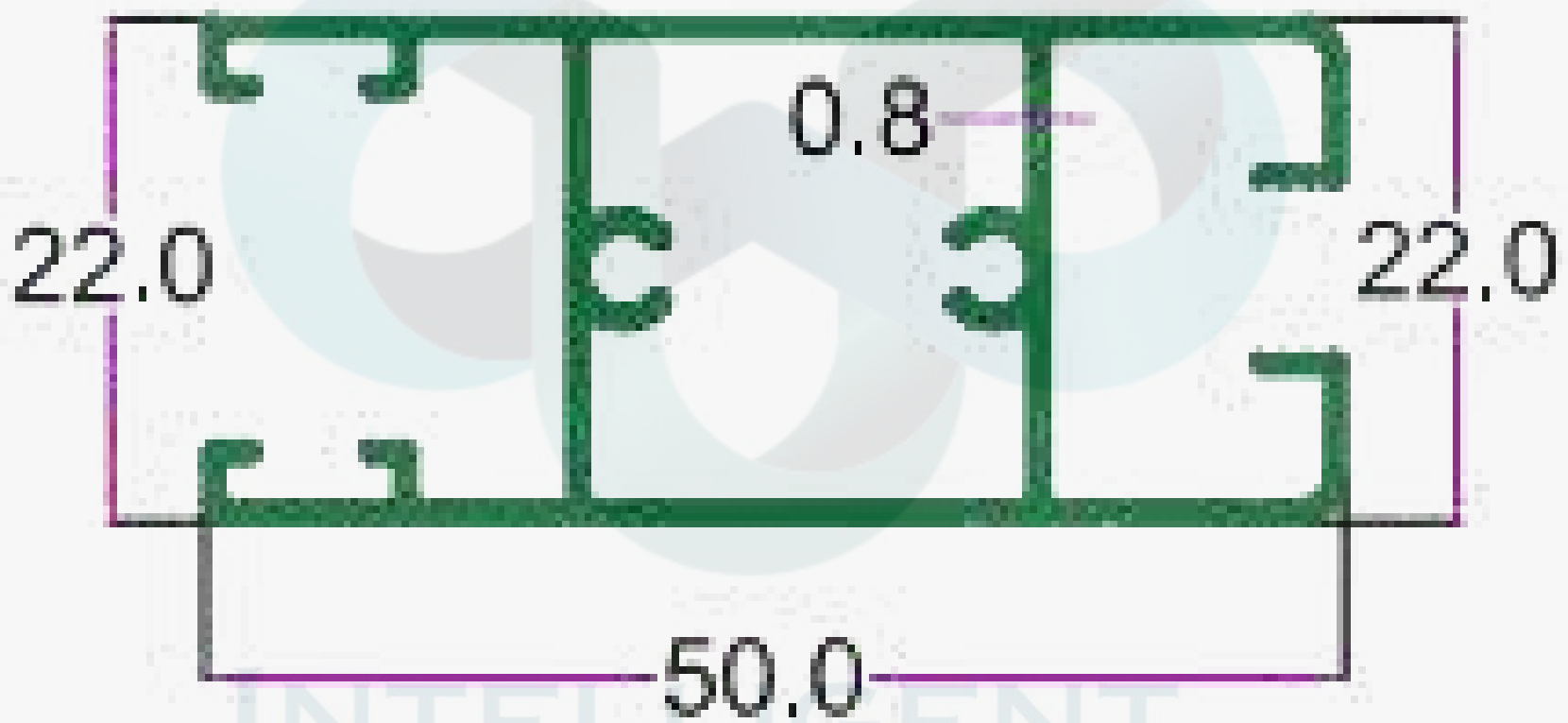

INTELLIGENT
ALUMINIUM

itswallpanel.com

SEC. No. 3353

WT. 1.550 TO 2.000 KG/12'

SLIDING SERIES



INTELLIGENT
ALUMINIUM
itswallpanel.com

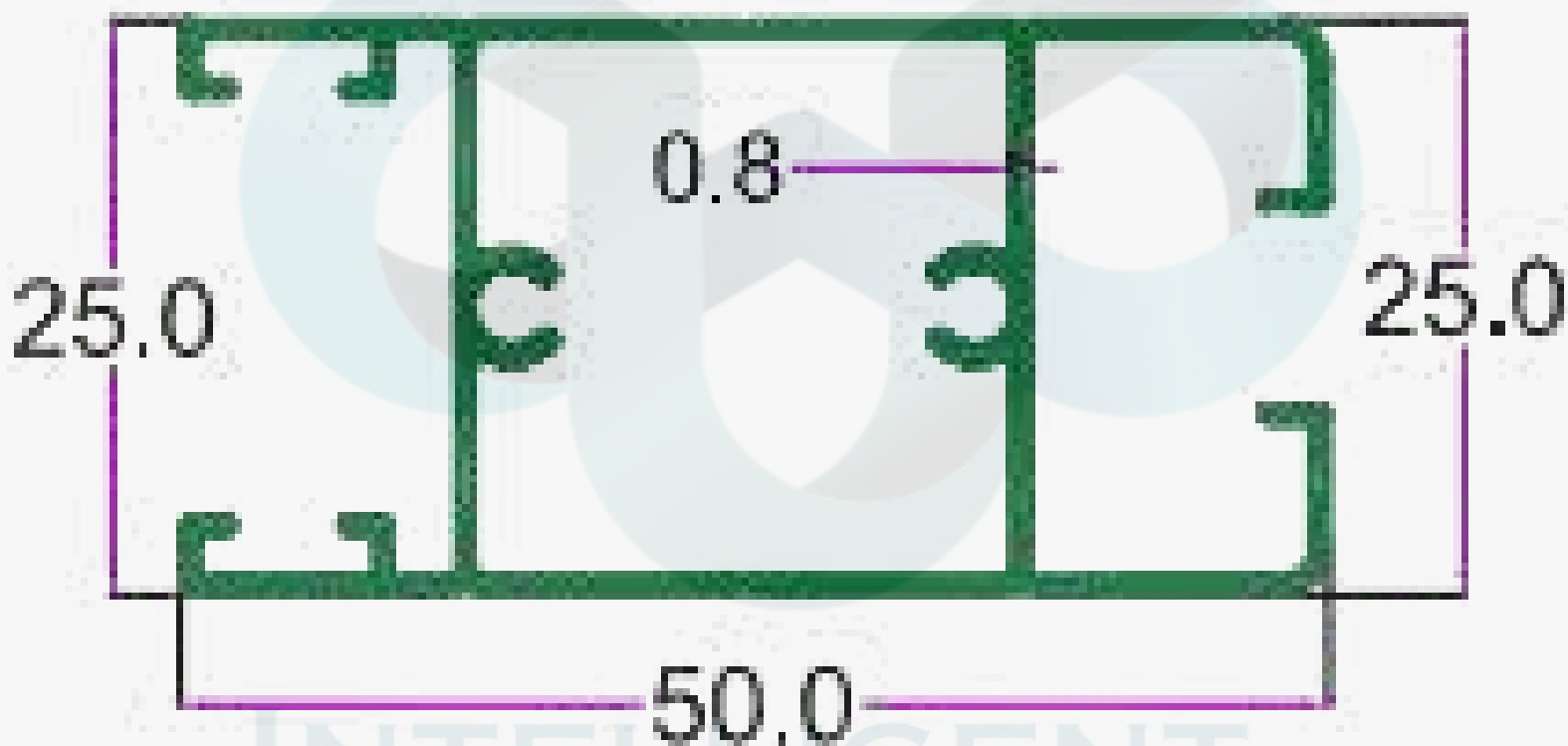

INTELLIGENT
ALUMINIUM

itswallpanel.com

SEC. No. 3354

WT. 1.550 TO 2.000 KG/12'

SLIDING SERIES



INTELLIGENT
ALUMINIUM
itswallpanel.com

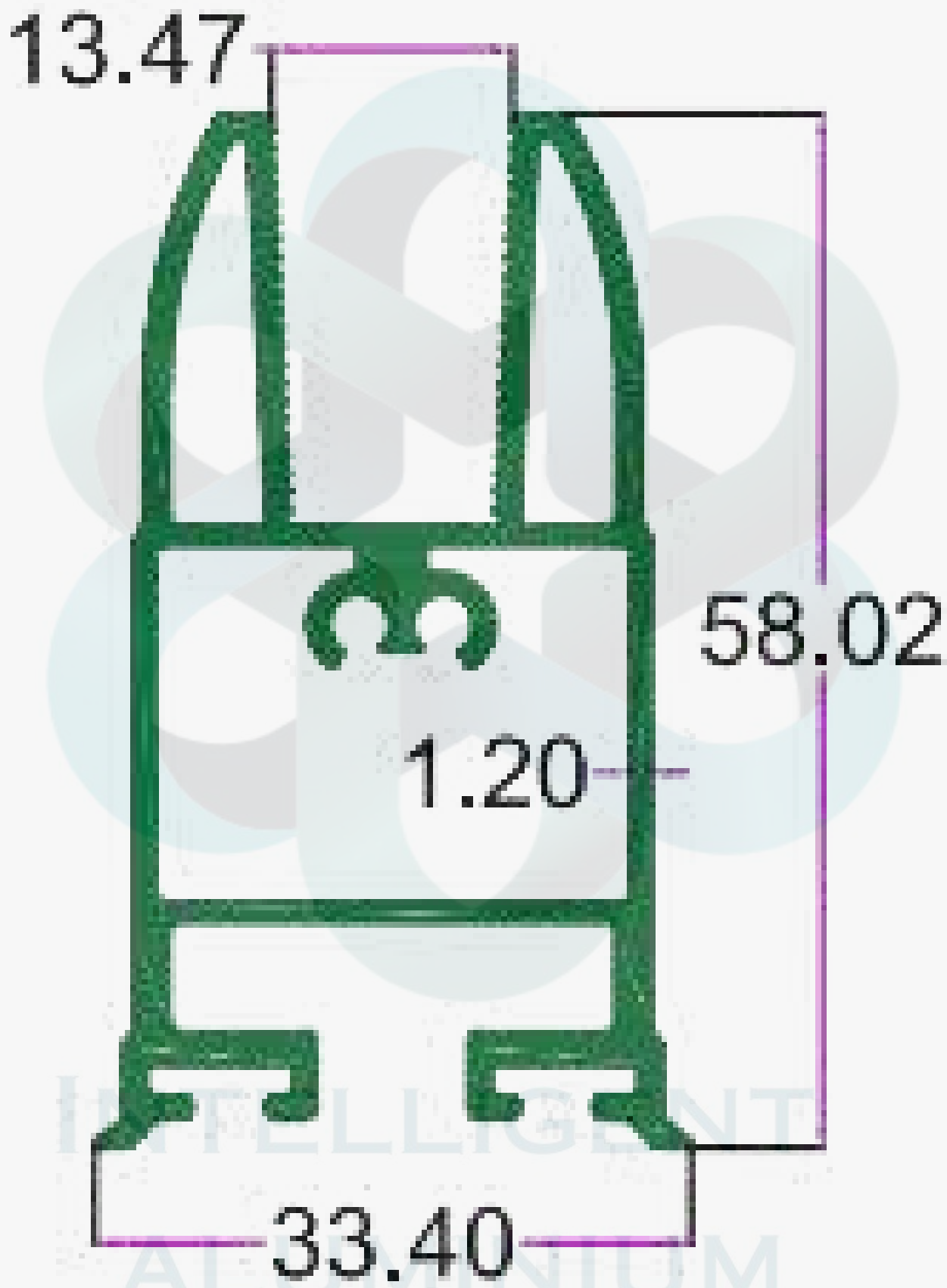

itswallpanel.com

SEC.NO. 5III

WT. 3.648 TO 3.895 KG/12'

SLIDING SERIES



INTELLIGENT
ALUMINIUM
itswallpanel.com

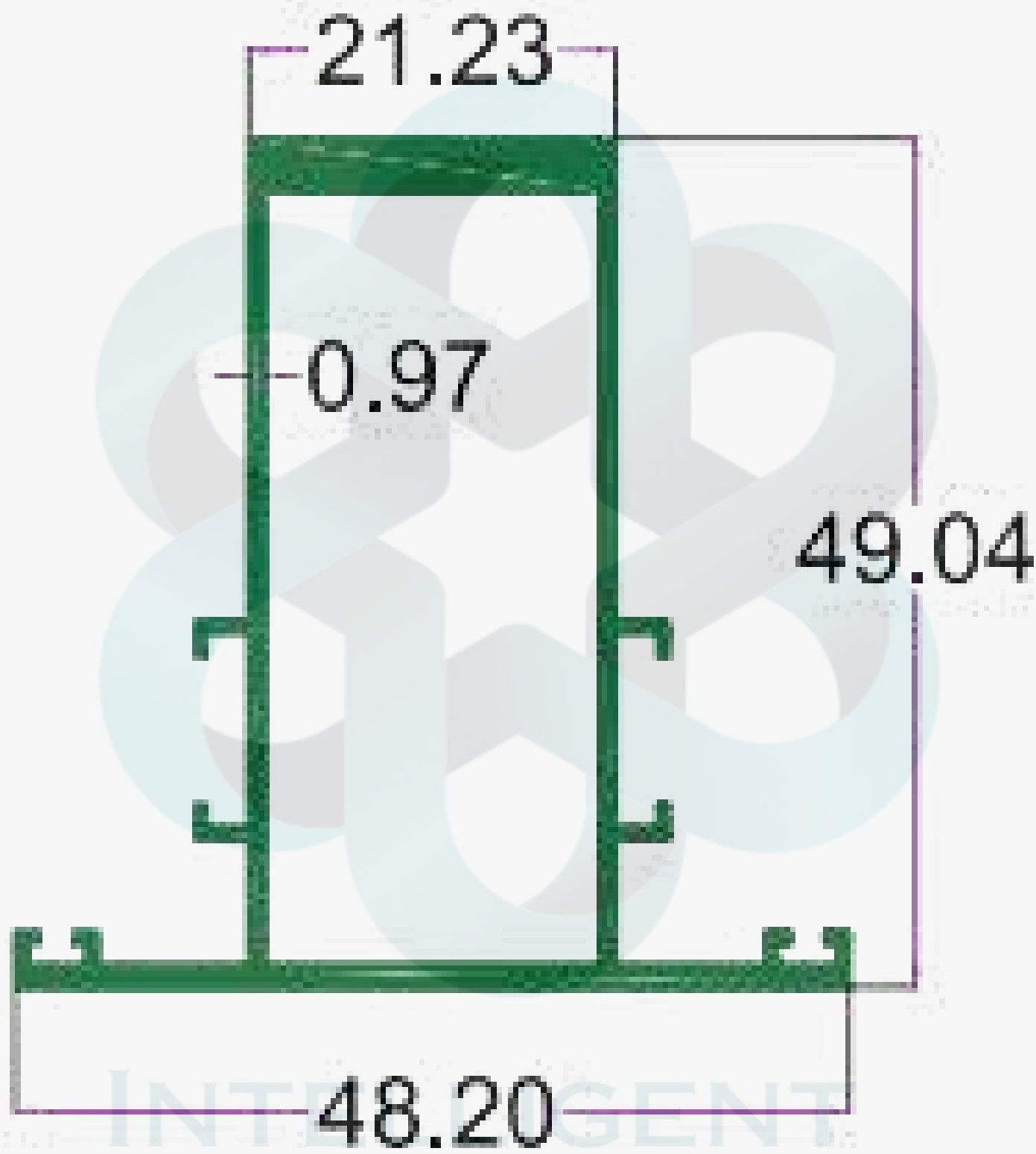

INTELLIGENT
ALUMINIUM

itswallpanel.com

SEC. NO. 4033

WT. 6.200 TO 6.600 KG/12'

SLIDING SERIES



INTELLIGENT
ALUMINIUM
itswallpanel.com

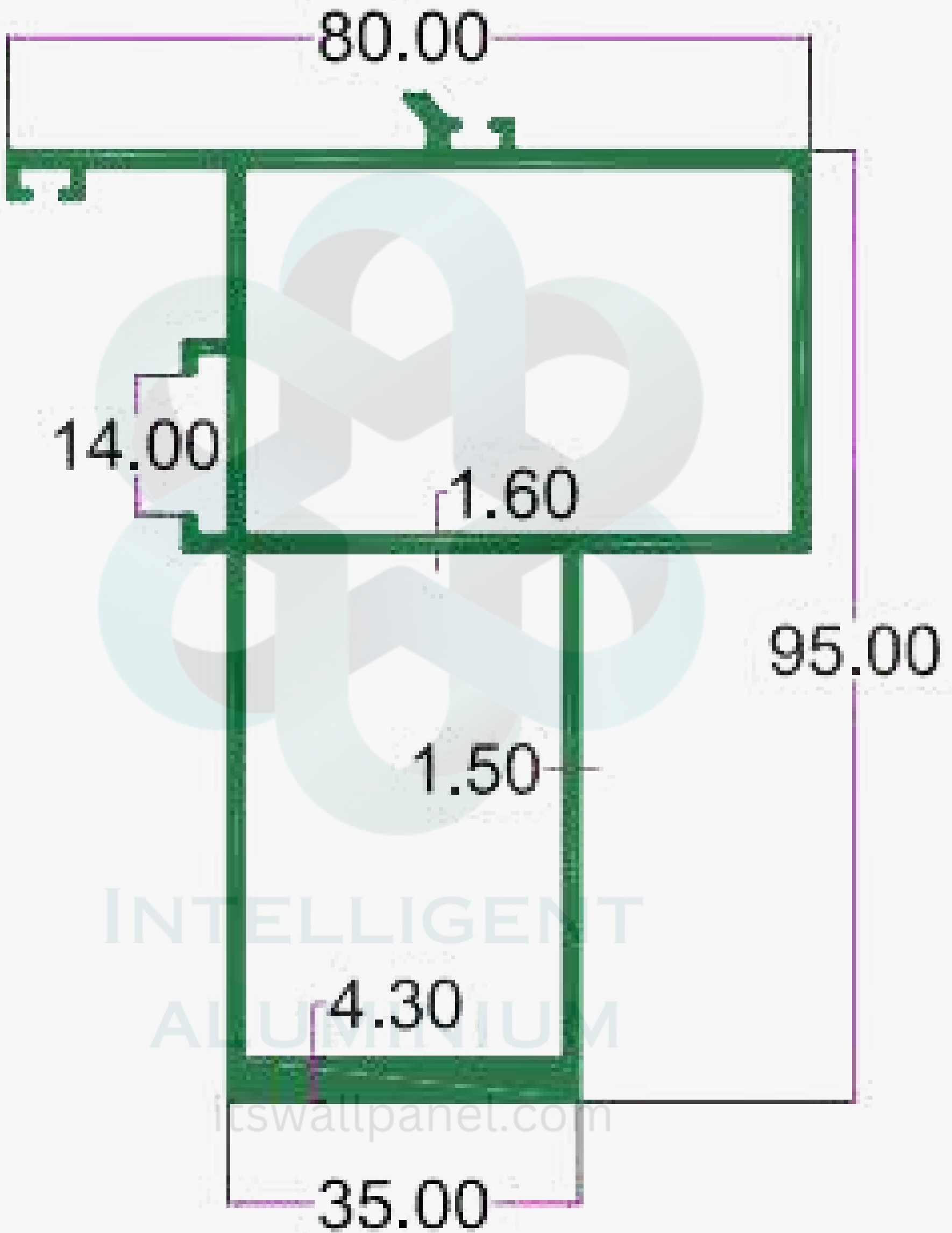

SEC.NO. 4584

WT. 6.930 TO 7.200 KG/12'

SLIDING SERIES



INTELLIGENT
ALUMINIUM
itswallpanel.com

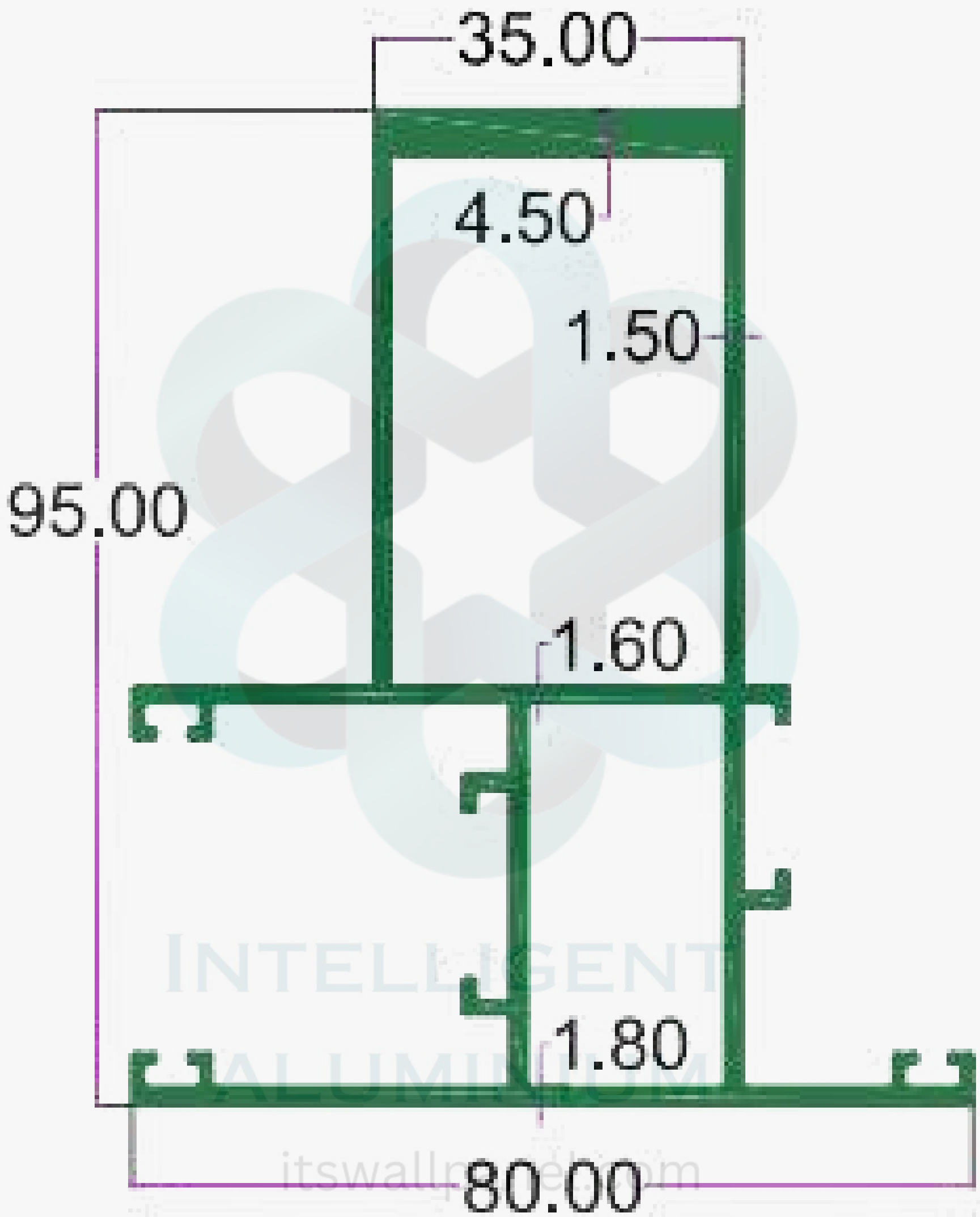

SEC.NO. 4583

WT. 7.170 TO 7.350 KG/12'

SLIDING SERIES



INTELLIGENT
ALUMINIUM
itswallpanel.com

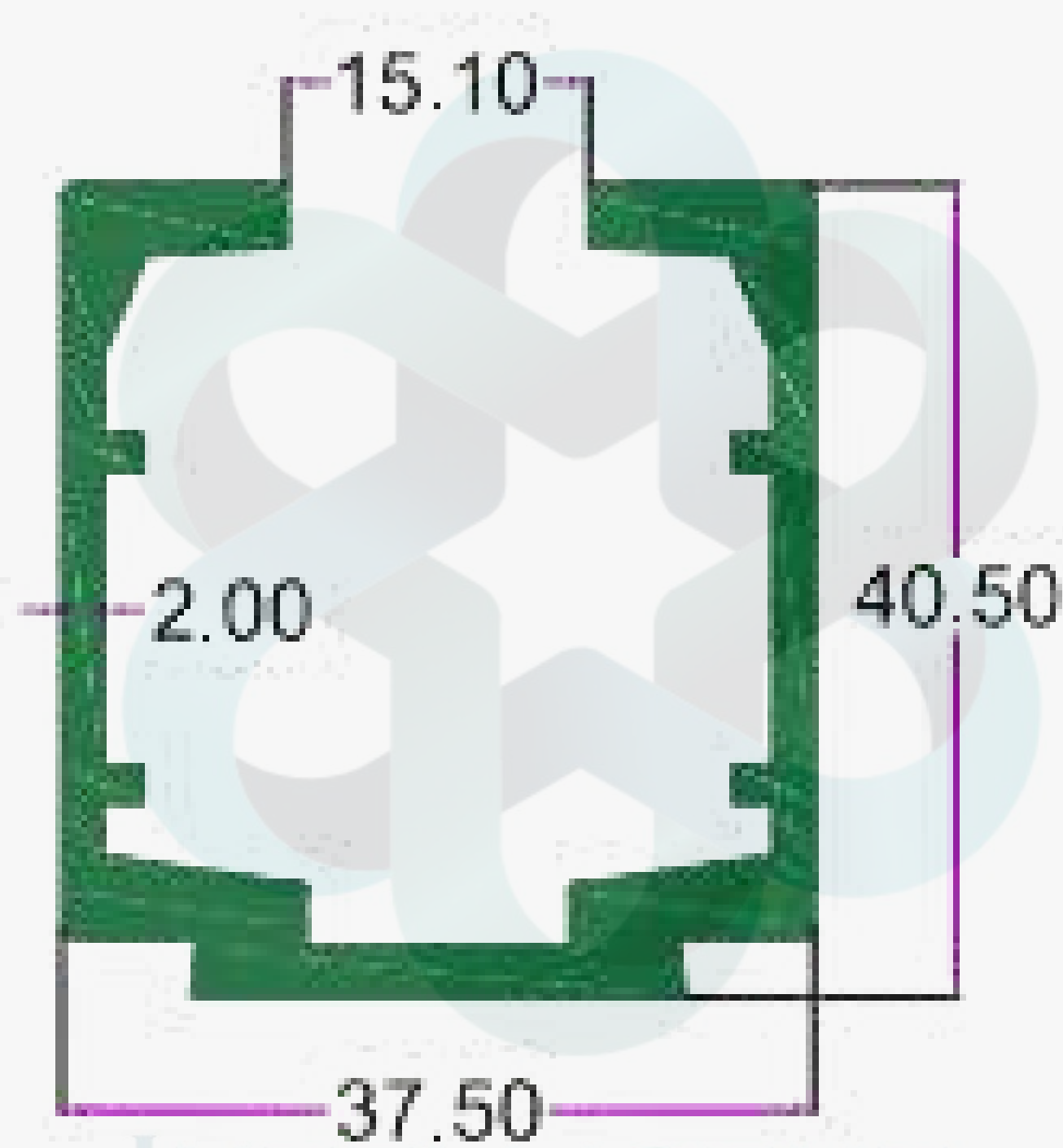

INTELLIGENT
ALUMINIUM

itswallpanel.com

SEC. NO. 3350

WT. 3.460 TO 3.822 KG/12'

SLIDING SERIES



INTELLIGENT
ALUMINIUM
itswallpanel.com

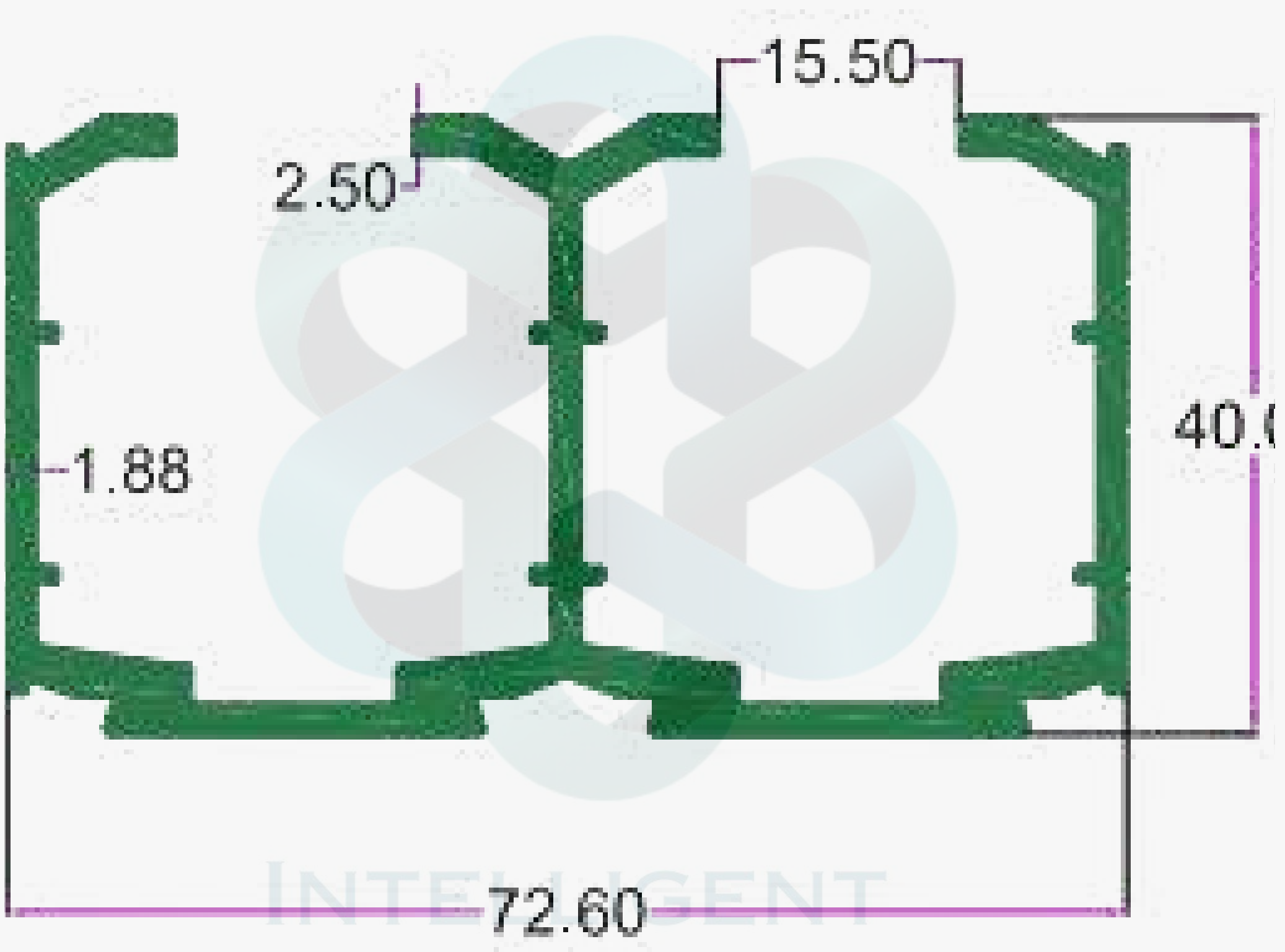

INTELLIGENT
ALUMINIUM

itswallpanel.com

SEC. NO. 4294

WT. 5.010 TO 5.350 KG/12'

SLIDING SERIES



INTELLIGENT
ALUMINIUM
itswallpanel.com

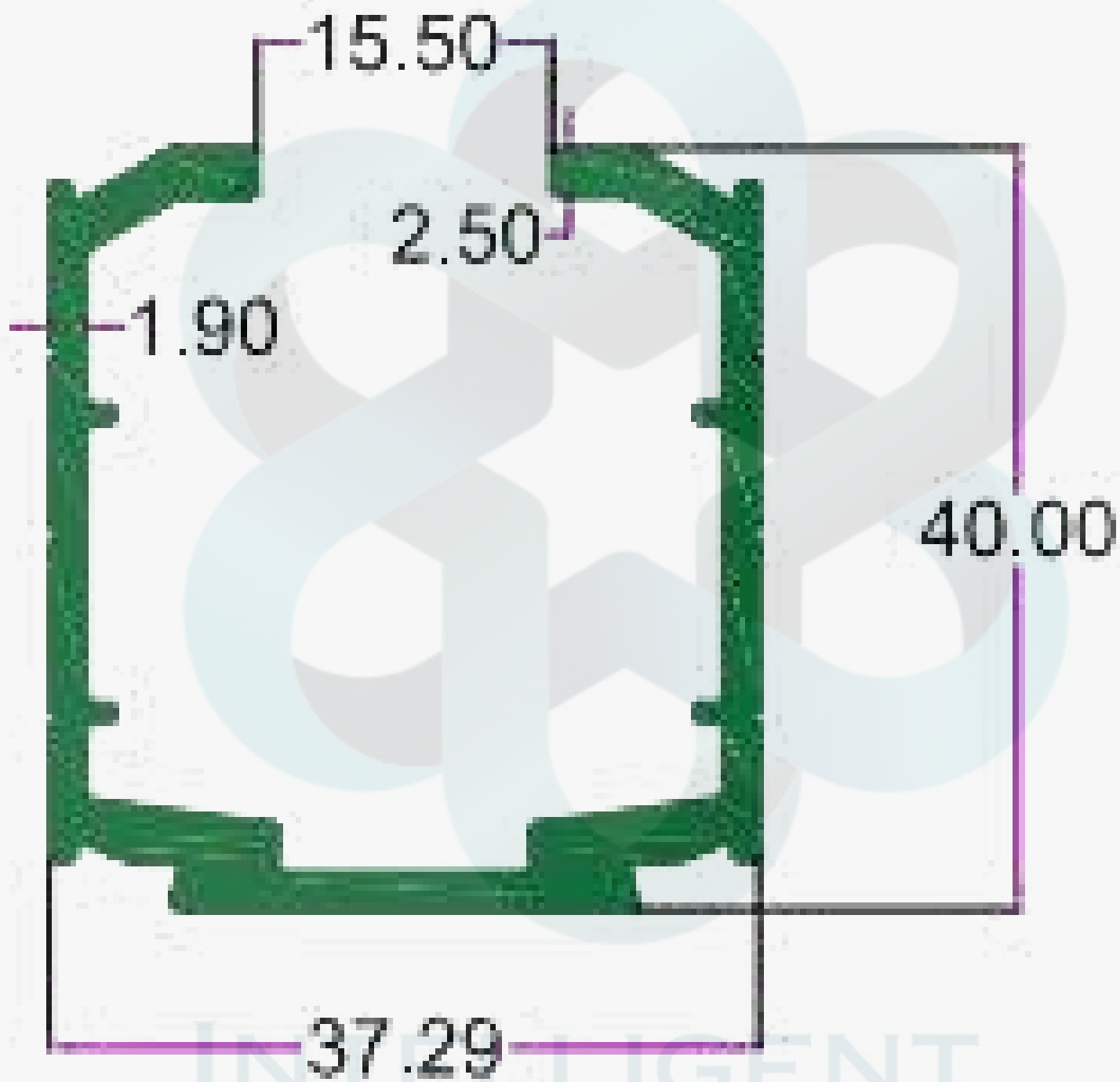

INTELLIGENT
ALUMINIUM

itswallpanel.com

SEC.NO. 4293

WT. 3.000 TO 3.200 KG/12'

SLIDING SERIES



INTELLIGENT
ALUMINIUM
itswallpanel.com

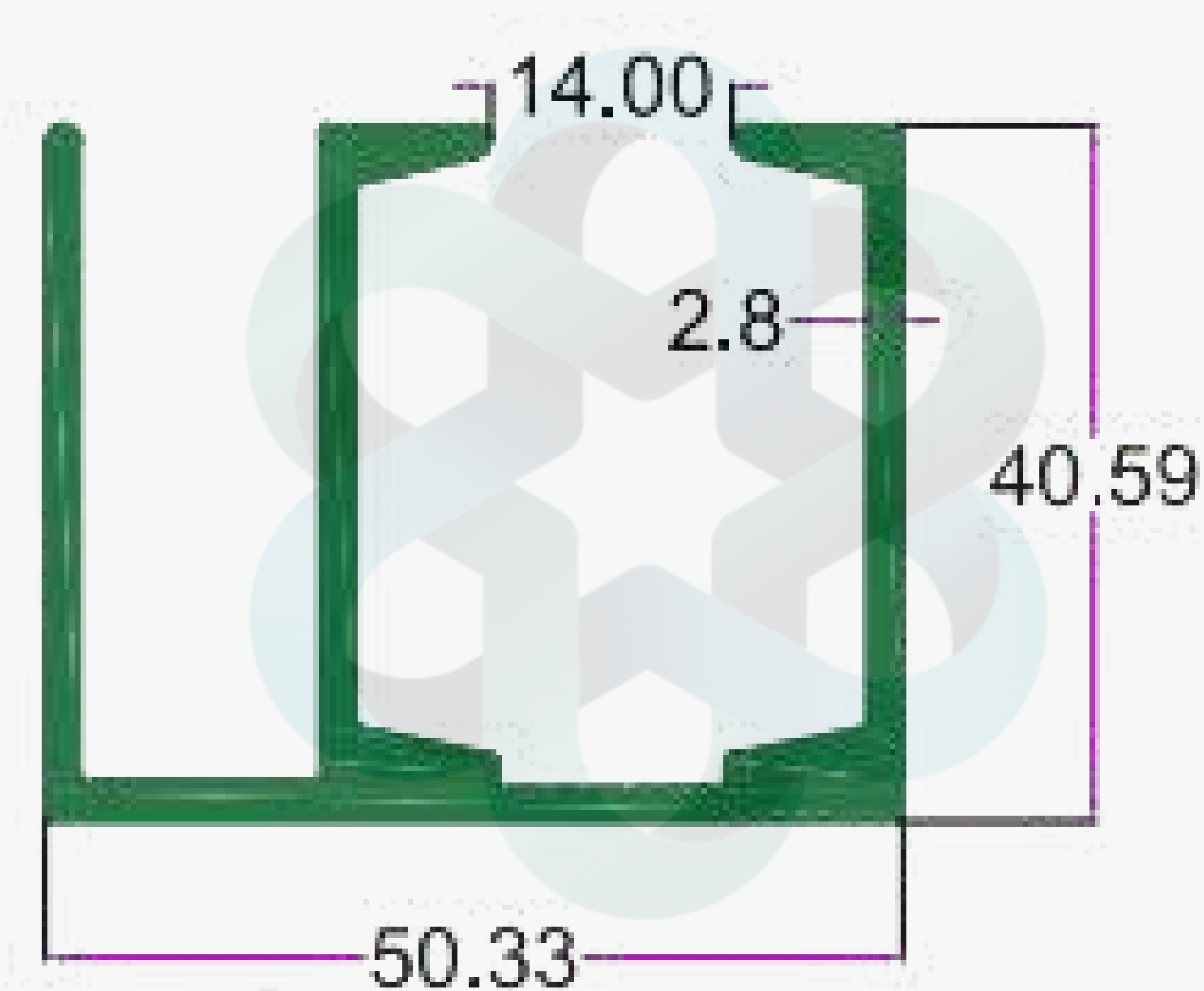

INTELLIGENT
ALUMINIUM

itswallpanel.com

SEC. NO. 3279

WT. 5.700 TO 6.000 KG/12'

SLIDING SERIES



INTELLIGENT
ALUMINIUM
itswallpanel.com

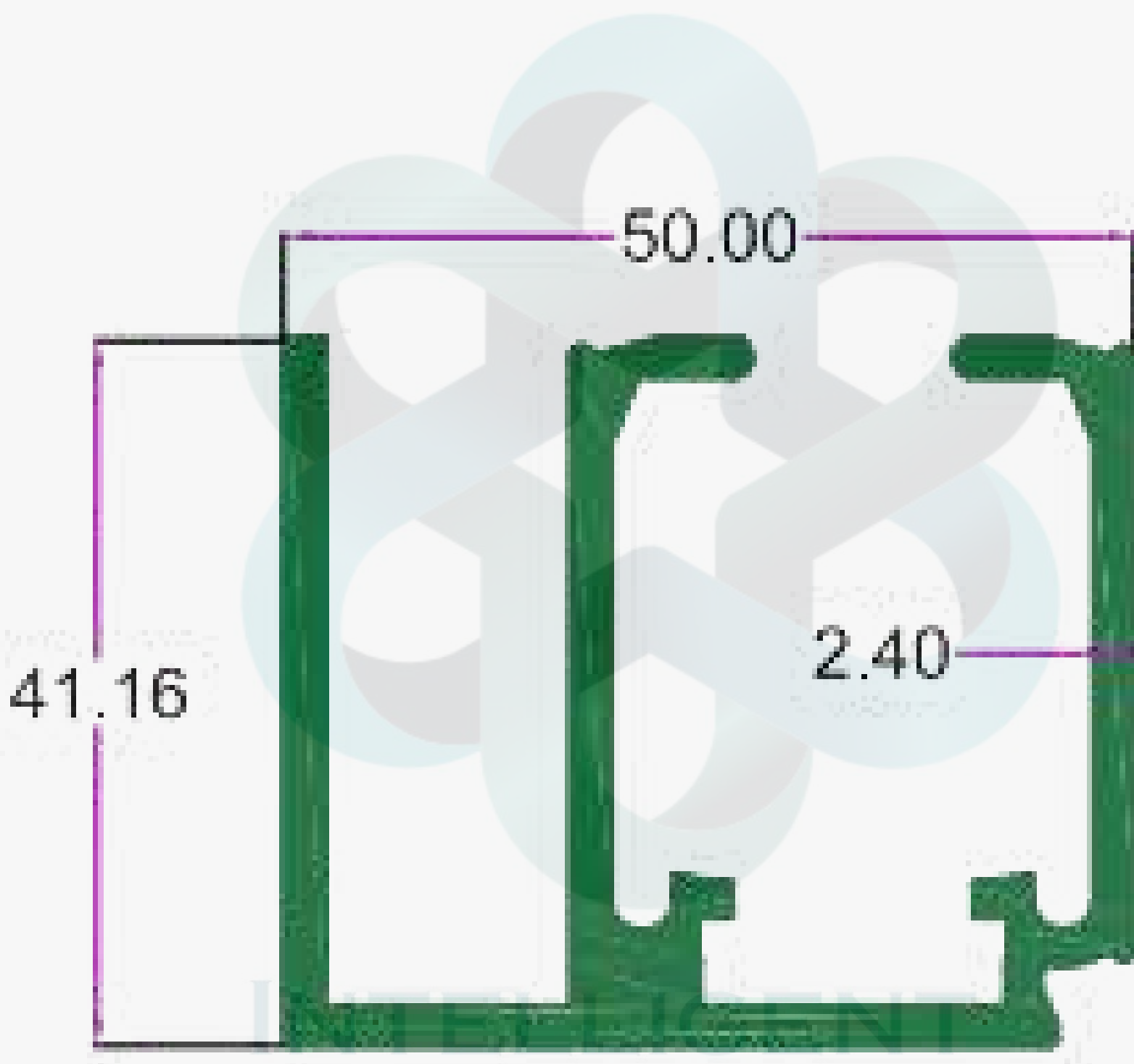

ALUMINIUM

itswallpanel.com

SEC. NO. 3961

WT. 4.600 TO 4.900 KG/12'

SLIDING SERIES



INTELLIGENT
ALUMINIUM
itswallpanel.com

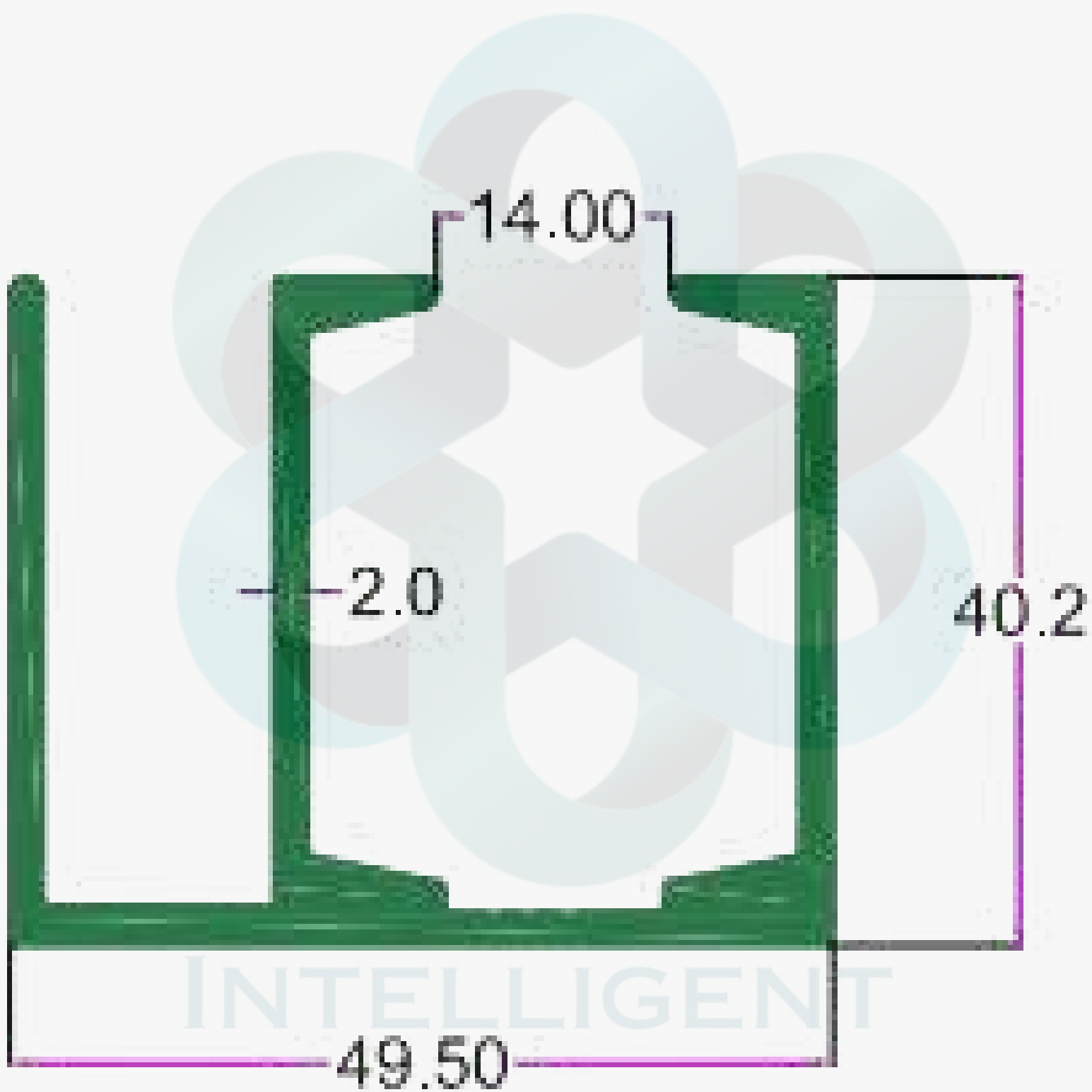

INTELLIGENT
ALUMINIUM

itswallpanel.com

SEC. NO. 3280

WT. 3.885 TO 4.300 KG/12'

SLIDING SERIES



INTELLIGENT
ALUMINIUM
itswallpanel.com

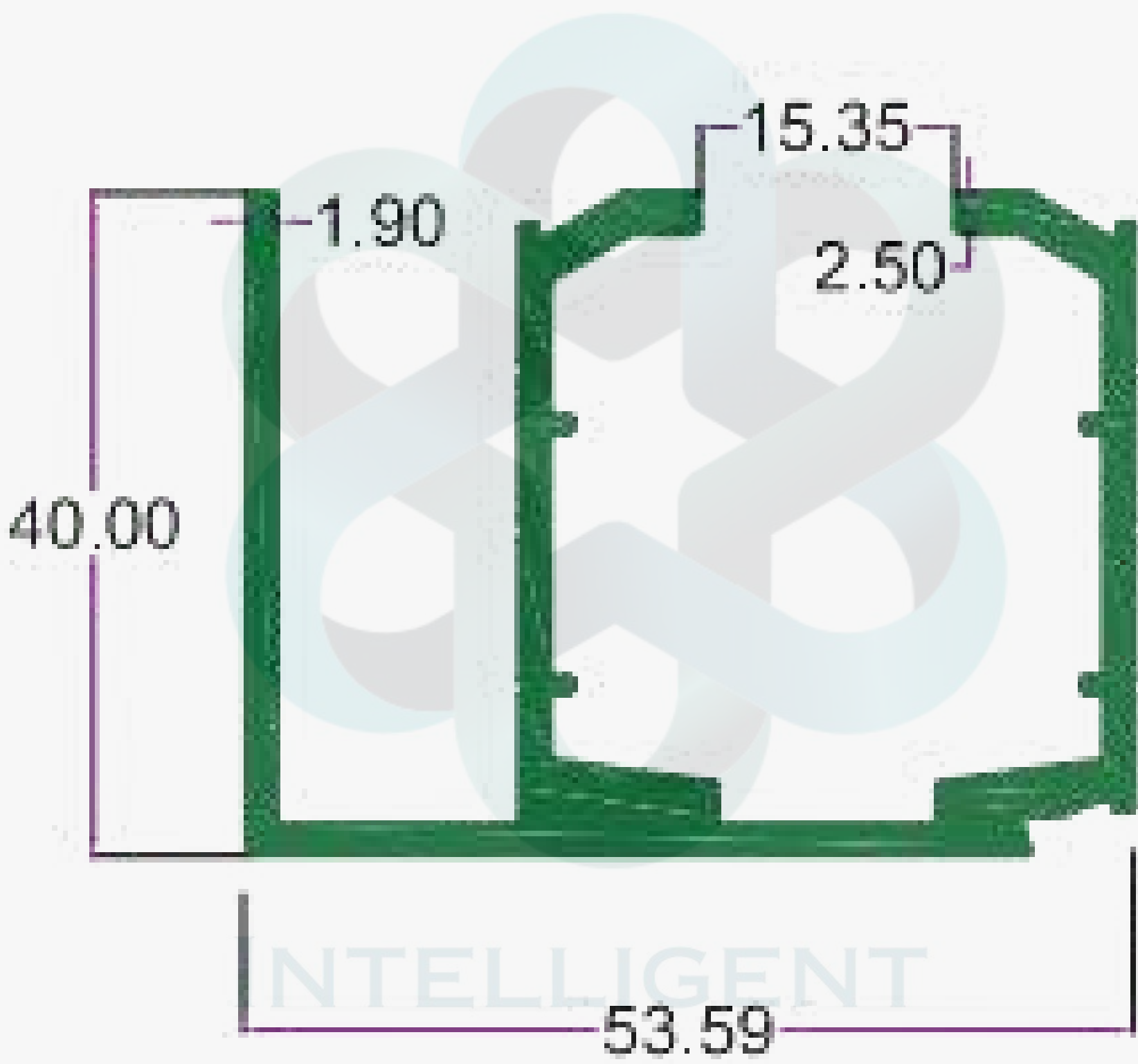

INTELLIGENT
ALUMINIUM

itswallpanel.com

SEC. NO. 4292

WT. 4.050 TO 4.250 KG/12'