

DOMAL /CASEMENT/MESH

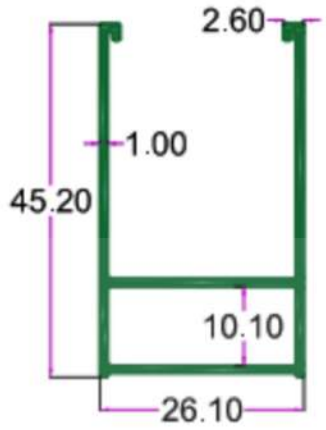

INTELLIGENT
ALUMINIUM
itswallpanel.com



SEC.NO. 4431
WT. 1.400 TO 1.600 KG/12'

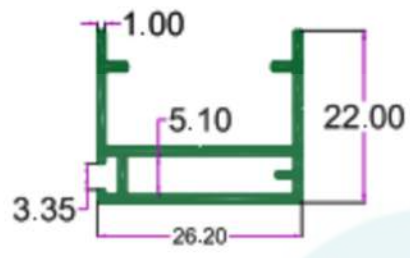

SEC.NO. 4433
WT. 1.000 TO 1.200 KG/12'

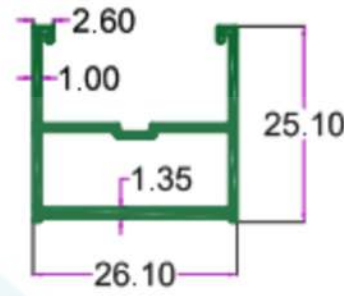

SEC.NO. 4432
WT. 1.100 TO 1.300 KG/12'

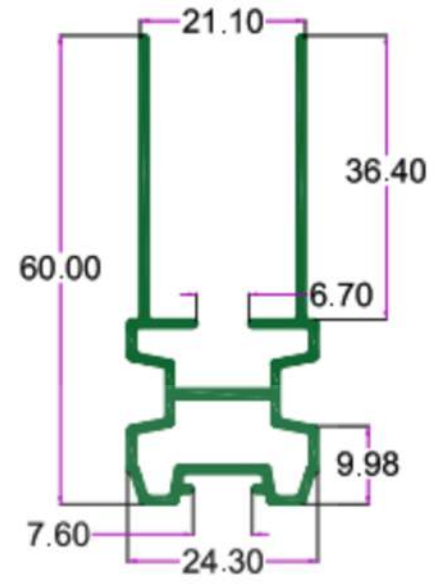

SEC.NO. 4434
WT. 1.930 TO 2.1500 KG/12'

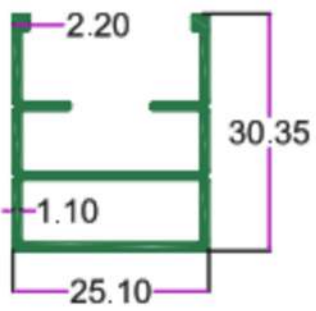

SEC.NO. 4776
WT. 1.290 TO 1.400 KG/12'

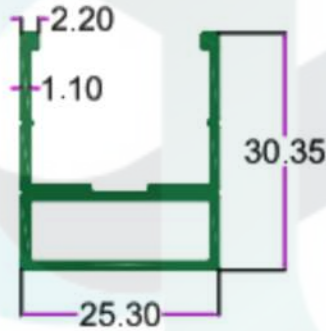

SEC.NO. 4777
WT. 1.340 TO 1.450 KG/12'

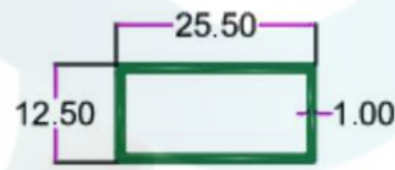

SEC.NO. 4779
WT. 0.700 TO 0.800 KG/12'

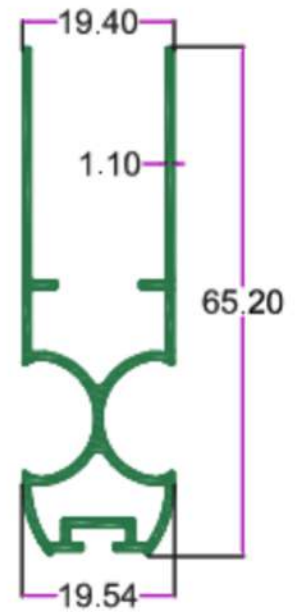

SEC.NO. 4778
WT. 2.000 TO 2.150 KG/12'

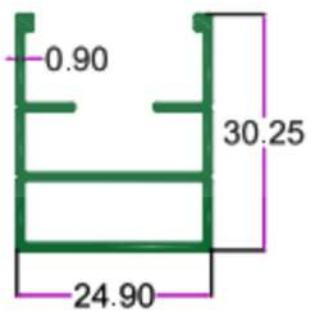

SEC.NO. 4992
WT. 1.110 TO 1.210 KG/12'

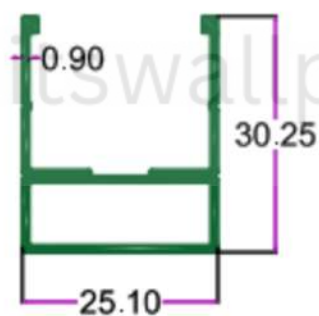

SEC.NO. 4993
WT. 1.125 TO 1.250 KG/12'

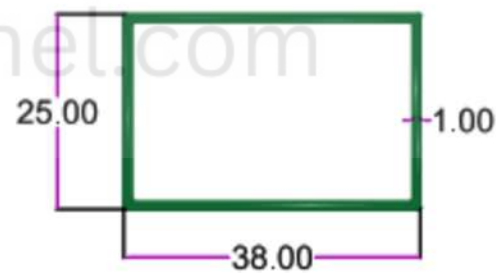

SEC.NO. 4995
WT. 1.200 TO 1.300 KG/12'

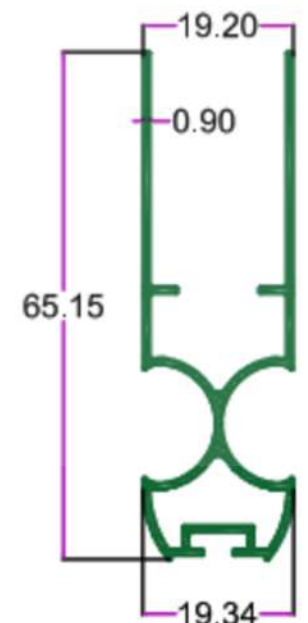

SEC.NO. 4994
WT. 1.635 TO 1.780 KG/12'

DOMAL /CASEMENT/MESH



INTELLIGENT
ALUMINIUM
itswallpanel.com

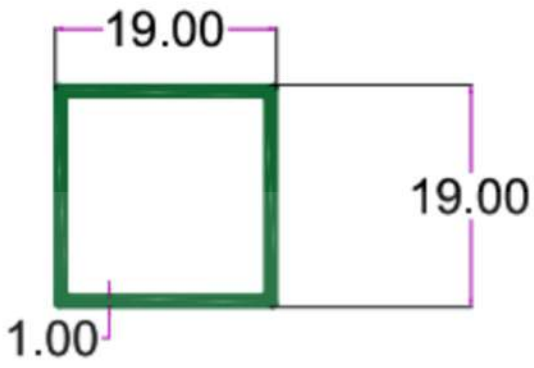

SEC.NO. 4346
WT. 0.700 TO 0.850 KG/12'

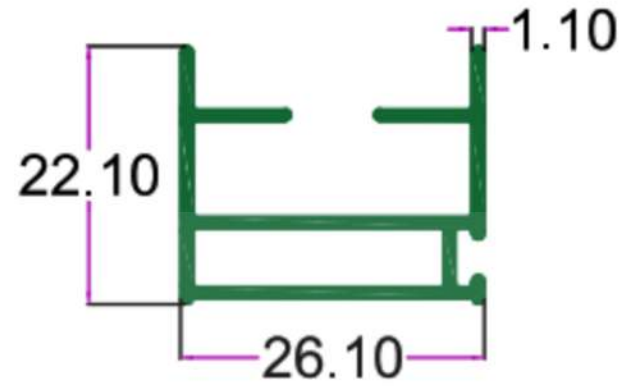

SEC.NO. 5106
WT. 1.130 TO 1.380 KG/12'

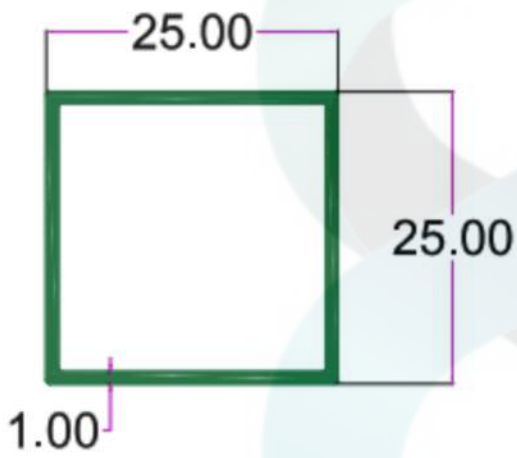

SEC.NO. 4347
WT. 0.900 TO 1.050 KG/12'

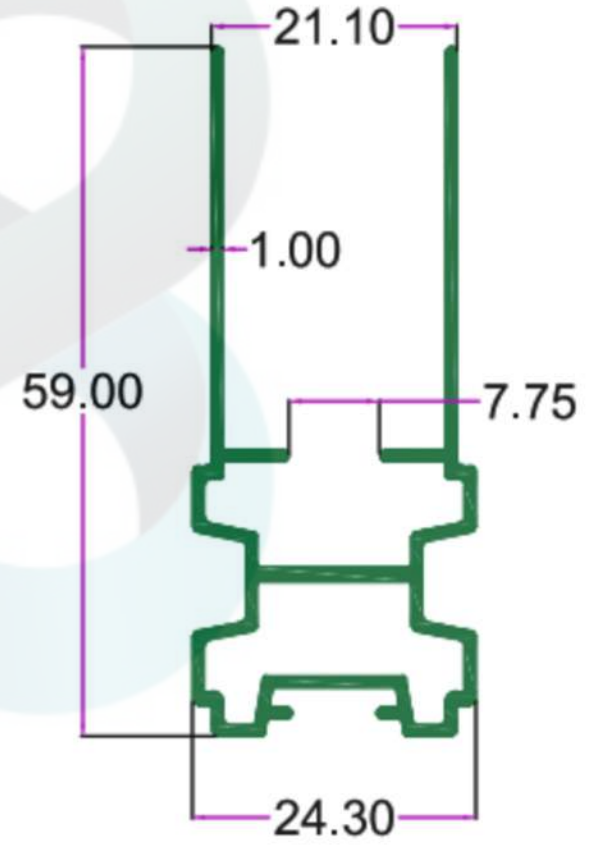

SEC.NO. 4813
WT. 1.950 TO 2.150 KG/12'

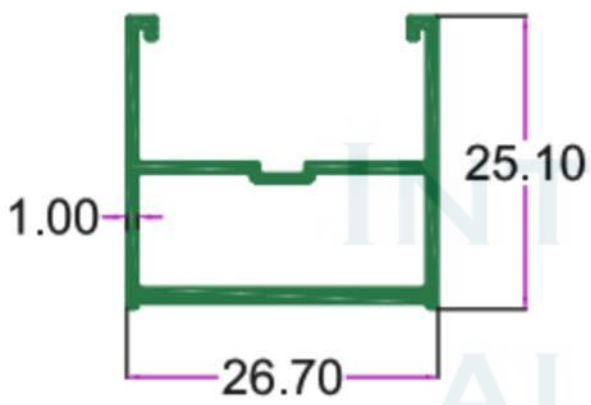

SEC.NO. 5214
WT. 1.280 TO 1.530 KG/12'

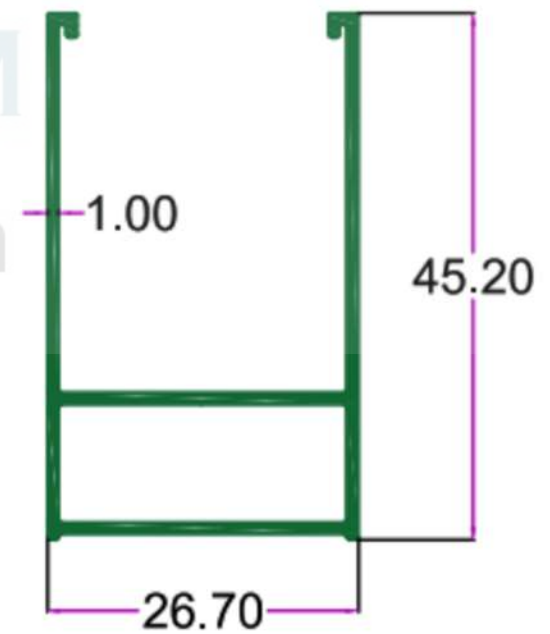

SEC.NO. 5215
WT. 1.430 TO 1.680 KG/12'

DOMAL /CASEMENT/MESH



INTELLIGENT
ALUMINIUM
itswallpanel.com

27MM SLIDING WINDOWS

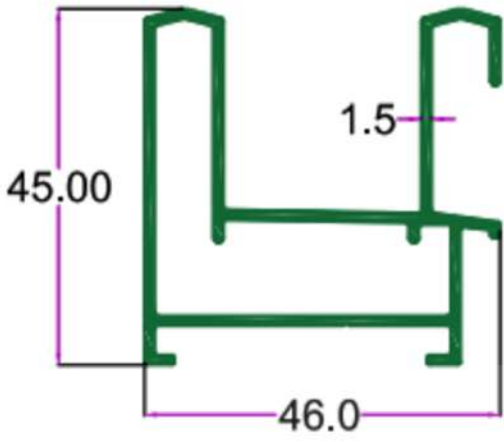

SEC. NO. 3313
WT. 3.270 TO 3.550 KG/12'

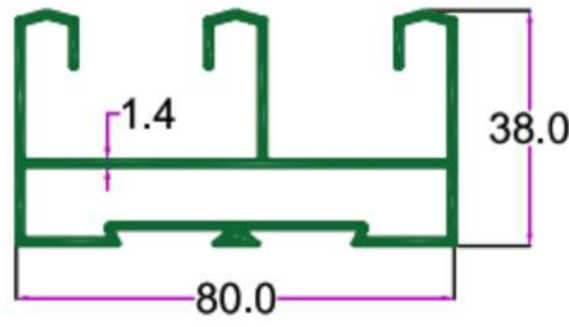

SEC. NO. 3316
WT. 4.290 TO 4.500 KG/12'

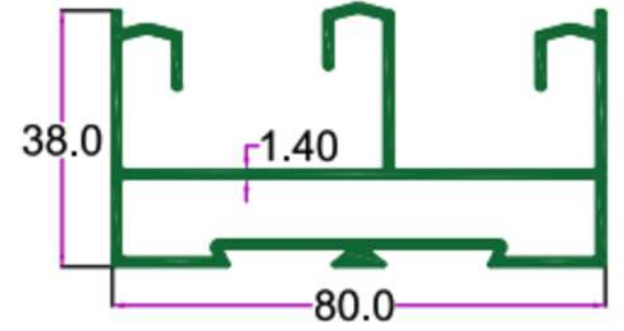

SEC. NO. 3314
WT. 4.30 TO 4.50 KG./ 12'

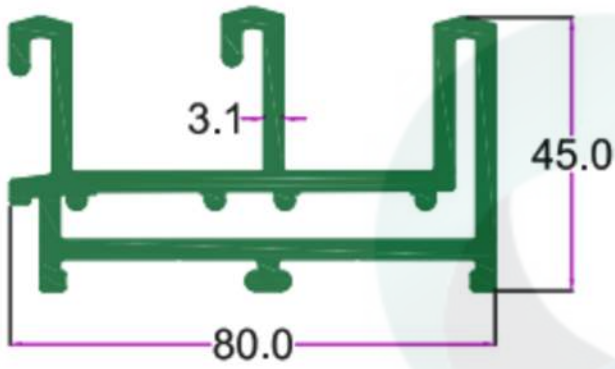

SEC. NO. 3694
WT. 9.60 TO 10.60 KG/12'

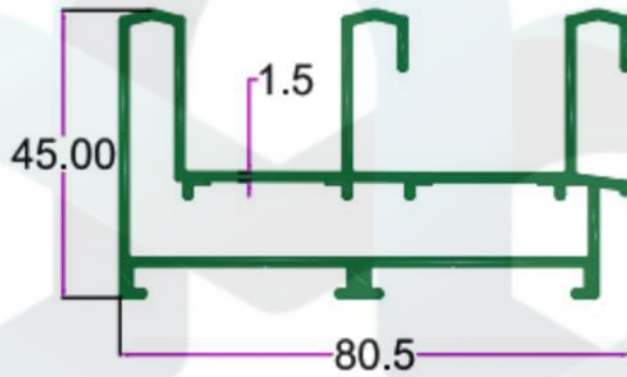

SEC. NO. 3311
WT. 5.200 TO 5.400 KG/12'

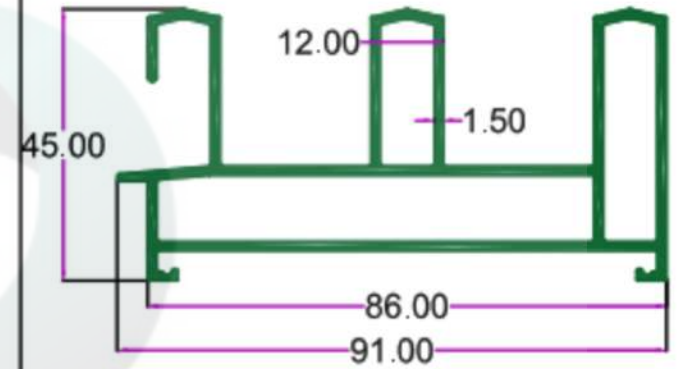

SEC. NO. 4272
WT. 5.750 TO 6.100 KG/12'

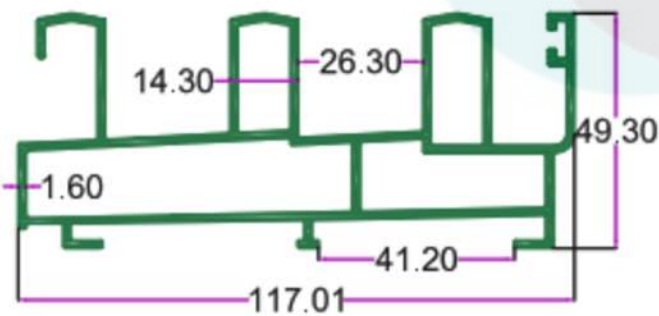

SEC. NO. 3320
WT. 8.000 TO 8.250 KG/12'



SEC. NO. 3315
WT. 2.720 TO 3.000 KG./12'

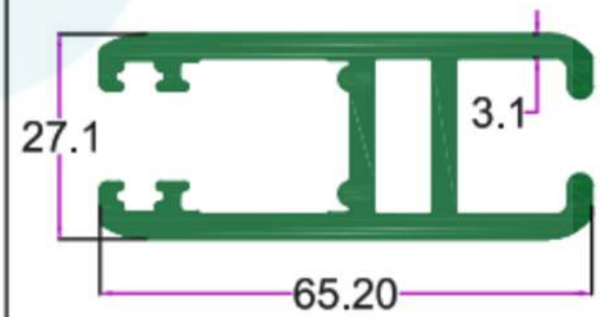

SEC. NO. 3695
WT. 5.750 TO 6.100 KG/12'

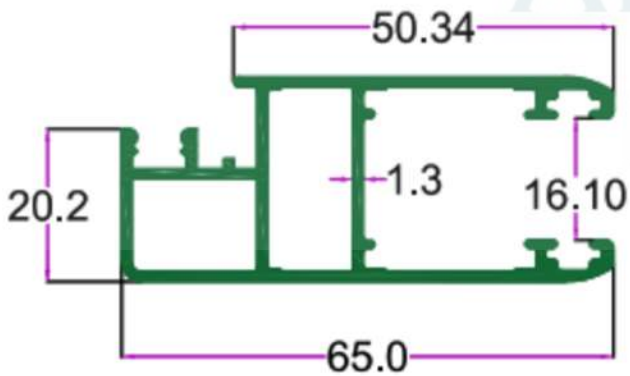

SEC. NO. 3331
WT. 3.100 TO 3.400 KG/12'

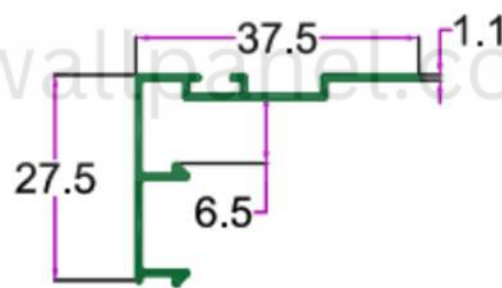

SEC. NO. 3312
WT. 0.940 TO 1.110 KG./12'

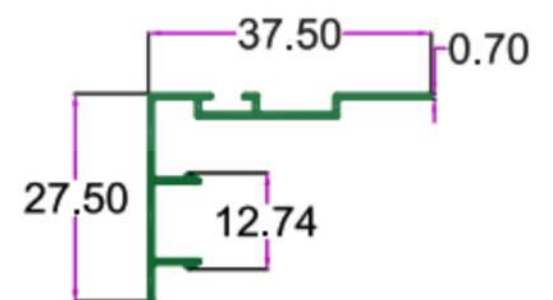

SEC. NO. 4421
WT. 0.600 TO 0.850 KG/12'



27MM SLIDING WINDOWS

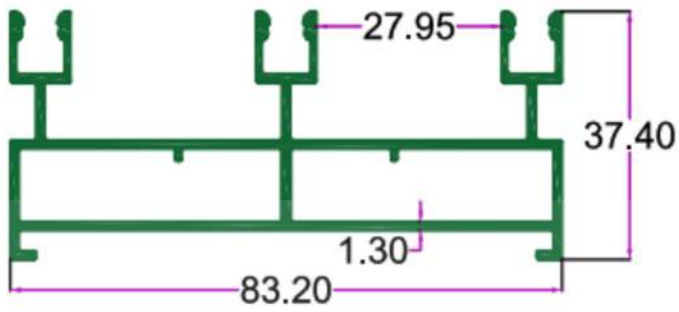

SEC.NO. 5121
WT. 2.810 TO 3.060 KG/12'

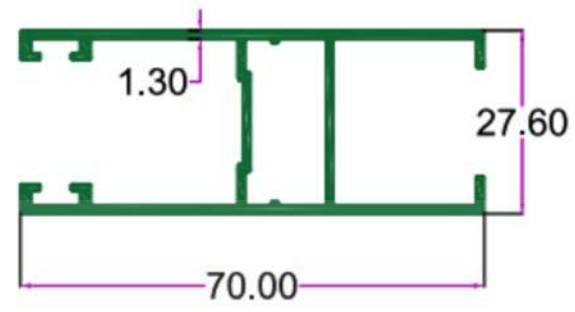

SEC.NO. 5120
WT. 2.810 TO 3.060 KG/12'

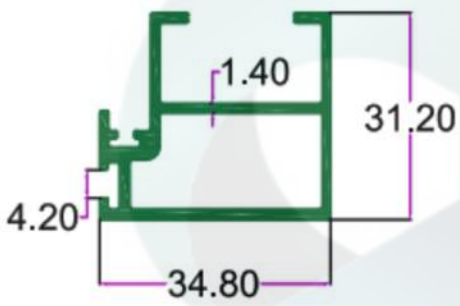

SEC.NO. 5123
WT. 2.110 TO 2.360 KG/12'

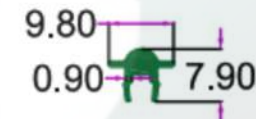

SEC.NO. 5122
WT. 0.245 TO 0.495 KG/12'

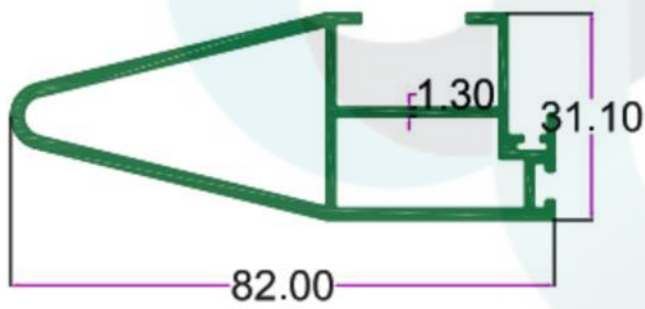

SEC.NO. 5119
WT. 3.915 TO 4.165 KG/12'

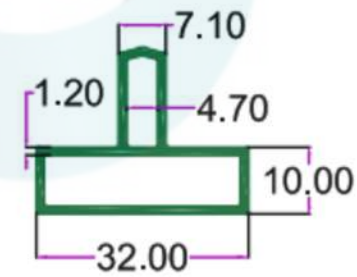

SEC.NO. 4277
WT. 1.440 TO 1.650 KG/12'

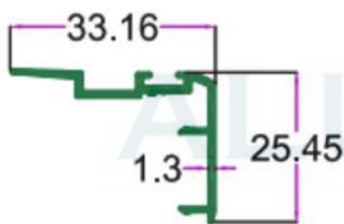

SEC.NO. 3336
WT. 0.690 TO 0.800 KG/12'

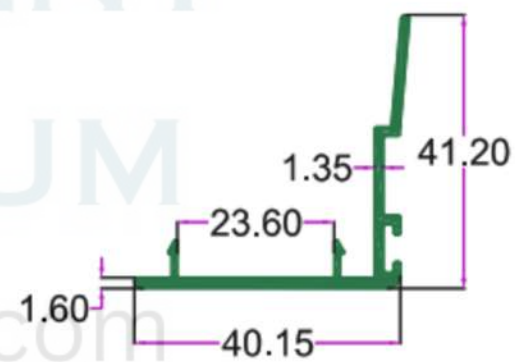

SEC.NO. 4997
WT. 1.375 TO 1.500 KG/12'



37MM SLIDING WINDOWS

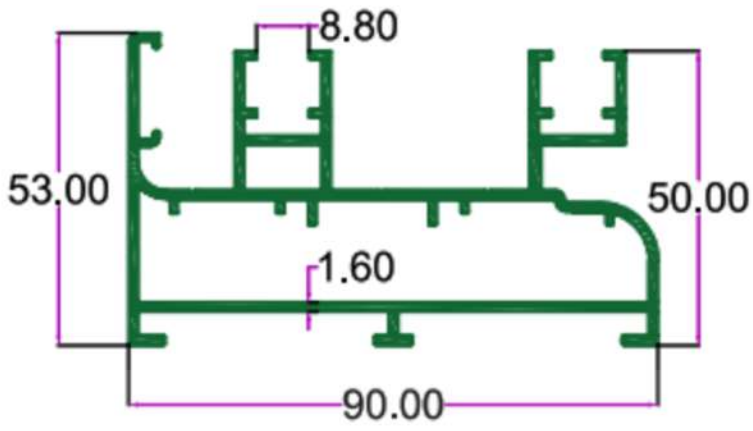

SEC. NO. 4706
WT. 6.700 TO 6.950 KG/I2'

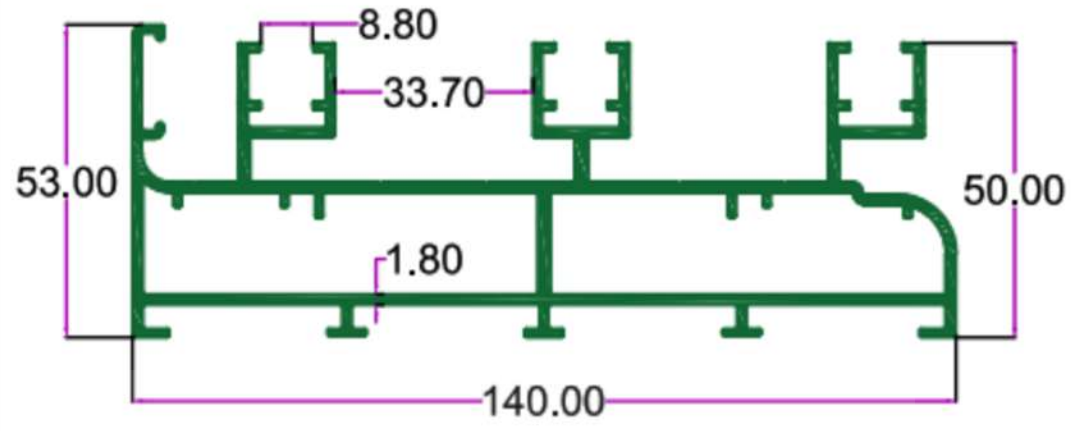

SEC. NO. 4707
WT. 10.540 TO 10.800 KG/I2'

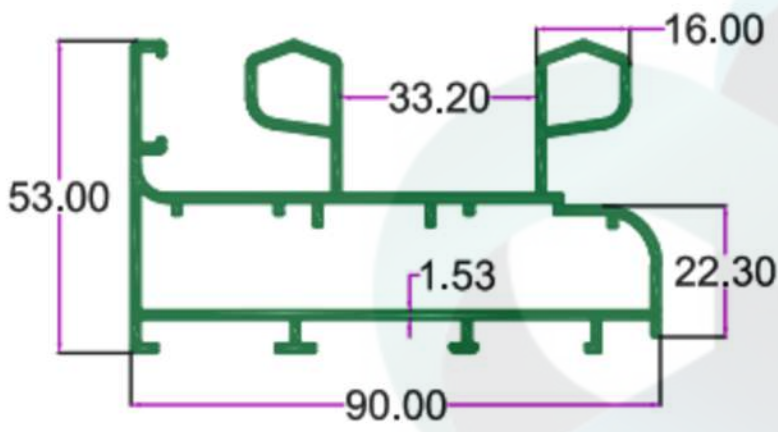

SEC. NO. 4712
WT. 6.440 TO 6.620 KG/I2'

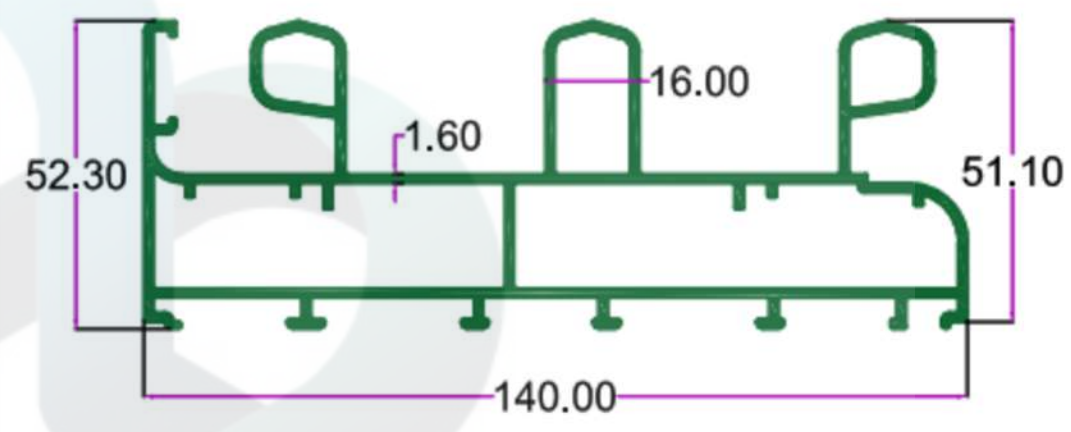

SEC. NO. 4713
WT. 9.810 TO 10.120 KG/I2'

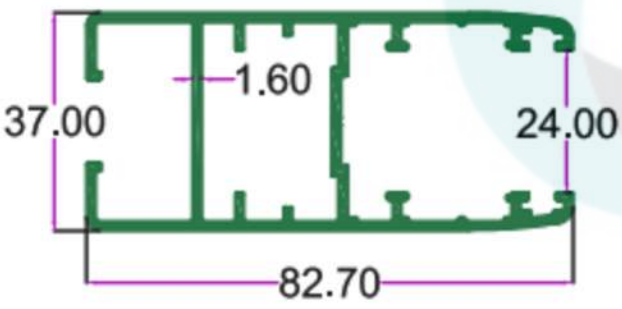

SEC. NO. 4708
WT. 4.860 TO 5.050 KG/I2'

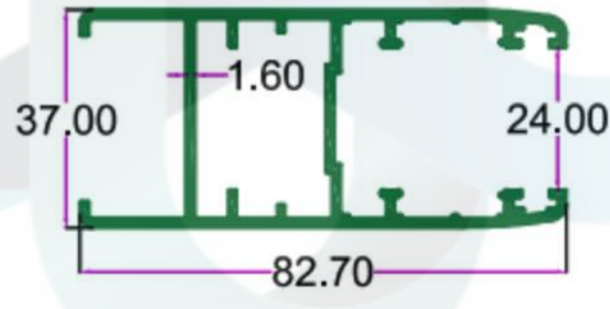

SEC. NO. 4709
WT. 4.610 TO 4.850 KG/I2'

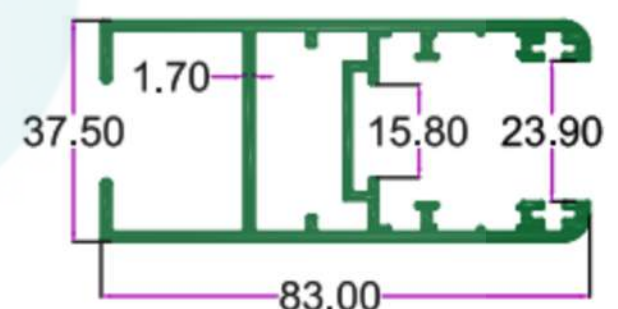

SEC. NO. 4748
WT. 5.240 TO 5.500 KG/I2'

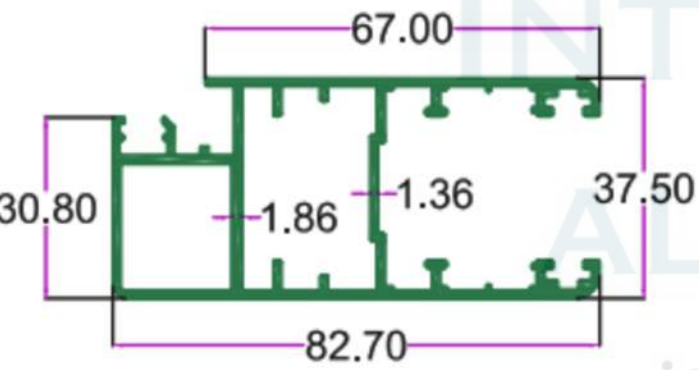

SEC. NO. 4711
WT. 4.820 TO 5.050 KG/I2'

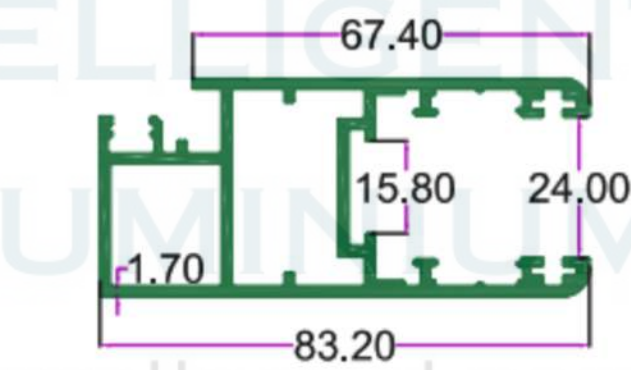

SEC. NO. 4747
WT. 5.700 TO 5.950 KG/I2'

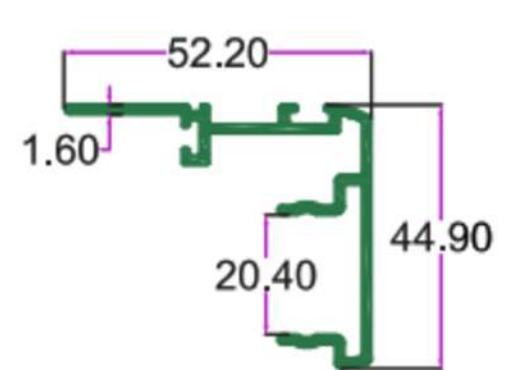

SEC. NO. 4710
WT. 2.420 TO 2.610 KG/I2'

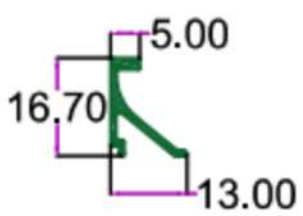

SEC. NO. 4717
WT. 0.420 TO 0.550 KG/I2'

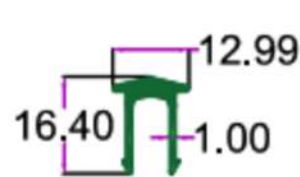

SEC. NO. 4705
WT. 0.550 TO 0.650 KG/I2'

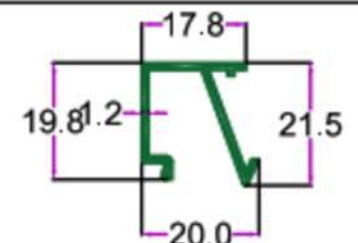

SEC. NO. 3340
WT. 0.70 TO 0.850 KG/I2'



29MM SLIDING WINDOWS

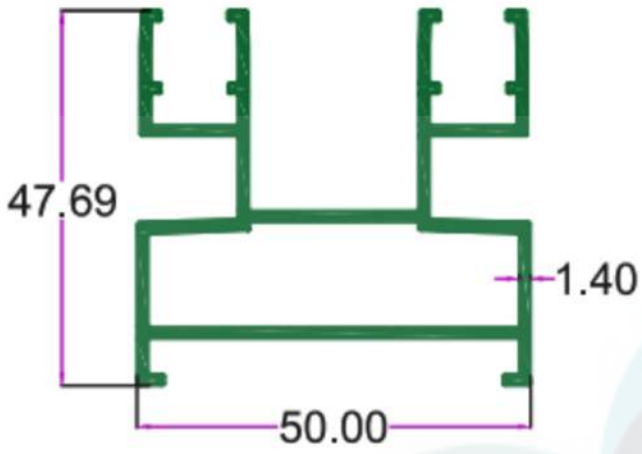

SEC.NO. 4928
WT. 3.600 TO 3.900 KG./ 12'

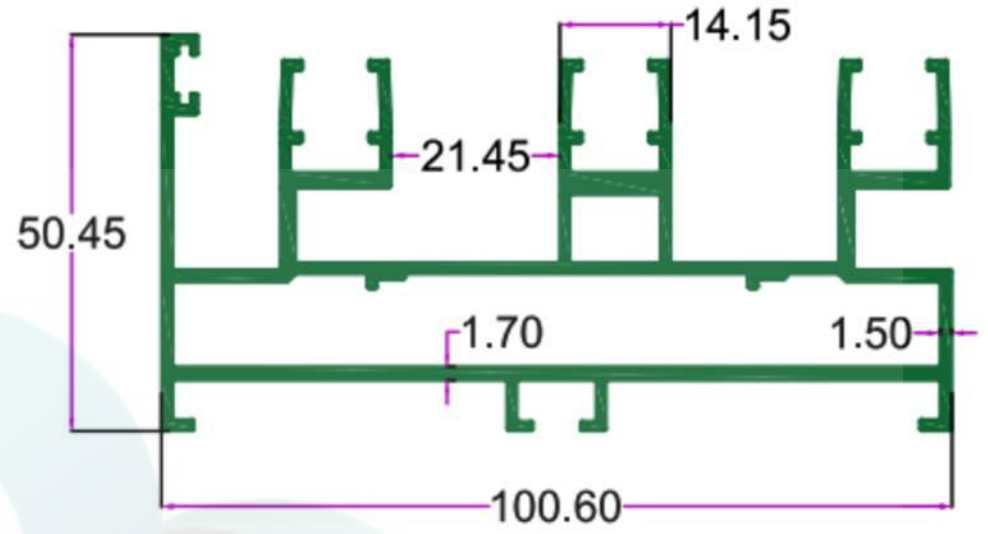

SEC.NO. 4927
WT. 7.615 TO 7.915 KG./ 12'

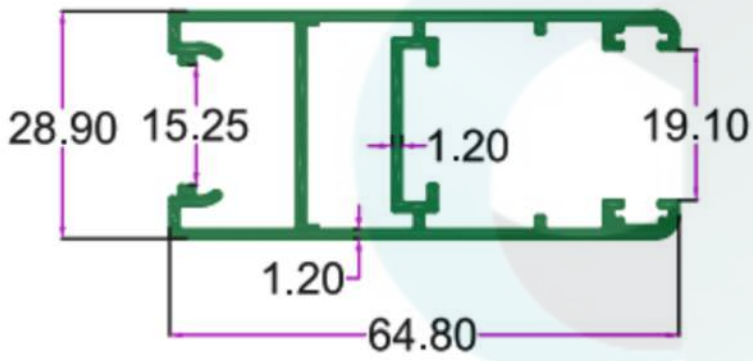

SEC.NO. 4924
WT. 2.990 TO 3.300 KG/12'

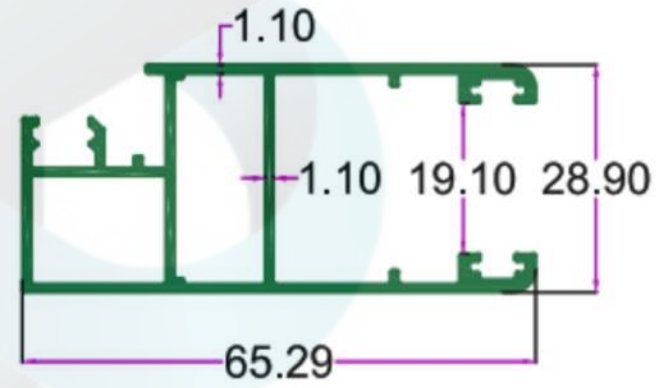

SEC.NO. 4925
WT. 2.750 TO 3.050 KG/12'

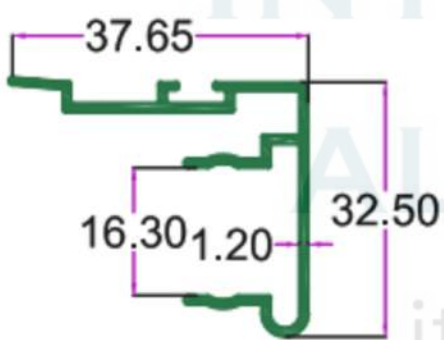

SEC.NO. 4926
WT. 1.310 TO 1.450 KG/12'

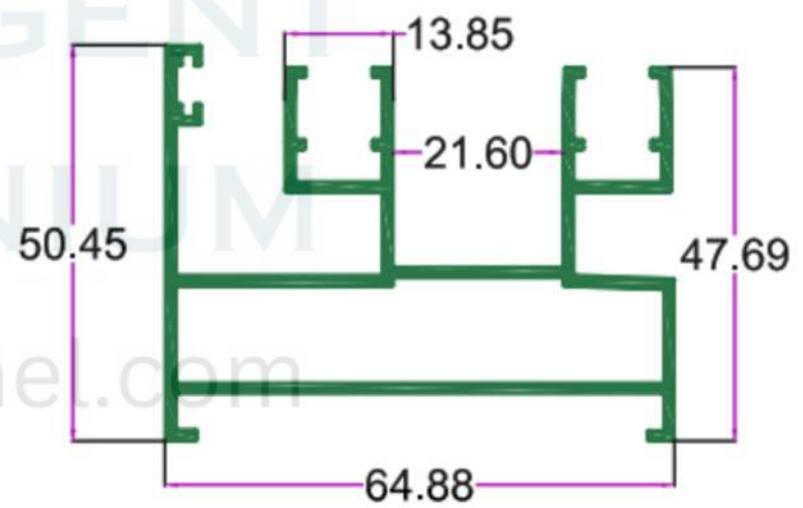

SEC.NO. 5152
WT. 4.600 TO 4.800 KG/12'

DOMAL /CASEMENT/MESH



INTELLIGENT
ALUMINIUM
itswallpanel.com

32MM SLIDING WINDOWS

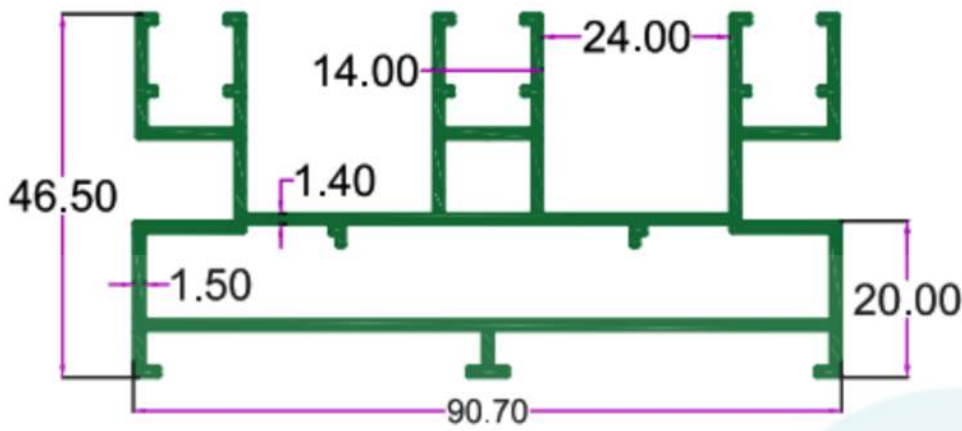

SEC.NO. 4888
WT. 5.900 TO 6.150 KG./ 12'

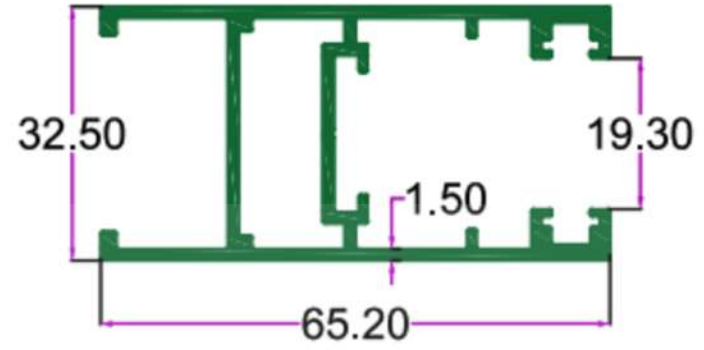

SEC.NO. 4889
WT. 3.700 TO 3.900 KG./ 12'

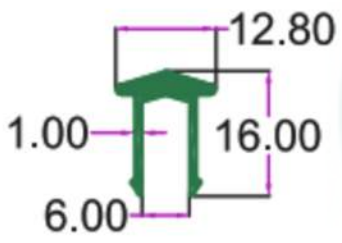

SEC.NO. 4890
WT. 0.555 TO 0.660 KG/12'

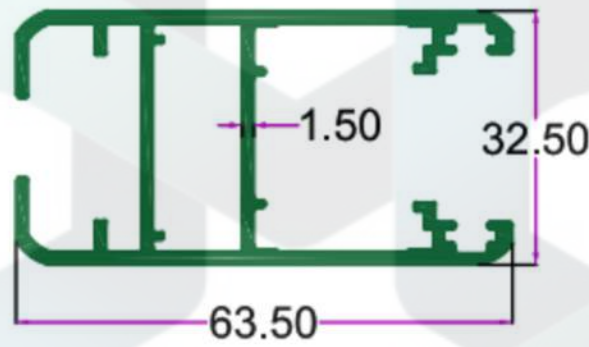

SEC.NO. 3319
WT. 3.850 TO 4.050 KG/12'

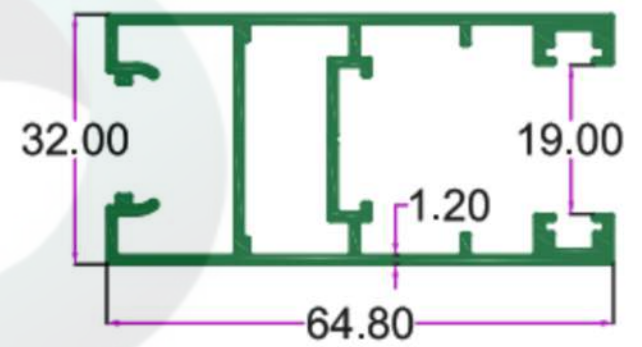

SEC.NO. 4892
WT. 3.360 TO 3.560 KG/12'

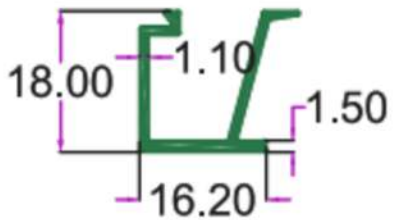

SEC.NO. 4893
WT. 0.580 TO 0.680 KG/12'

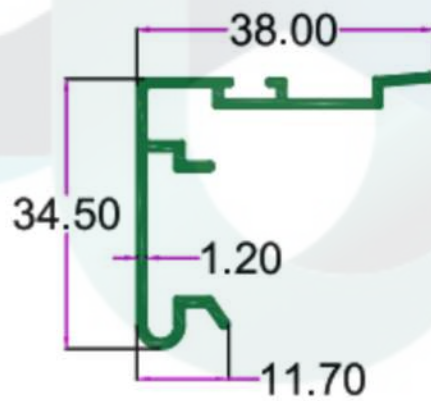

SEC.NO. 4891
WT. 1.230 TO 1.380 KG/12'

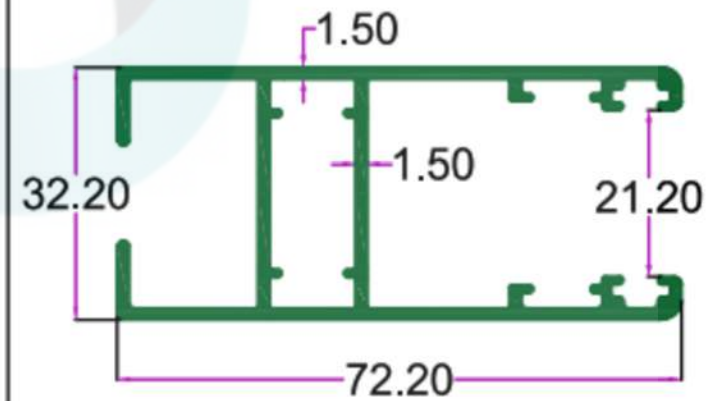

SEC.NO. 4351
WT. 3.760 TO 3.950 KG/12'

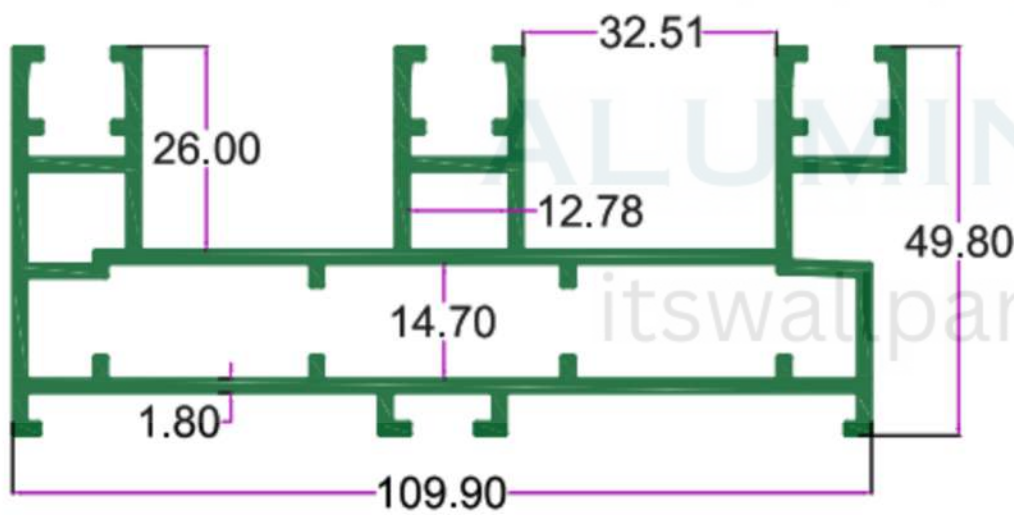

SEC.NO. 4740
WT. 9.020 TO 9.300 KG/12'

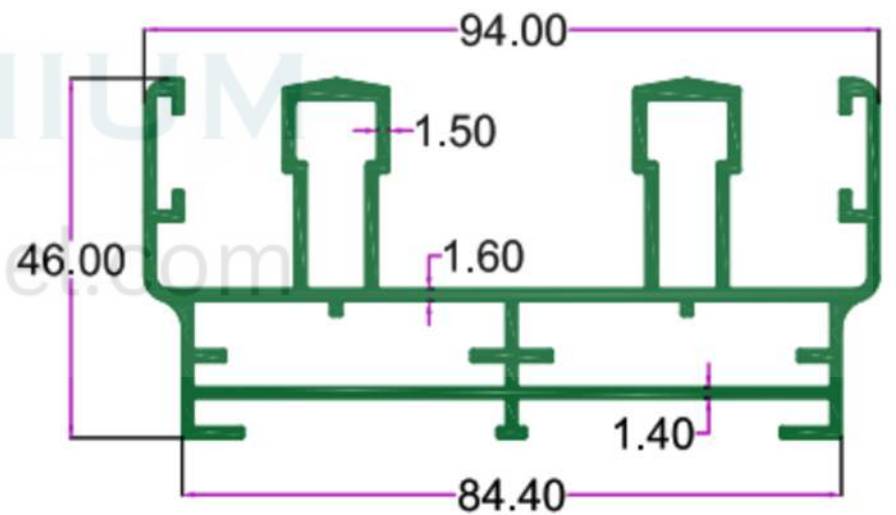

SEC.NO. 4345
WT. 7.100 TO 7.300 KG./ 12'



30MM CASEMENT SECTIONS

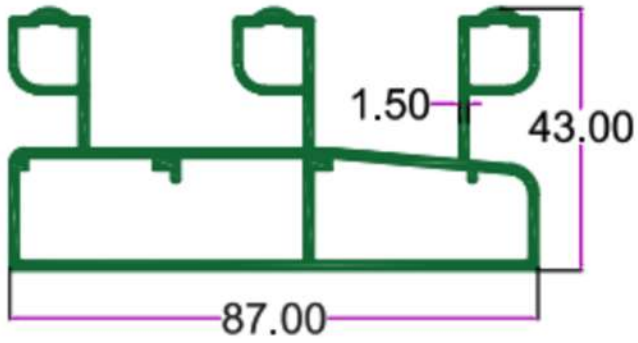

SEC. NO. 3977
WT. 5.700 TO 8.100 KG/12'

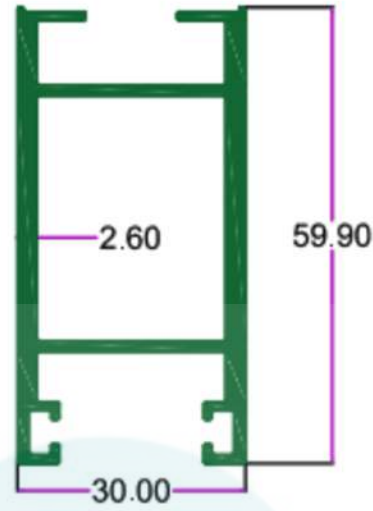

SEC. NO. 3991
WT. 3.900 TO 4.200 KG/12'

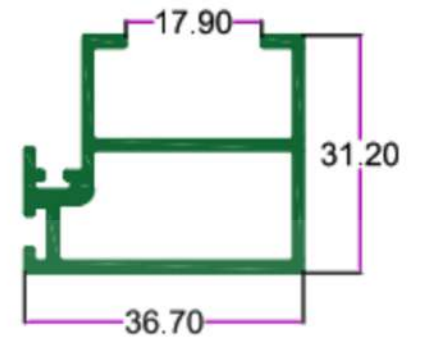

SEC. NO. 5153
WT. 2.170 TO 2.420 KG/12'

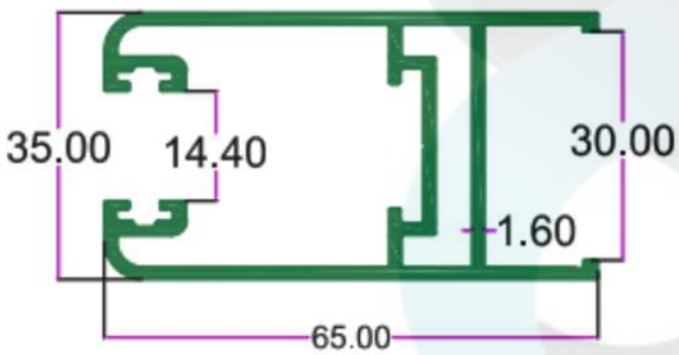

SEC. NO. 4797
WT. 3.950 TO 4.150 KG/12'

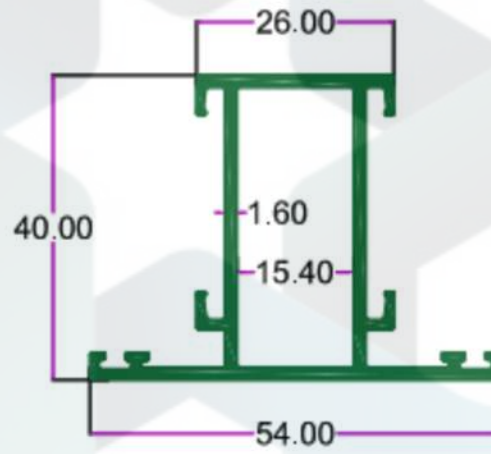

SEC. NO. 4766
WT. 2.800 TO 3.000 KG/12'

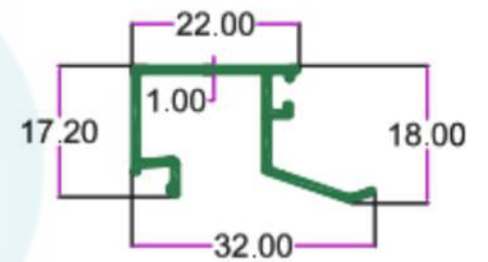

SEC. NO. 4767
WT. 0.760 TO 0.860 KG/12'

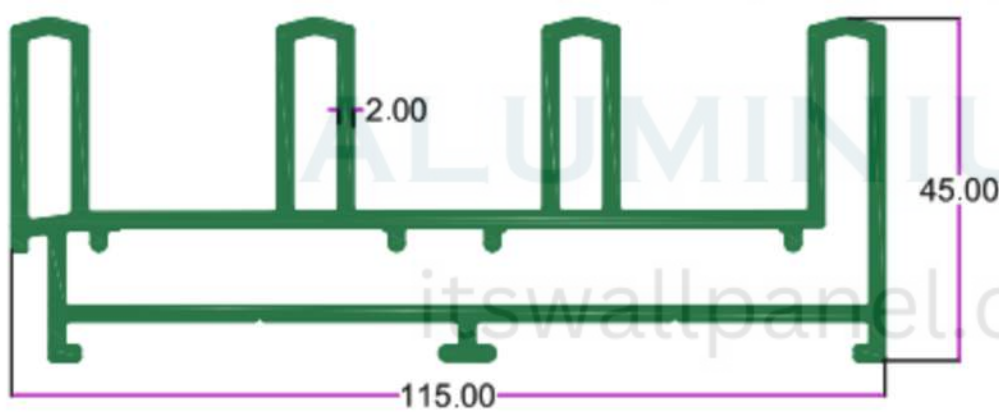

SEC. NO. 5131
WT. 9.870 TO 10.12 KG/12'

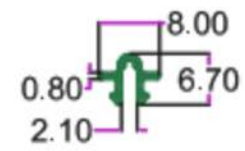

SEC. NO. 5037
WT. 0.140 TO 0.200 KG/12'



30MM CASEMENT SECTIONS

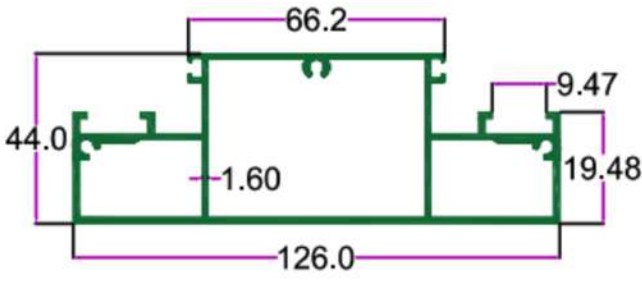

SEC. NO. 3527
WT. 7.100 TO 7.900 KG/12'

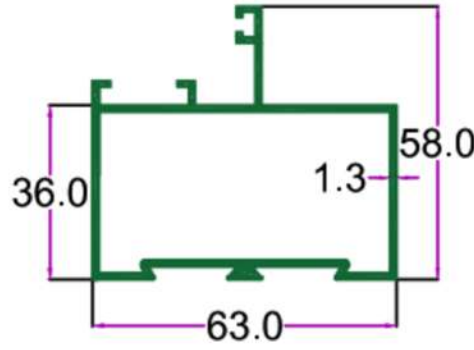

SEC. NO. 3530
WT. 3.100 TO 3.500 KG/12'

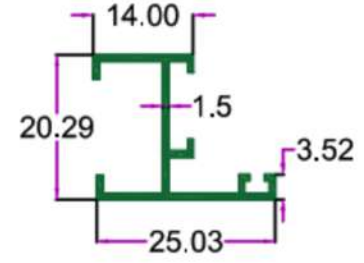

SEC. NO. 3522
WT. 1.550 TO 1.750 KG/12'

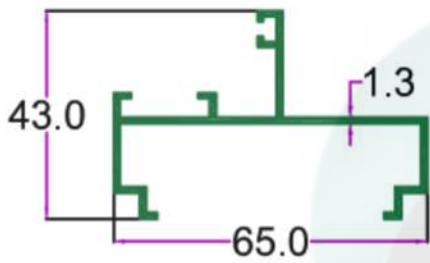

SEC. NO. 3528
WT. 2.050 TO 2.300 KG/12'

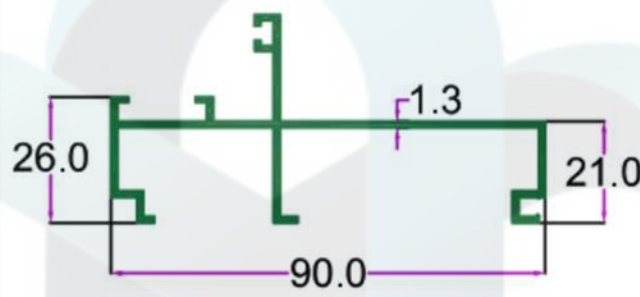

SEC. NO. 3529
WT. 2.700 TO 3.000 KG/12'

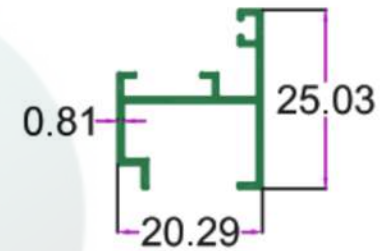

SEC. NO. 3994
WT. 1.300 TO 1.600 KG/12'

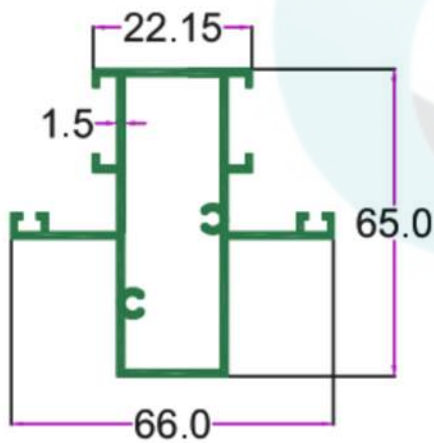

SEC. NO. 3531
WT. 3.800 TO 4.200 KG/12'

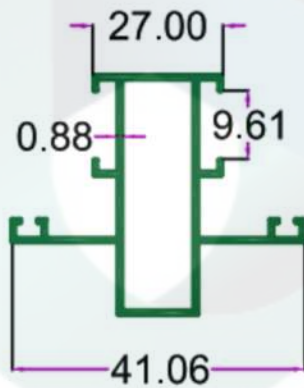

SEC. NO. 3521
WT. 3.000 TO 3.300 KG/12'

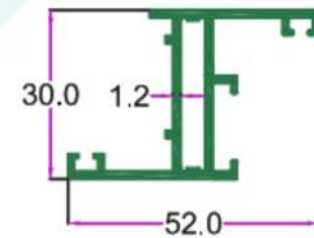

SEC. NO. 3525
WT. 1.650 TO 1.850 KG/12'

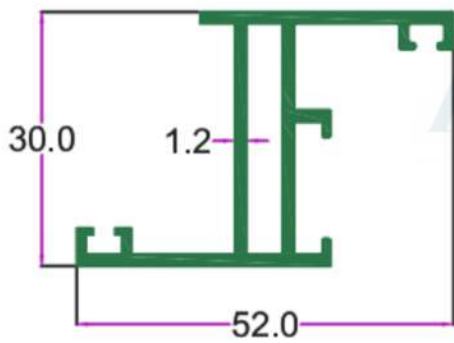

SEC. NO. 3523
WT. 1.650 TO 1.850 KG / 12'

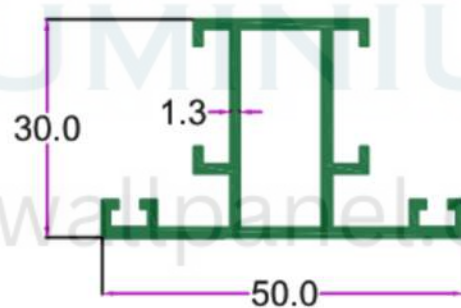

SEC. NO. 3524
WT. 1.900 TO 2.200 KG / 12'

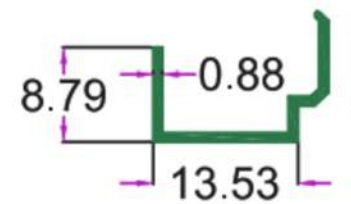

SEC. NO. 3526
WT. 0.630 TO 0.710 KG/12'



30MM CASEMENT SECTIONS

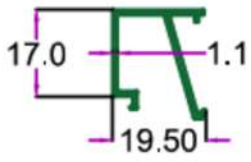

SEC. NO. 3518
WT. 0.700 TO 0.800 KG/12'

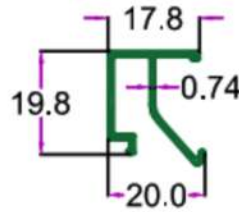

SEC. No. 3285
WT. 0.730 TO 0.850 KG/12'

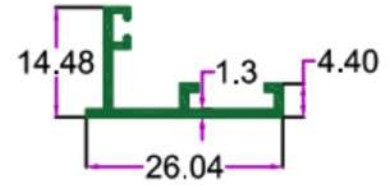

SEC. NO. 2065
WT. 1.000 TO 1.200 KG/12'

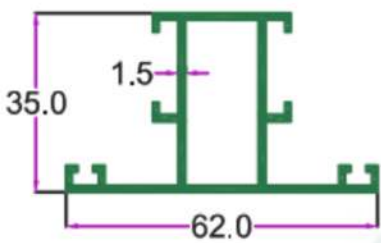

SEC. NO. 3515
WT. 2.300 TO 2.600 KG/12'

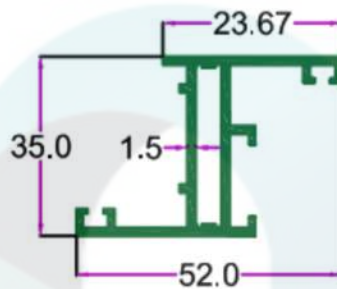

SEC. NO. 3516
WT. 2.200 TO 2.500 KG/12'

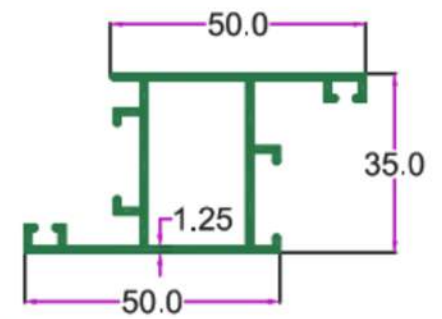

SEC. No. 3284
WT. 2.540 TO 2.800 KG/12'

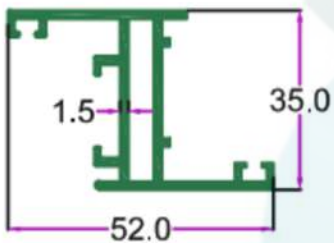

SEC. NO. 3517
WT. 2.300 TO 2.600 KG/12'

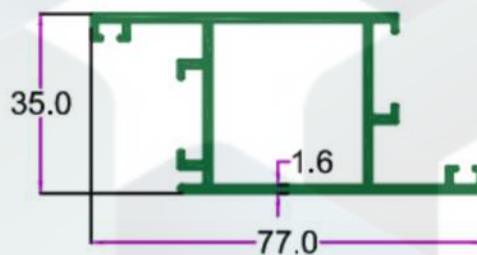

SEC. NO. 3520
WT. 3.100 TO 3.500 KG/12'

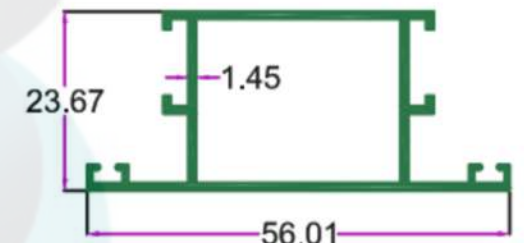

SEC. NO. 2066
WT. 3.400 TO 3.550 KG/12'

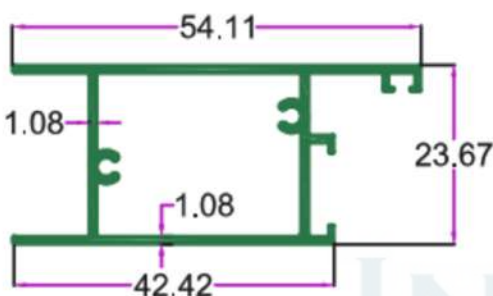

SEC. NO. 3519
WT. 3.600 TO 4.000 KG/12'

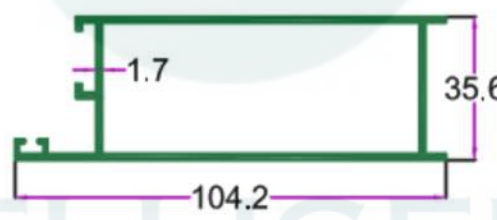

SEC. NO. 2064
WT. 4.647 TO 8.000 KG/12'

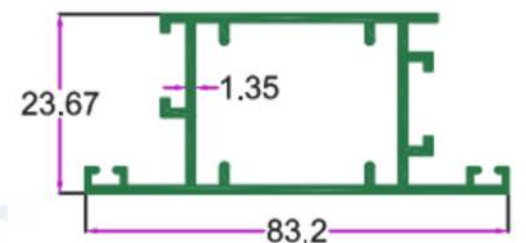

SEC. NO. 2067
WT. 3.622 TO 3.800 KG/12'

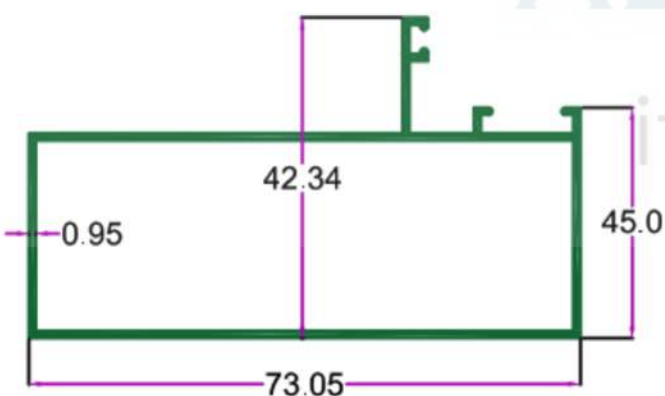

SEC. No. 3286
WT. 4.600 TO 4.900 KG/12'

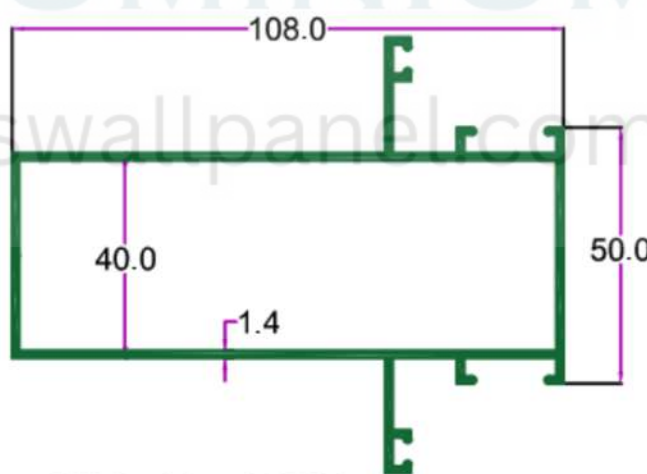

SEC. No. 3287
WT. 5.240 TO 5.500 KG/12'

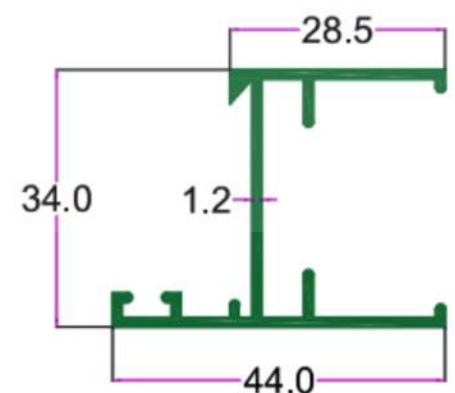

SEC. No. 3372
WT. 1.550 TO 1.850 KG/12'



38MM CASEMENT SECTIONS

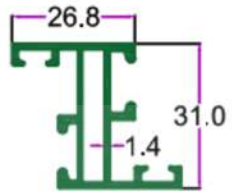

SEC. NO. 2180
WT. 1.900 TO 2.000 KG/12'

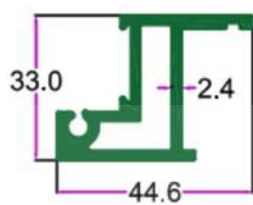

SEC. No. 3154
WT. 3.200 TO 3.540 KG/12'

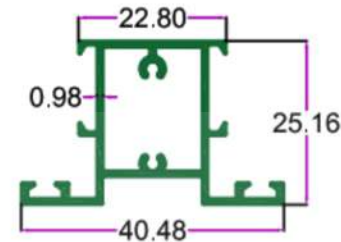

SEC. NO. 3263
WT. 2.906 TO 3.212 KG/12'

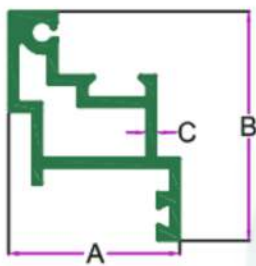

S. No.	Section No.	A IN mm.	B IN mm.	T IN mm.	Weight. (KG / 12')
1	2183	44.0	45.6	1.20	2.500-3.000
2	2184	44.0	45.6	1.80	2.500-3.000

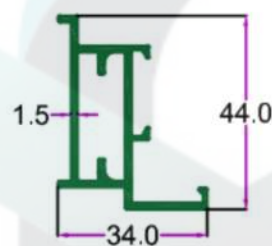

SEC. NO. 3261
WT. 2.026 TO 2.400 KG/12'

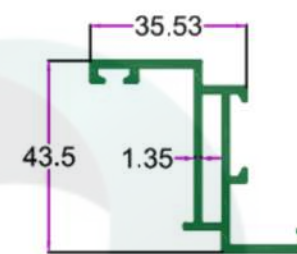

SEC. NO. 3262
WT. 2.070 TO 2.300 KG/12'

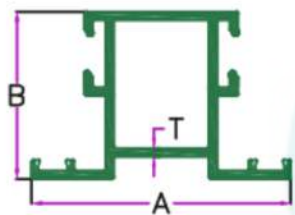

MULLION SECTION

S. No.	Section No.	A IN mm.	B IN mm.	T IN mm.	Weight. (KG / 12')
1	2101	59.00	38.00	1.40	2.500-2.700
2	2102	59.00	38.00	1.60	2.800-3.100
3	2103	59.00	38.00	1.85	3.200-3.700
4	2104	59.00	38.00	2.00	3.800-4.400

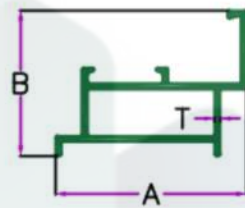

Z LINE SECTION

S. No.	Section No.	A IN mm.	B IN mm.	T IN mm.	Weight. (KG / 12')
1	2105	43.50	33.00	1.30	1.700-2.000
2	2106	43.50	33.00	1.55	2.100-2.300
3	2107	43.50	33.00	1.80	2.400-2.700
4	2108	43.50	33.00	2.10	3.000-3.500

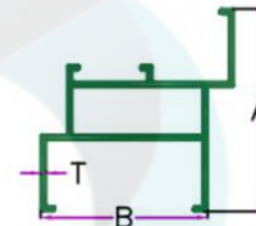

Z BOX SECTION

S. No.	Section No.	A IN mm.	B IN mm.	T IN mm.	Weight. (KG / 12')
1	2113	46.00	38.00	1.20	1.800-2.000
2	2114	46.00	38.00	1.40	2.100-2.300
3	2115	46.00	38.00	1.60	2.400-2.700

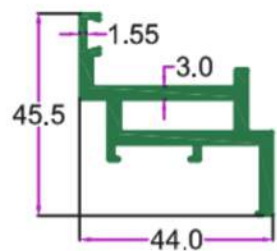

SEC. NO. 2118
WT. 3.900 TO 4.100 KG/12'

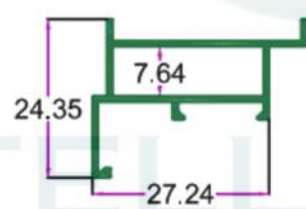

SEC. NO. 2116
WT. 1.800 TO 2.000 KG/12'

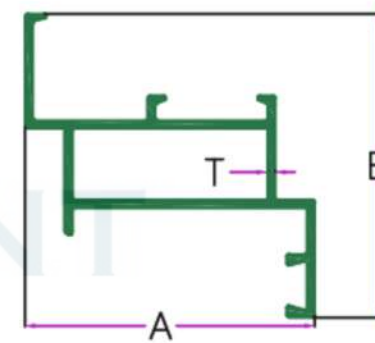

Z HOLLOW SECTION

S. No.	Section No.	A IN mm.	B IN mm.	T IN mm.	Weight. (KG / 12')
1	2109	44.00	46.00	1.20	1.800-2.000
2	2110	44.00	46.00	1.40	2.100-2.300
3	2111	44.00	46.00	1.60	2.400-2.700
4	2112	44.00	46.00	1.80	3.200-3.500
5	2119	44.00	46.00	1.10	1.600-1.800
6	3262	43.50	49.10	1.35	2.070-2.300

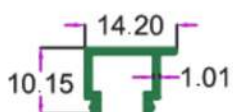

SEC. NO. 2117
WT. 0.400 TO 0.600 KG/12'

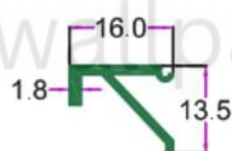

SEC.NO. 3335
WT. 2.500 TO 2.700 KG/12'

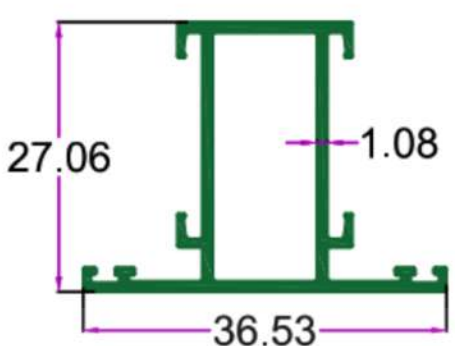
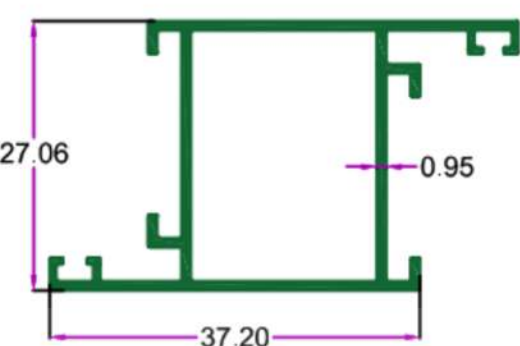
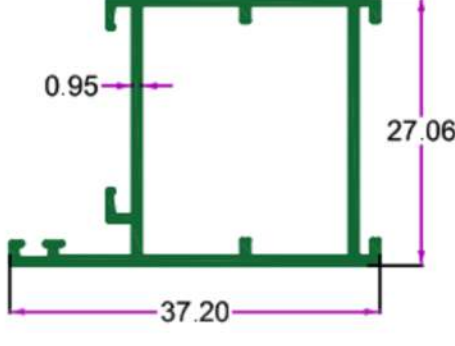
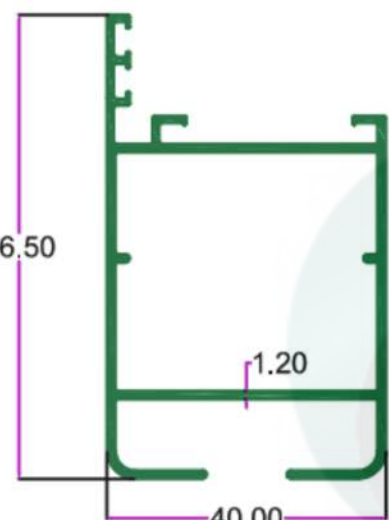
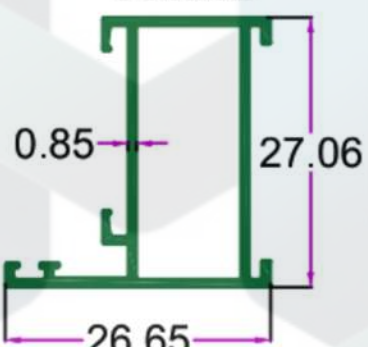
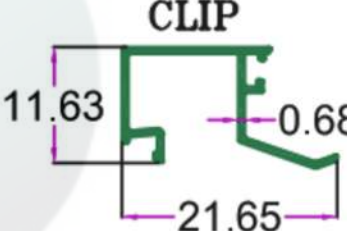
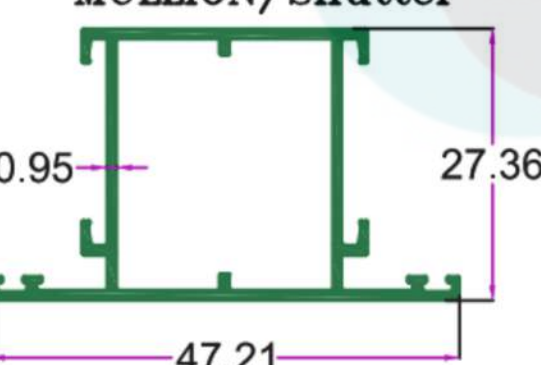
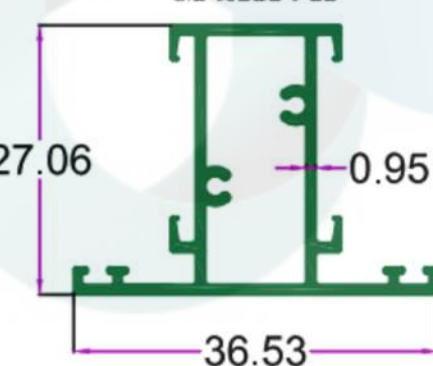
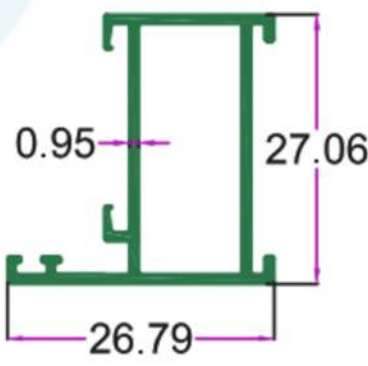
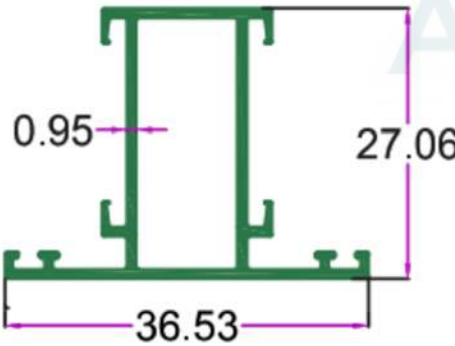
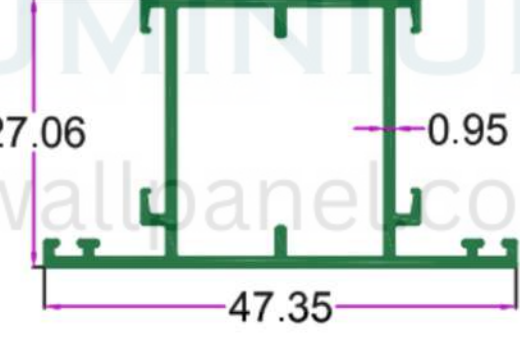
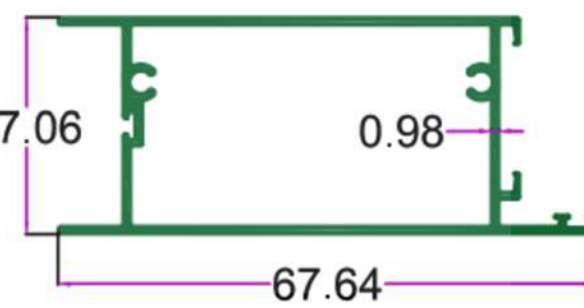

40MM CASEMENT SECTIONS

<p>Shutter</p>  <p>SEC.NO. 3332N / 4766 WT. 2.800 To 3.000 KG/12'</p>	<p>Z-MULLION</p>  <p>SEC.NO. 3339 WT. 3.050 To 3.250 KG/12'</p>	<p>DOOR FRAME</p>  <p>SEC.NO. 3334N WT. 2.650 To 2.850 KG/12'</p>
 <p>SEC. NO. 3464 WT. 3.500 TO 3.400 KG/12'</p>	<p>FRAME</p>  <p>SEC.NO. 3337N WT. 2.000 To 2.200 KG/12'</p>	<p>CLIP</p>  <p>SEC.NO. 334IN WT. 0.750 To 0.850 KG/12'</p>
<p>MULLION/Shutter</p>  <p>SEC.NO. 3338N WT. 3.300 To 3.500 KG/12'</p>	<p>Mullion</p>  <p>SEC. NO. 3481 WT. 2.600 TO 2.900 KG/12'</p>	<p>FRAME</p>  <p>SEC. NO. 3482 WT. 2.100 TO 2.400 KG/12'</p>
<p>Shutter</p>  <p>SEC. NO. 3483 WT. 2.350 TO 2.650 KG/12'</p>	<p>MULLION/Shutter</p>  <p>SEC. NO. 3484 WT. 3.950 TO 3.250 KG/12'</p>	<p>Door Bottom</p>  <p>SEC. NO. 3485 WT. 4.100 TO 4.600 KG/12'</p>



40MM CASEMENT SECTIONS

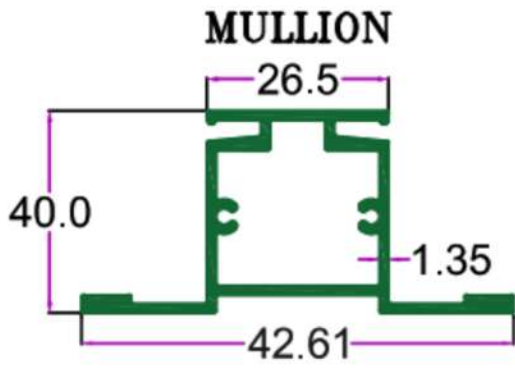

SEC. NO. 2051
WT. 3.900 TO 4.200 KG/15'

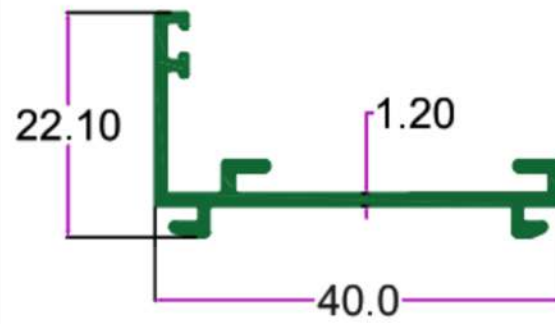

SEC. NO. 3463
WT. 0.920 TO 1.030 KG/12'

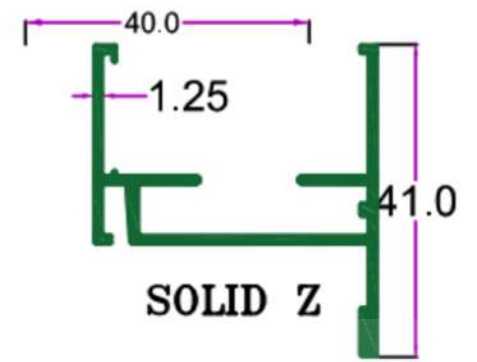

SEC. NO. 2053
WT. 1.700 TO 1.900 KG/12'

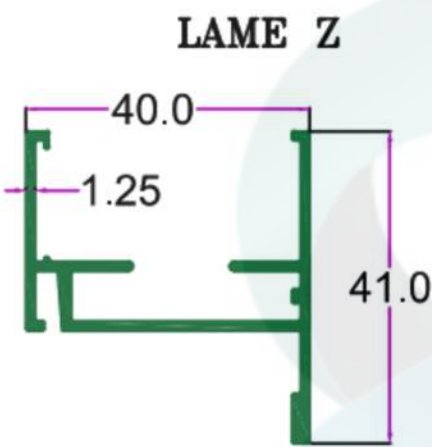

SEC. NO. 2054
WT. 2.900 TO 3.100 KG/15'

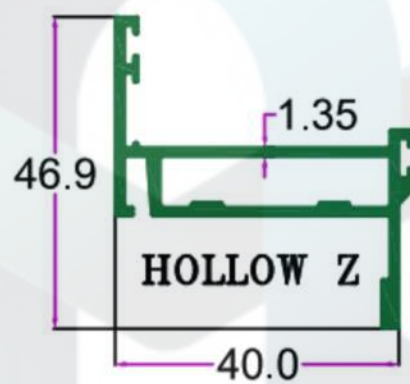

S. No.	Section No.	A IN mm.	B IN mm.	Weight. (KG./ 15')
1	2052 L	46.90	40.00	2.700-2.900
2	2052 M	46.90	40.00	3.400-3.600
3	2052 H	46.90	40.00	4.700-4.900

SEC. NO. 2055
WT. 0.900 TO 1.000 KG/15'

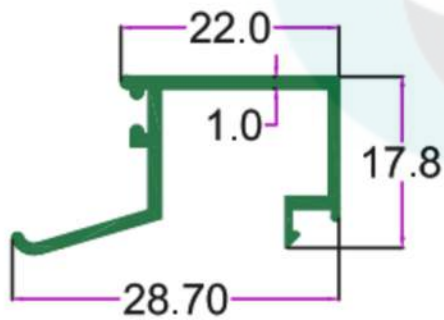
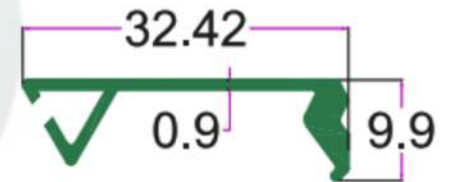

SEC. NO. 3465
WT. 0.680 TO 1.000 KG/12'

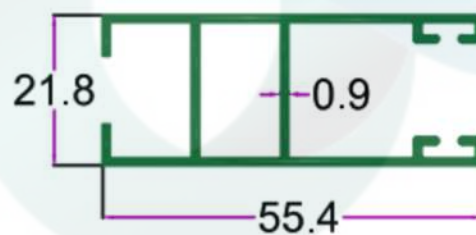

SEC. NO. 3333
WT. 2.800 TO 3.00 KG/12'

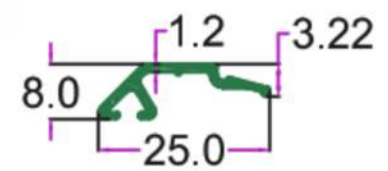

SEC. NO. 3460
WT. 0.450 TO 0.550 KG/12'

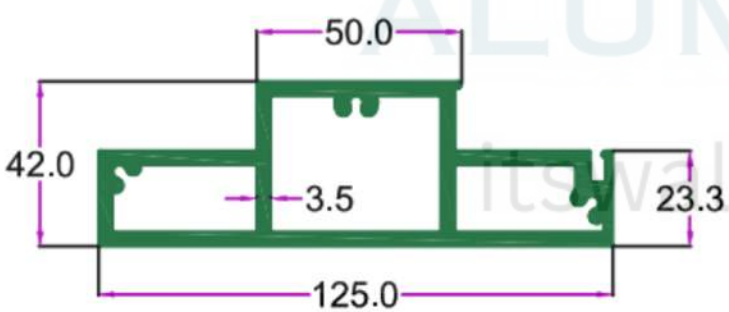

S. No.	Section No.	A IN mm.	B IN mm.	Weight. (KG./ 15')
1	2060	125	42.00	13.00-13.50
2	2069	125	42.00	9.800-10.50
3	3491	125	42.00	11.500-11.800

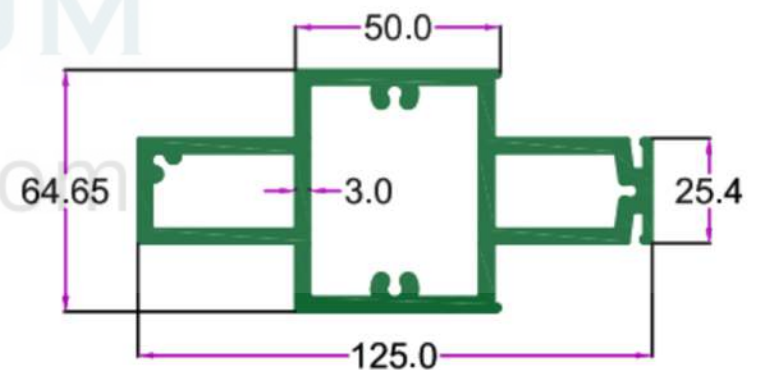

S. No.	Section No.	A IN mm.	B IN mm.	Weight. (KG./ 15')
1	2061	125	64.65	15.000-16.300
2	3492	125	64.65	11.600-11.900

40MM CASEMENT SECTIONS

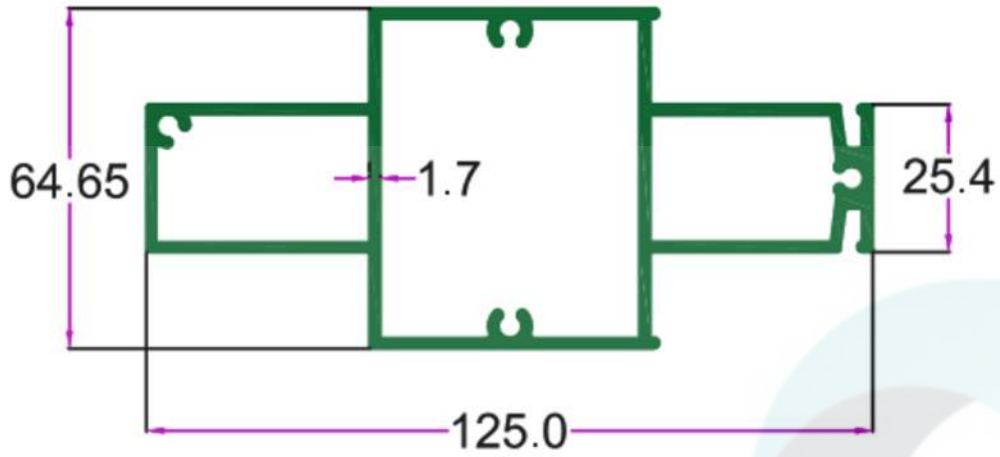

SEC. NO. 2062
WT. 7.800 TO 8.000 KG/12'

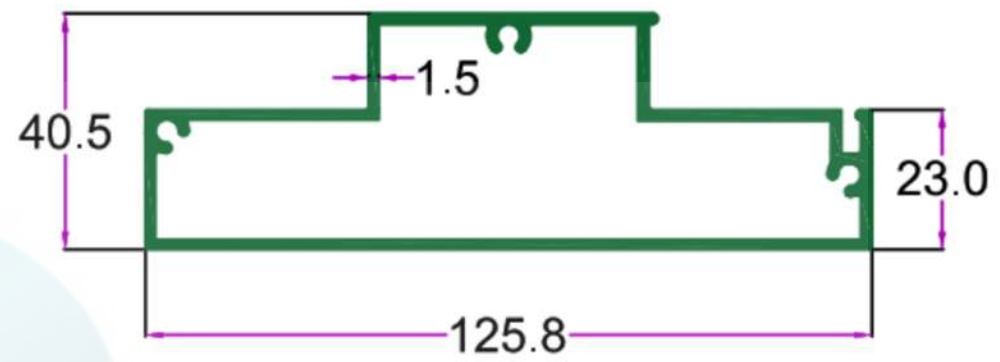

SEC. NO. 2063
WT. 5.260 TO 5.450 KG/12'

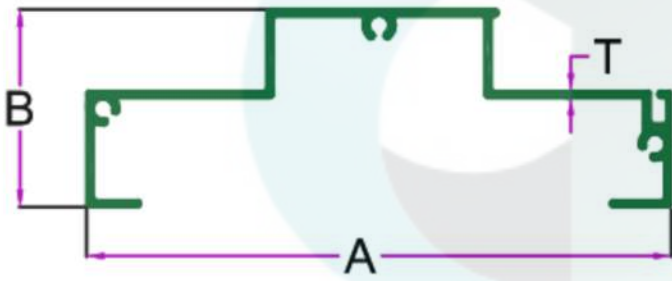

S. No.	Section No.	A IN mm.	B IN mm.	T IN mm.	Weight. (KG./ 12')
1	2056	125.78	39.7	1.50	1.010-1.250
2	2057	125.78	39.7	3.00	2.024-2.300

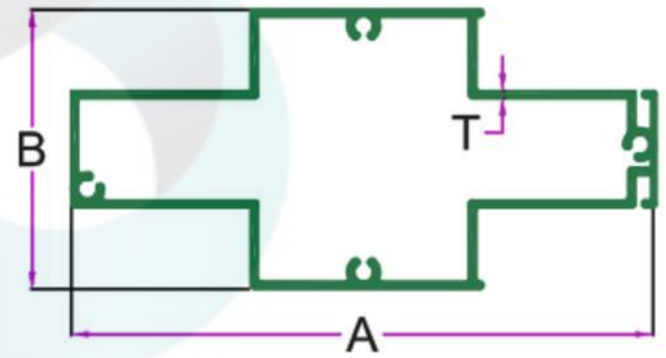

S. No.	Section No.	A IN mm.	B IN mm.	T IN mm.	Weight. (KG./ 12')
1	2058	125.78	58.40	1.50	1.640-1.850
2	2059	125.78	58.40	3.00	3.290-3.450



42MM CASEMENT SECTIONS

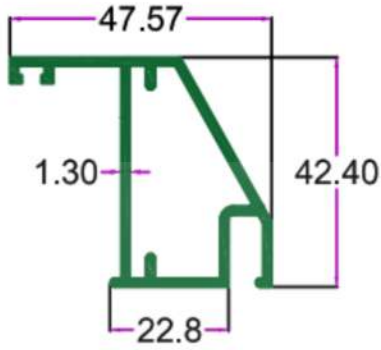

SEC. NO. 2181
WT. 1.900 TO 2.200 KG/12'

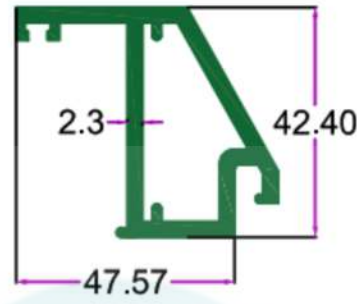

SEC. NO. 2182
WT. 3.950 TO 4.100 KG/15'

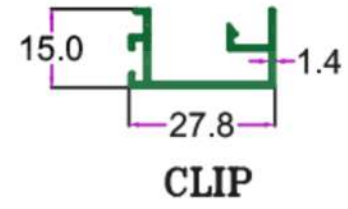

SEC. NO. 2164
WT. 1.050 TO 1.240 KG/15'

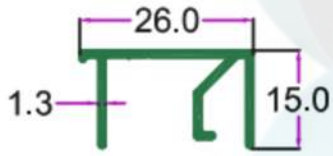

SEC. NO. 2203
WT. 1.050 TO 1.400 KG/15'

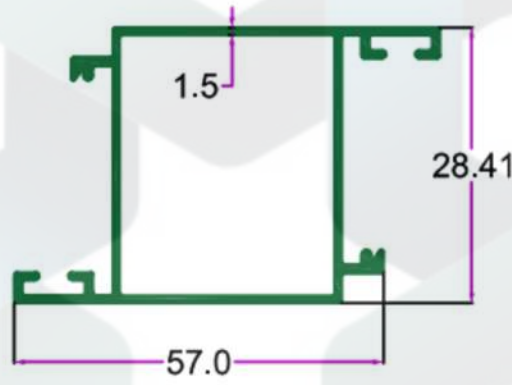

SEC. NO. 2204
WT. 2.600 TO 3.100 KG/15'

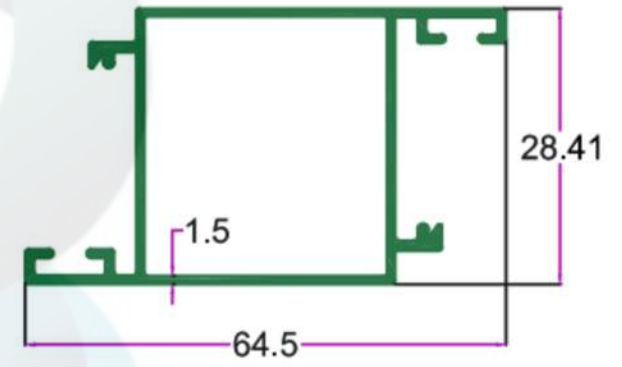

SEC. NO. 2205
WT. 3.250 TO 3.750 KG/15'

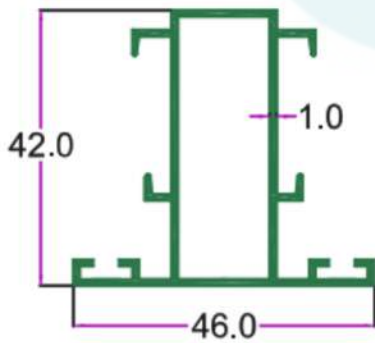

MULLION

SEC. NO. 2161
WT. 2.200 TO 2.700 KG/15'

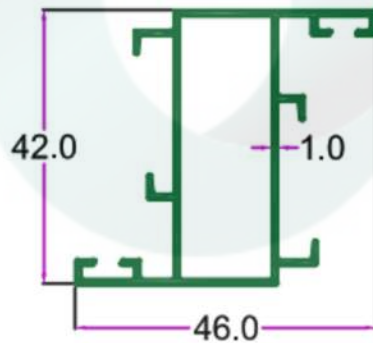

HOLLOW-Z

SEC. NO. 2162
WT. 2.300 TO 2.800 KG/15'

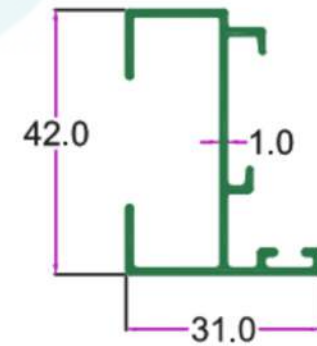

LAME-Z

SEC. NO. 2163
WT. 2.200 TO 2.500 KG/15'

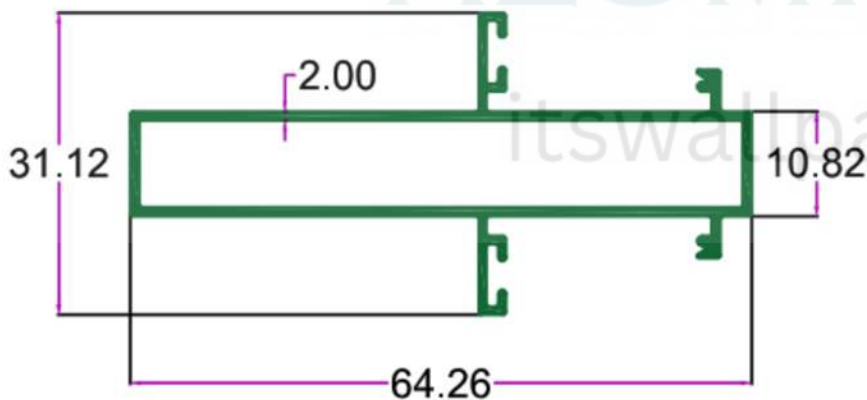

SEC. NO. 2201
WT. 3.900 TO 4.400 KG/15'

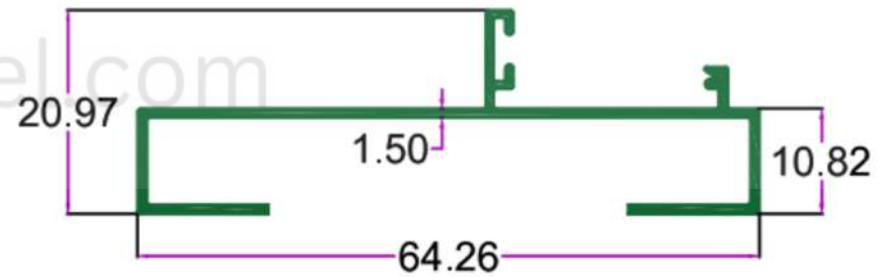

SEC. NO. 2202
WT. 2.600 TO 3.100 KG/15'



42MM CASEMENT SECTIONS

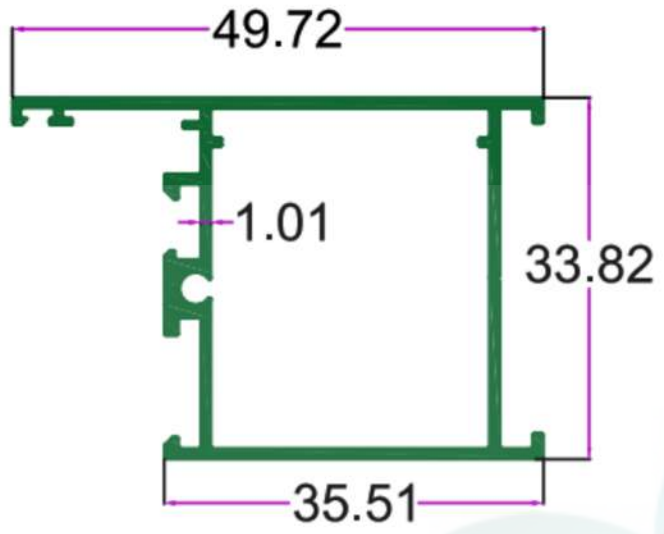

SEC.NO. 4771
WT. 3.320 TO 3.520 KG/I2'

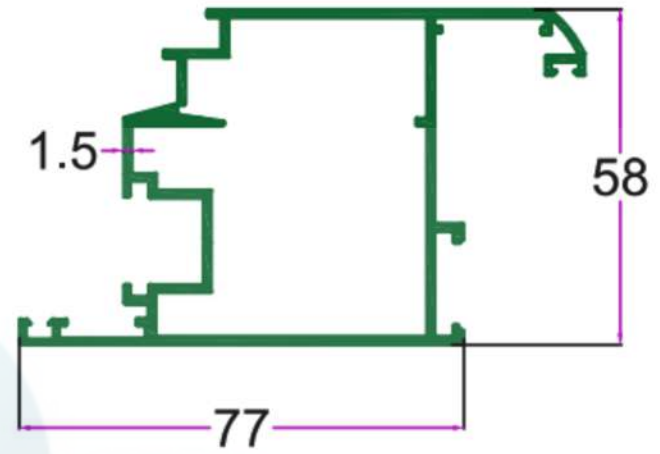

SEC.NO. 4774
WT. 5.150 TO 5.400 KG/I2'

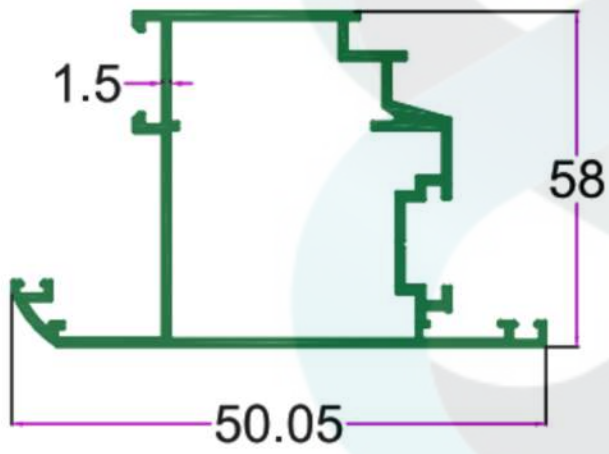

SEC.NO. 4775
WT. 3.320 TO 3.520 KG/I2'

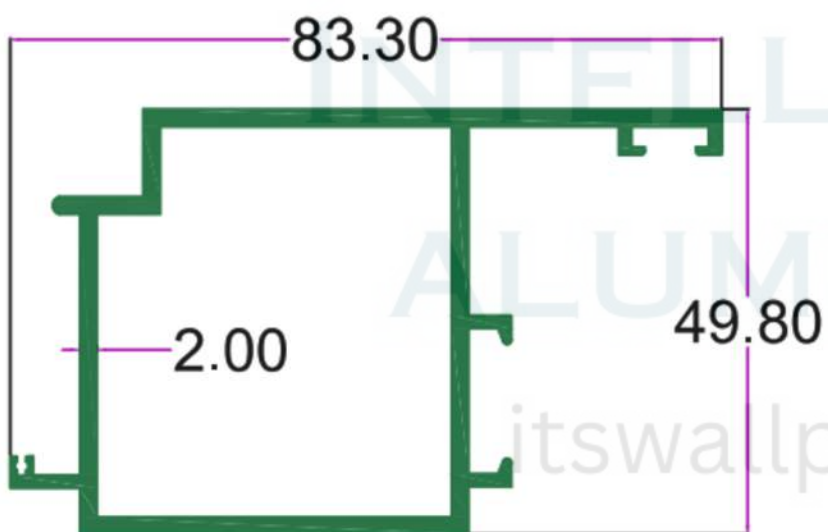

SEC. NO. 3933
WT. 4.700 TO 5.000 KG/I2'



50MM CASEMENT SECTIONS

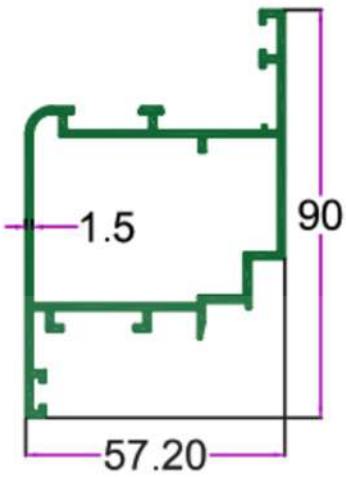

SEC. NO. 3940
WT. 4.400 TO 4.80 KG/12'



SEC. NO. 4768
WT. 3.320 TO 3.520 KG/12'

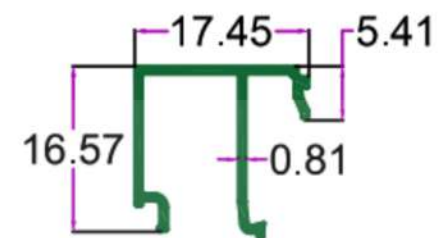

SEC. NO. 4770
WT. 1.020 TO 1.150 KG/12'

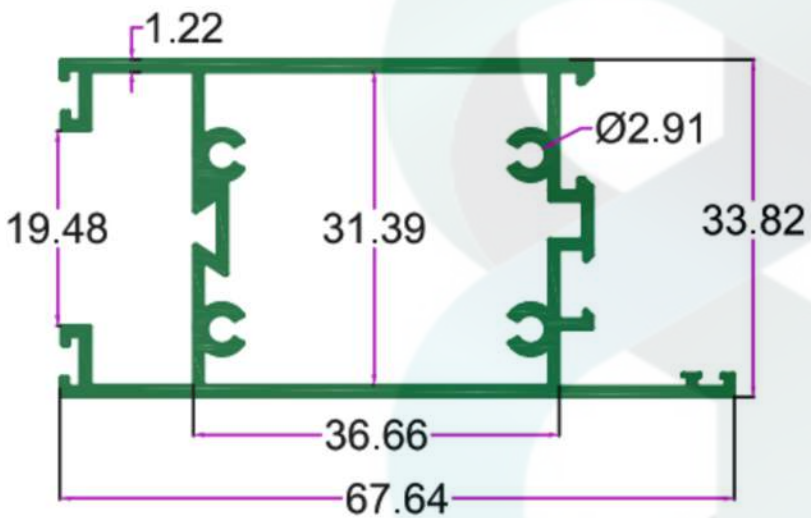

SEC. NO. 4769
WT. 6.550 TO 6.800 KG/12'

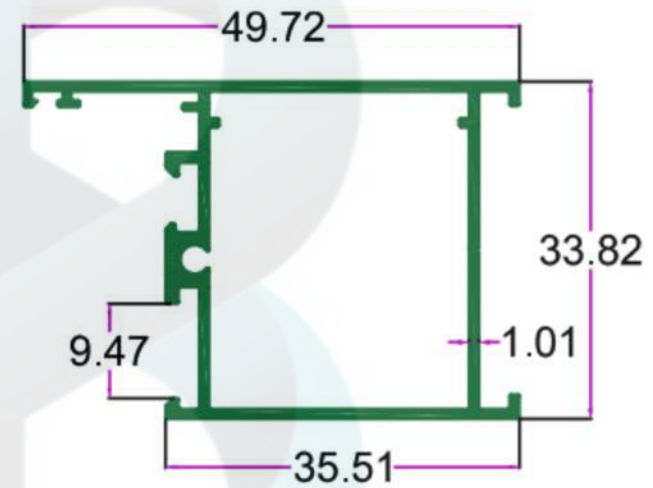

SEC. NO. 4771
WT. 3.320 TO 3.520 KG/12'

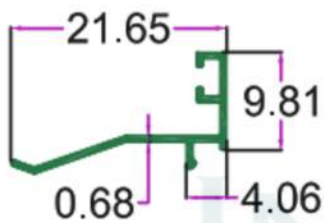

SEC. NO. 4773
WT. 0.600 TO 0.700 KG/12'

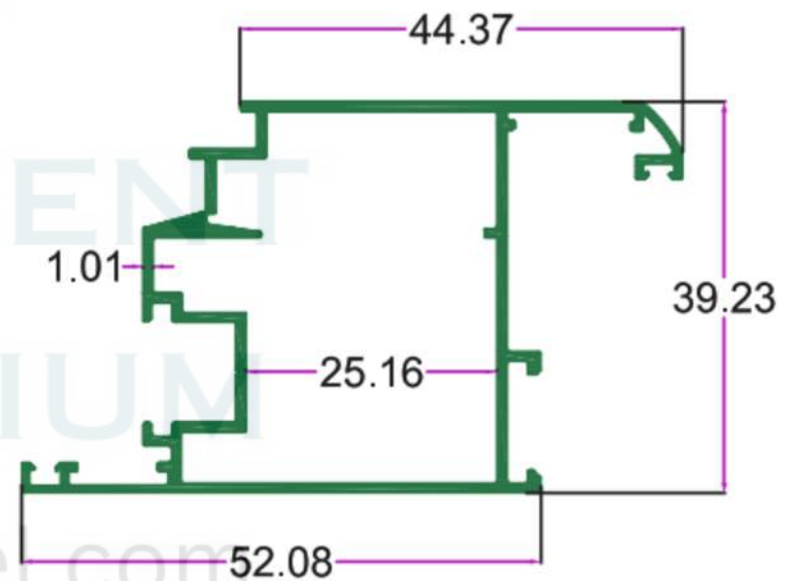

SEC. NO. 4774
WT. 5.150 TO 5.400 KG/12'

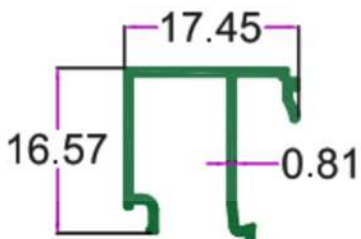

SEC. NO. 4770
WT. 1.030 TO 1.130 KG/12'



50MM CASEMENT SECTIONS

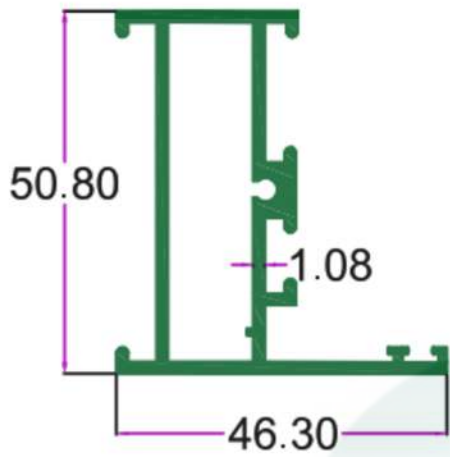

SEC. NO. 3778
WT. 3.600 TO 3.800 KG/12'

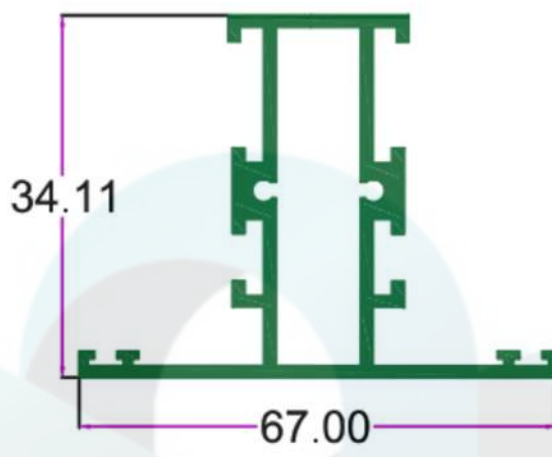

SEC. NO. 3779
WT. 4.50 TO 4.80 KG/12'

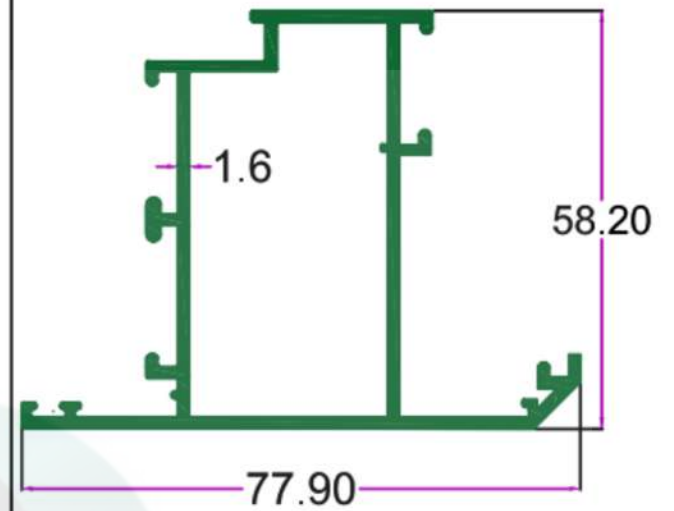

SEC. NO. 3780
WT. 4.200 TO 4.500 KG/12'

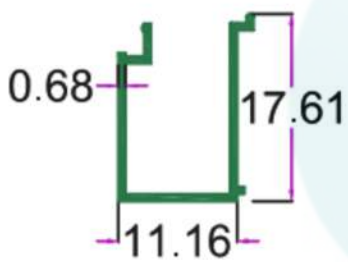

SEC. NO. 3781
WT. 0.70 TO 0.90 KG/12'

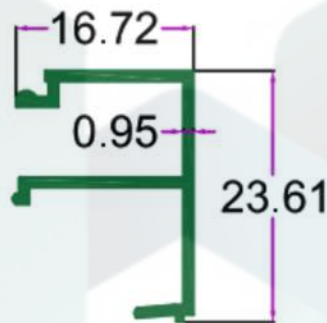

SEC. NO. 3782
WT. 1.20 TO 1.50 KG/12'

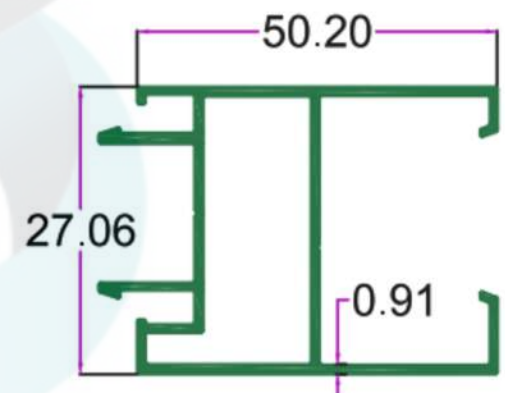

SEC. NO. 3783
WT. 2.850 TO 3.00 KG/12'

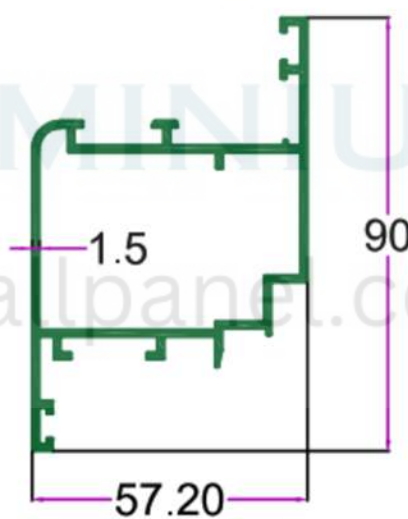

SEC. NO. 3940
WT. 4.400 TO 4.80 KG/12'

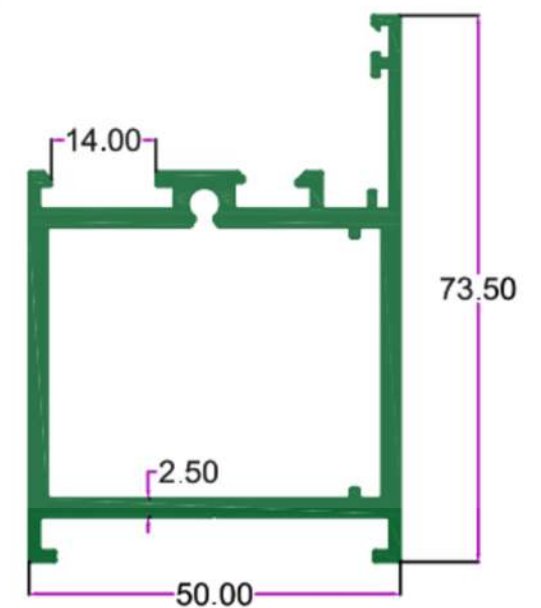

SEC. NO. 5211
WT. 5.530 TO 5.780 KG/12'



50MM CASEMENT SECTIONS

HINDALCO SERIES

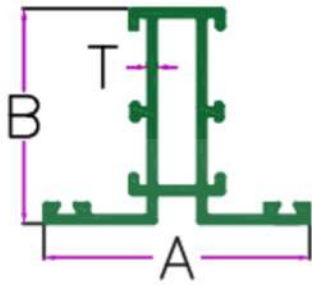

MULLION SECTION (H)

S No.	Section No.	A in mm.	B in mm.	T in mm.	Weight (KG/15')
1	2171	61.00	49.00	1.44	3.700-4.400
2	2172	61.00	49.00	1.80	4.500-5.200

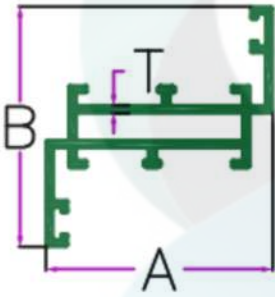

S No.	Section No.	A in mm.	B in mm.	T in mm.	Weight (KG/15')
1	2178	55.00	58.00	1.45	3.200-3.800
2	2179	55.00	58.00	1.90	4.500-5.000

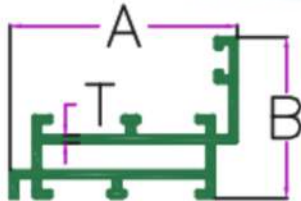

MULLION SECTION (H)

S No.	Section No.	A in mm.	B in mm.	T in mm.	Weight (KG/15')
1	2173	55.00	39.50	1.20	2.500-3.500
2	2174	55.00	39.50	1.80	4.500-5.000

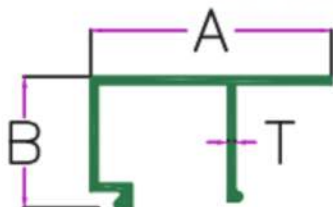

MULLION CLIP (H)

S No.	Section No.	A in mm.	B in mm.	T in mm.	Weight (KG/15')
1	2175	30.00	23.00	2.00	1.800-2.000
2	2176	35.00	23.00	1.00	1.000-1.200
3	2177	35.00	23.00	1.20	1.200-1.500

JINDAL SERIES

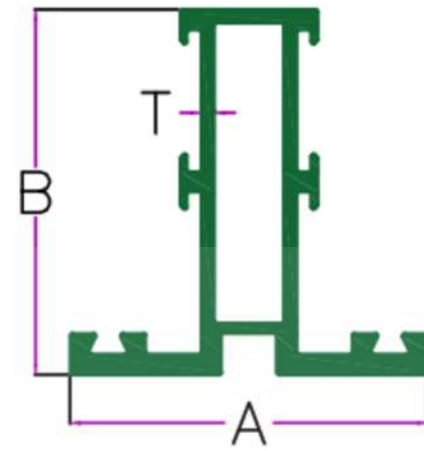

MULLION SECTION (J)

S No.	Section No.	A in mm.	B in mm.	T in mm.	Weight (KG/15')
1	2151	52.00	53.00	1.90	4.400-5.000
2	2152	52.00	53.00	2.20	5.100-5.500

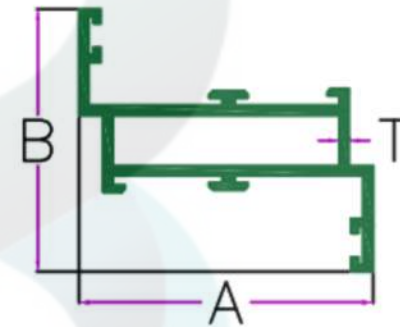

HOLLOW Z (J)

S No.	Section No.	A in mm.	B in mm.	T in mm.	Weight (KG/15')
1	2153	57.00	52.00	1.70	4.000-4.700
2	2154	57.00	52.00	2.20	5.000-5.700

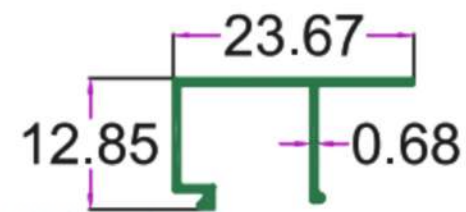

MULLION CLIP (J)

SEC. NO. 2155

WT. 1.200 TO 1.600 KG/15'

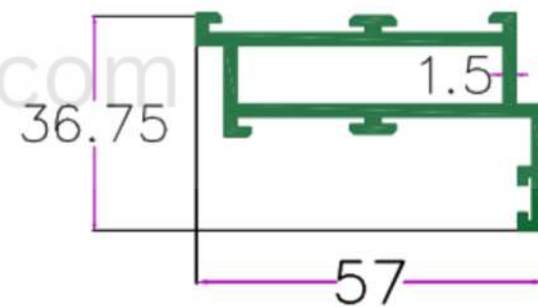

SEC. NO. 3880

WT. 4.600 TO 4.900 KG/15'



MISCELLANEOUS SLIDING WINDOWS

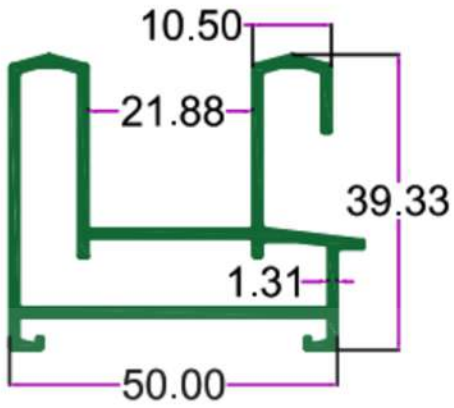

SEC.NO. 4845
WT. 3.650 TO 3.870 KG/12'

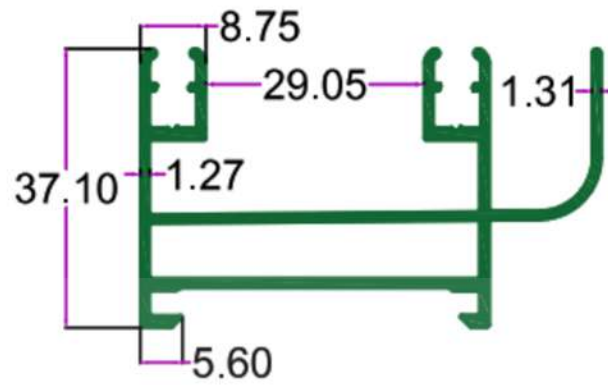

SEC.NO. 4843
WT. 4.180 TO 4.400 KG/12'

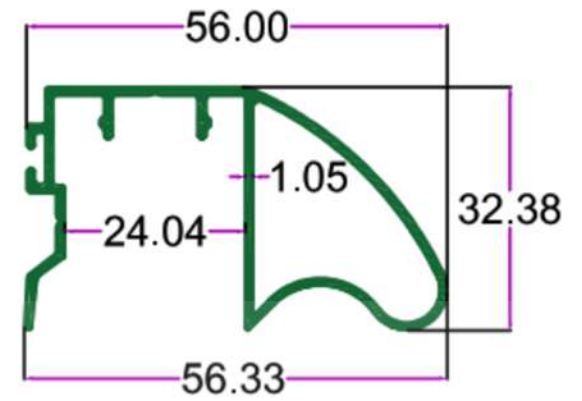

SEC.NO. 4847
WT. 2.580 TO 2.850 KG/12'

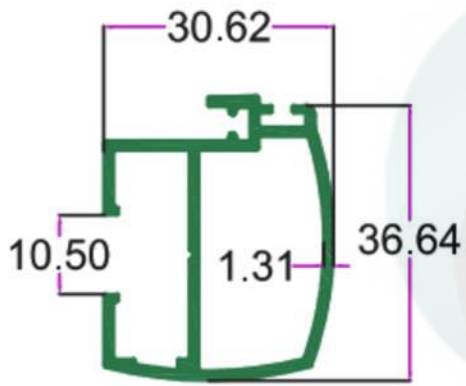

SEC.NO. 4844
WT. 2.630 TO 2.850 KG/12'

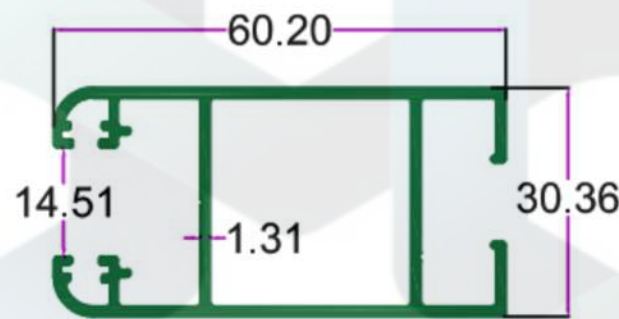

SEC.NO. 4842
WT. 3.760 TO 4.000 KG/12'

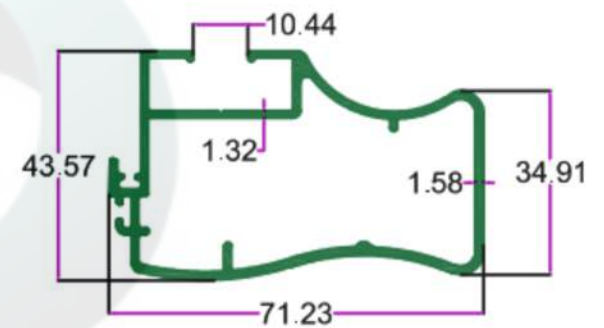

SEC.NO. 4848
WT. 4.880 TO 5.130 KG/12'

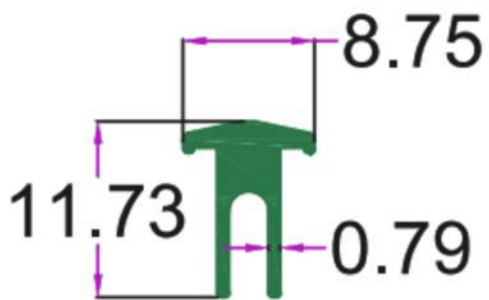

SEC.NO. 4846
WT. 0.470 TO 0.570 KG/12'

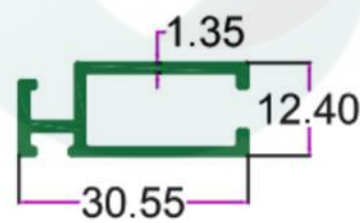

SEC.NO. 5118
WT. 0.995 TO 1.245 KG/12'

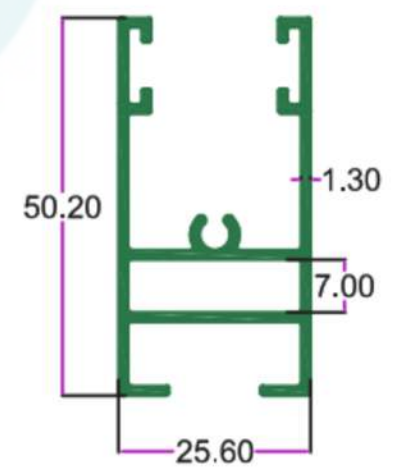

SEC.NO. 4965
WT. 2.410 TO 2.600 KG/12'

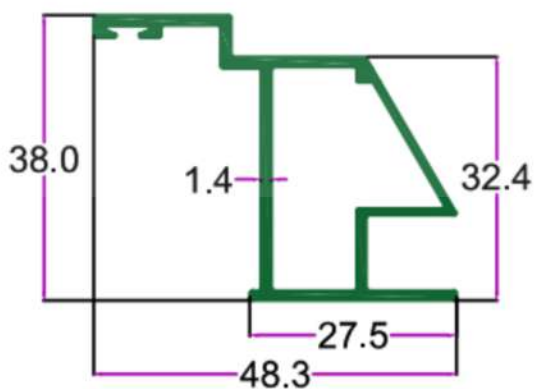

SEC. NO. 3458
WT. 1.900 TO 2.200 KG/12'

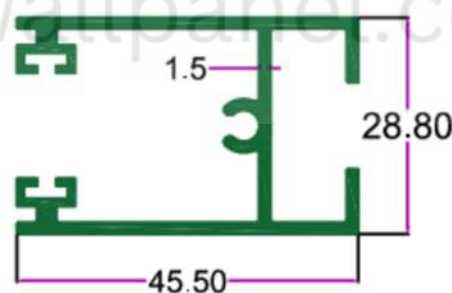

SEC. NO. 3651
WT. 2.500 TO 2.750 KG/12'

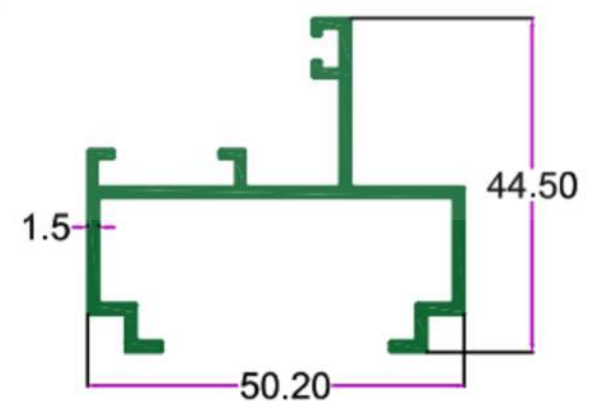

SEC. NO. 3650
WT. 2.200 TO 2.500 KG/12'

DOMAL /CASEMENT/MESH



INTELLIGENT
ALUMINIUM
itswallpanel.com

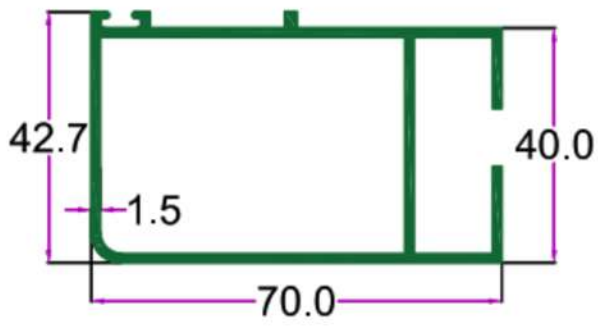

SEC. NO. 2801
WT. 3.700 TO 4.200 KG/12'

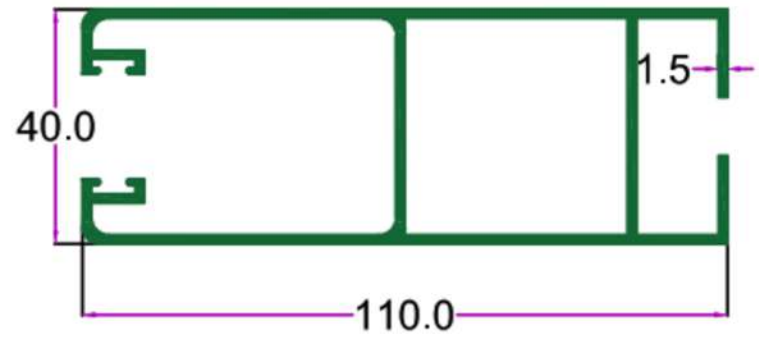

SEC. NO. 2802
WT. 5.400 TO 5.900 KG/12'



SEC. NO. 2803
WT. 5.350 TO 5.750 KG/12'

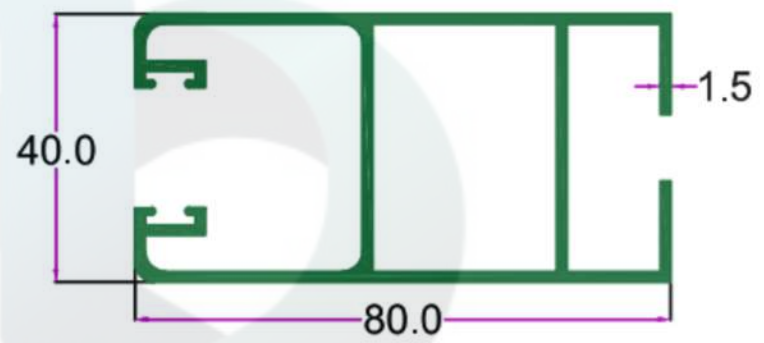

SEC. NO. 2804
WT. 4.500 TO 5.000 KG/12'

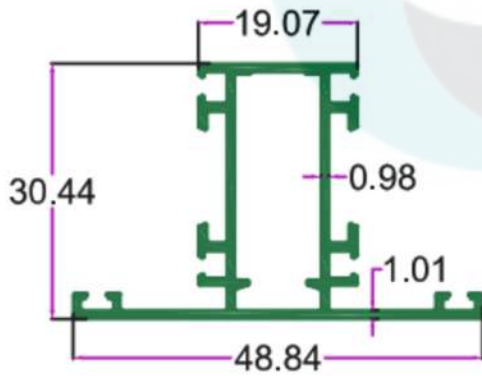

SEC. NO. 4930
WT. 3.720 TO 3.980 KG/12'

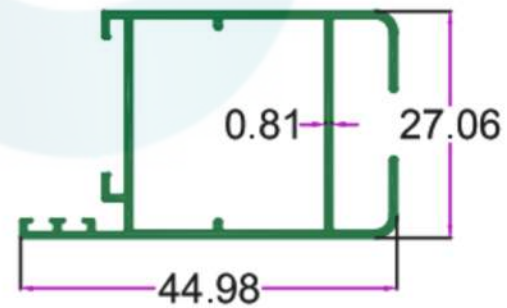

SEC. NO. 3464
WT. 3.500 TO 3.700 KG/12'

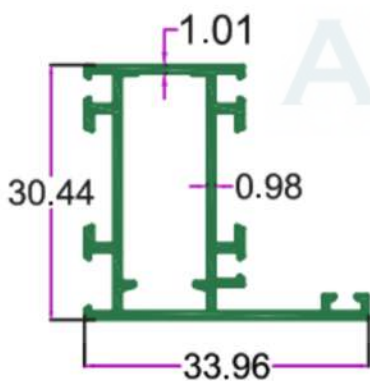

SEC. NO. 4929
WT. 3.225 TO 3.500 KG/12'

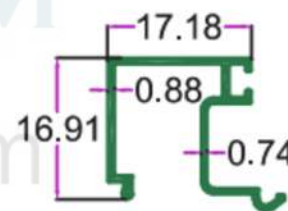

SEC. NO. 4931
WT. 1.200 TO 1.350 KG/12'



MISCELLANEOUS SLIDING WINDOWS

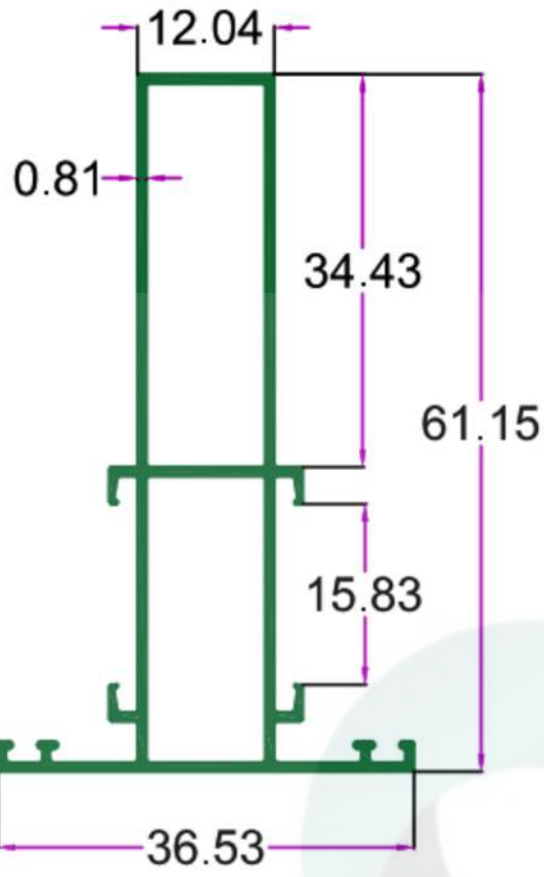

SEC. NO. 4271
WT. 3.500 TO 3.800 KG./ 12'

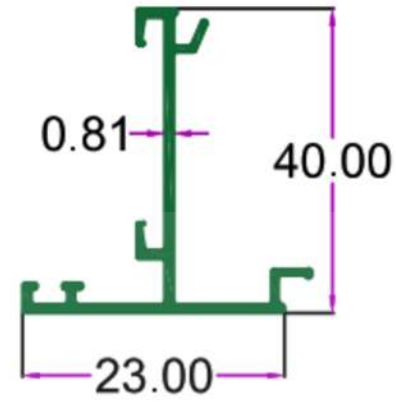

SEC. NO. 4270
WT. 1.200 TO 1.400 KG./ 12'

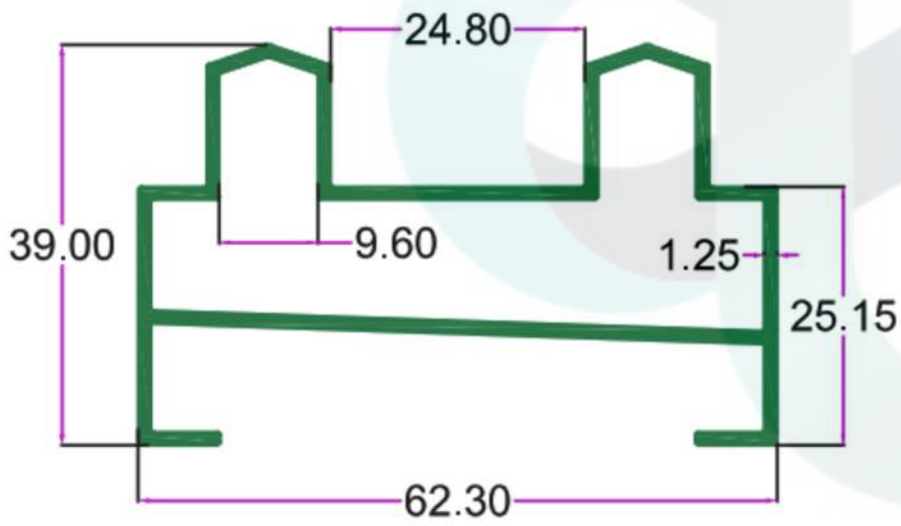

SEC. NO. 4854
WT. 2.870 TO 3.080 KG/12'

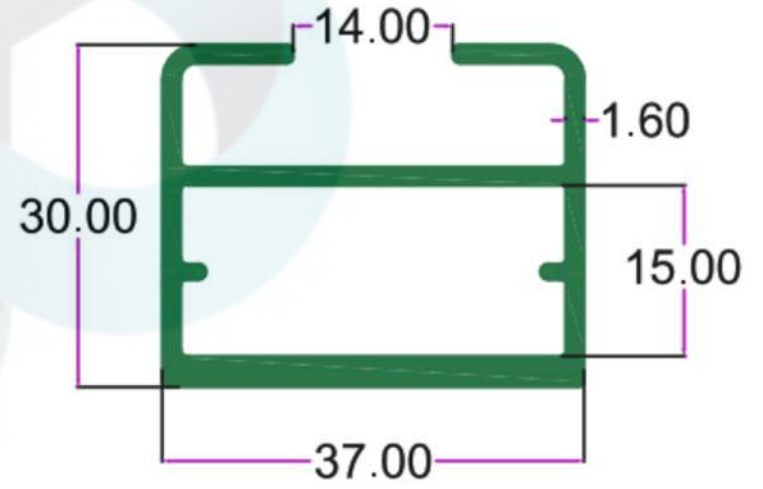

SEC. NO. 4874
WT. 2.720 TO 2.950 KG/12'

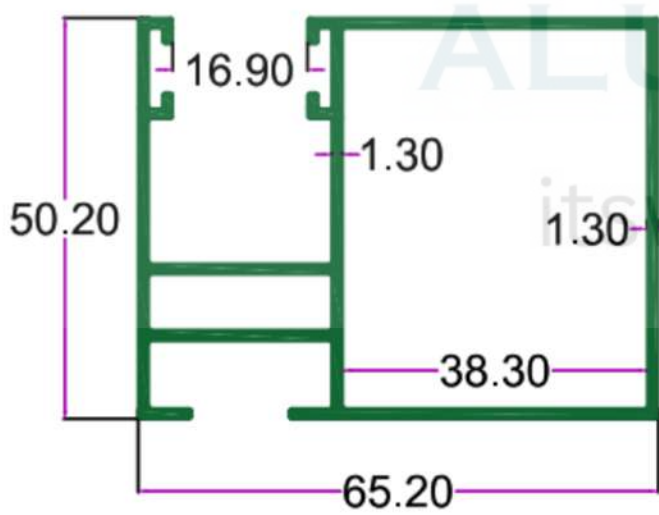

SEC. NO. 4852
WT. 3.900 TO 4.120 KG/12'

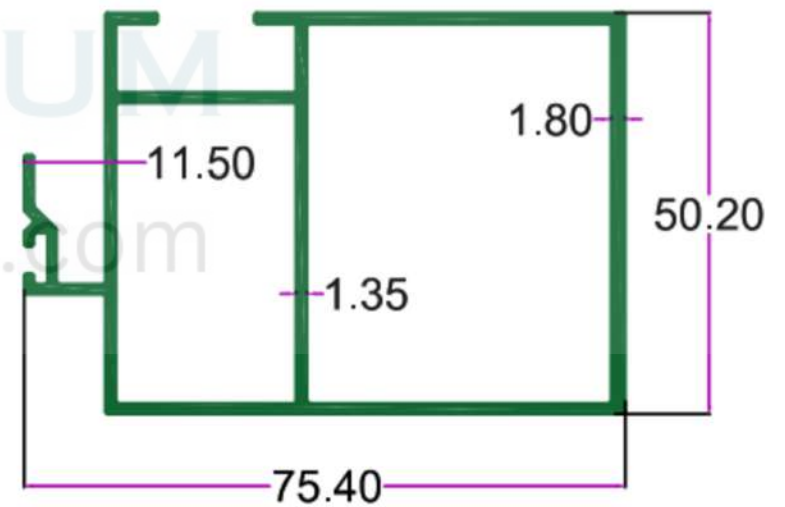

SEC. NO. 4853
WT. 4.360 TO 4.600 KG/12'



MISCELLANEOUS SLIDING WINDOWS

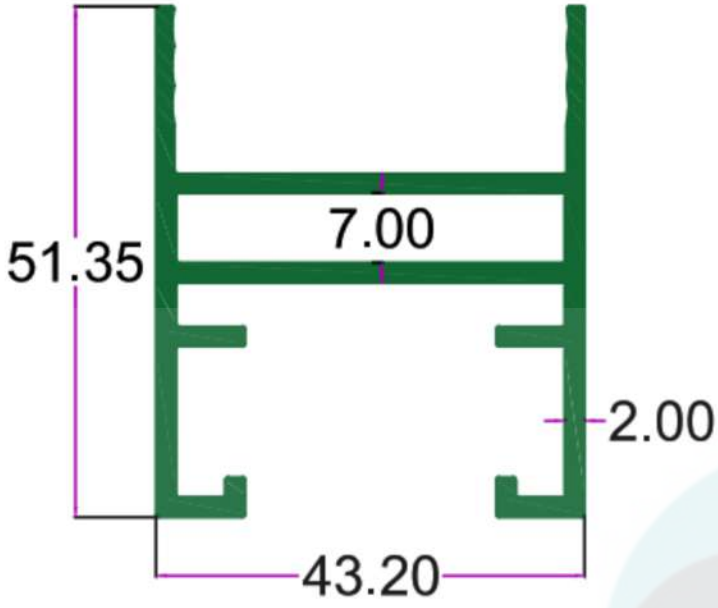

SEC.NO. 5238
WT. 4.118 TO 4.368 KG/I2'

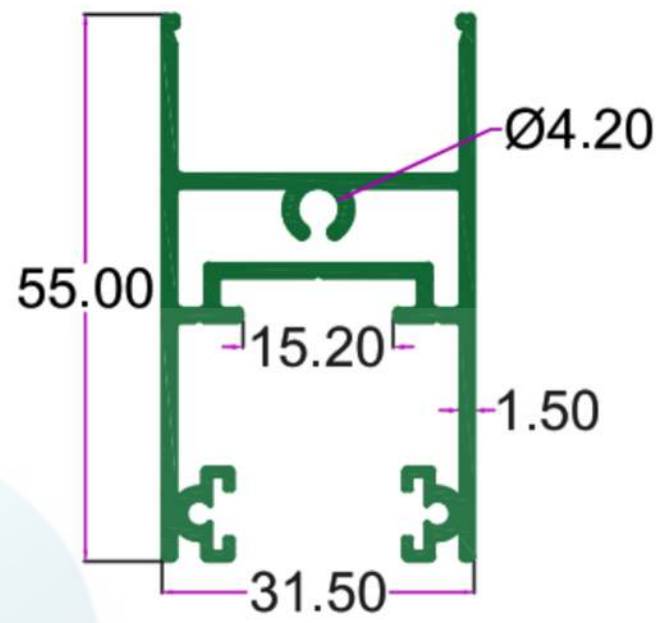

SEC.NO. 5240
WT. 3.315 TO 3.565 KG/I2'

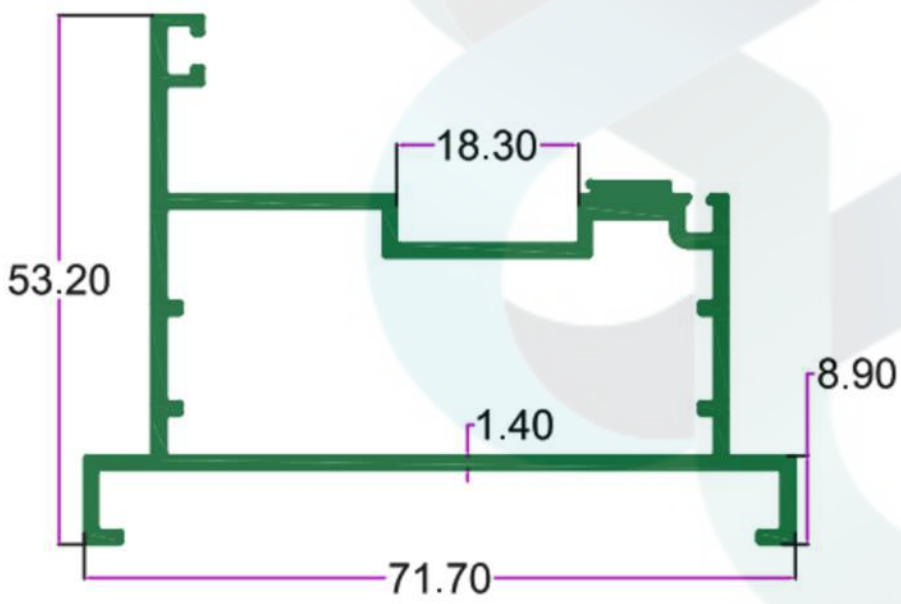

SEC.NO. 5009
WT. 3.625 TO 3.850 KG/I2'

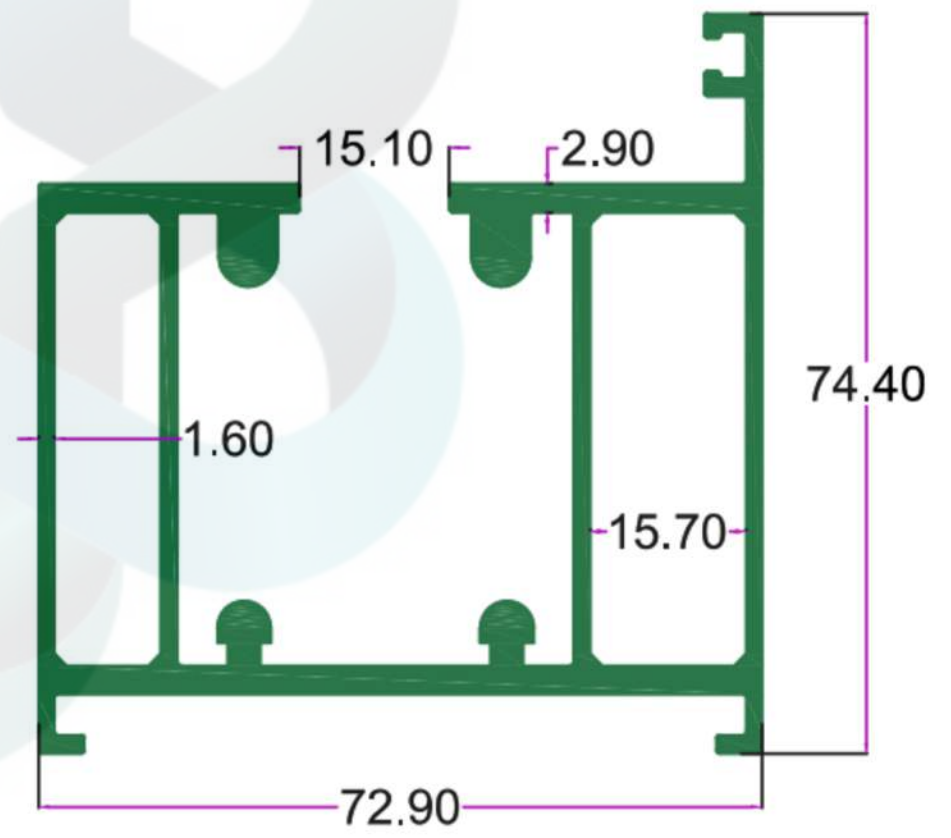

SEC.NO. 5008
WT. 8.860 TO 9.300 KG/I2'

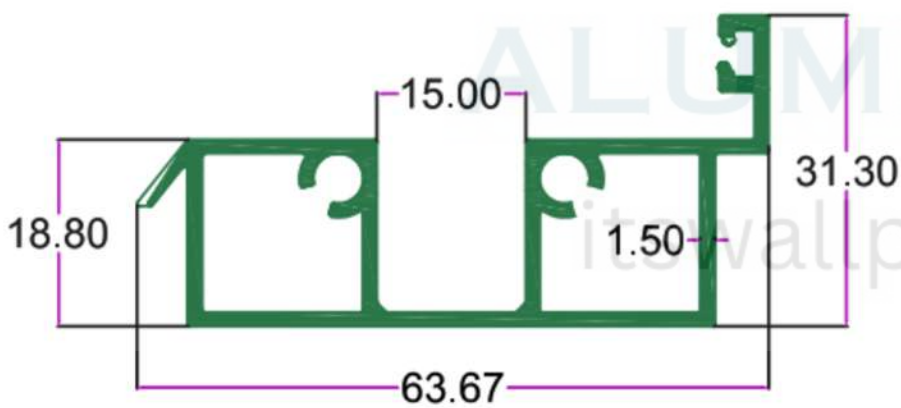

SEC.NO. 5010
WT. 2.900 TO 3.150 KG/I2'

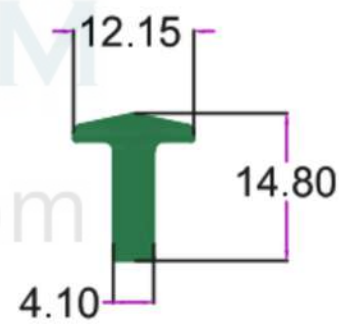

SEC.NO. 4838
WT. 0.750 TO 0.900 KG/I2'



FOLDING SECTIONS

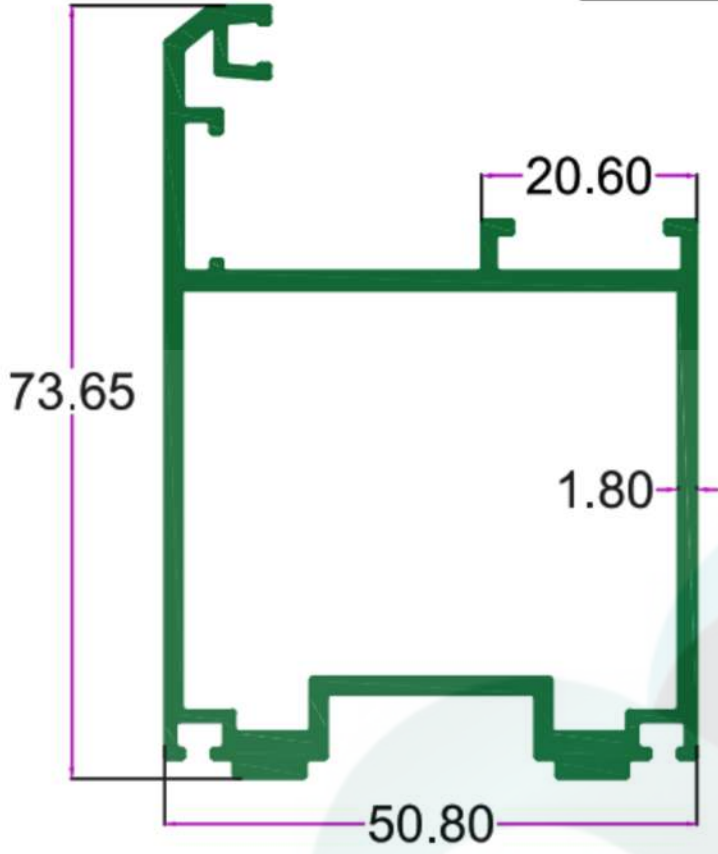

SEC.NO. 5006
WT. 4.735 TO 4.950 KG/12'

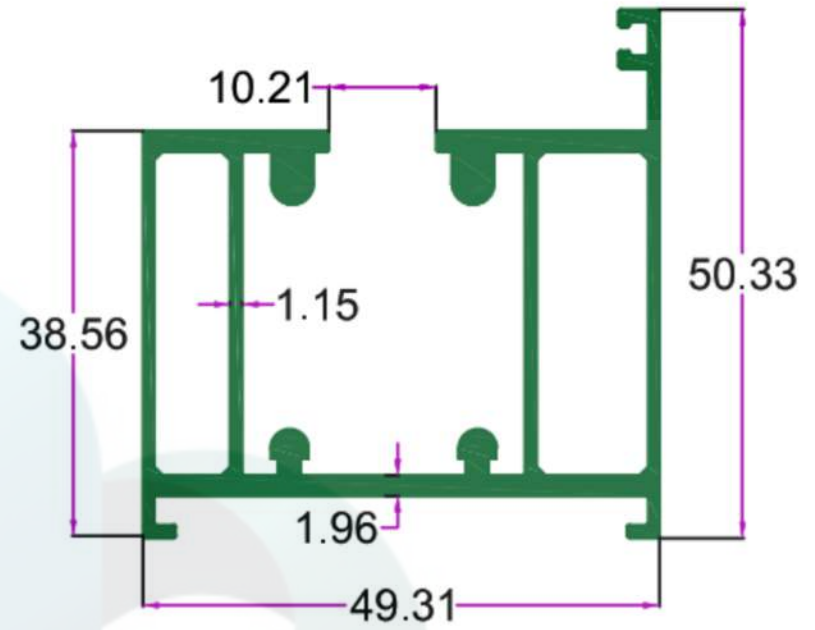

SEC. NO. 5008
WT. 8.860 TO 9.000 KG/12'

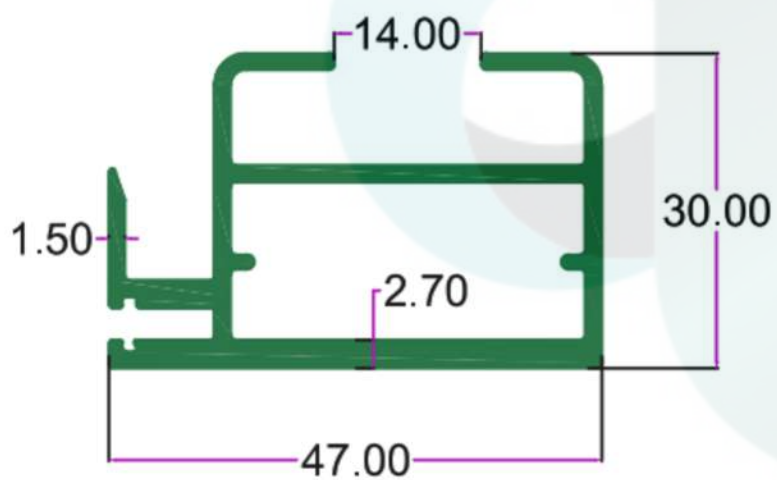

SEC.NO. 4977
WT. 3.375 TO 3.570 KG/12'

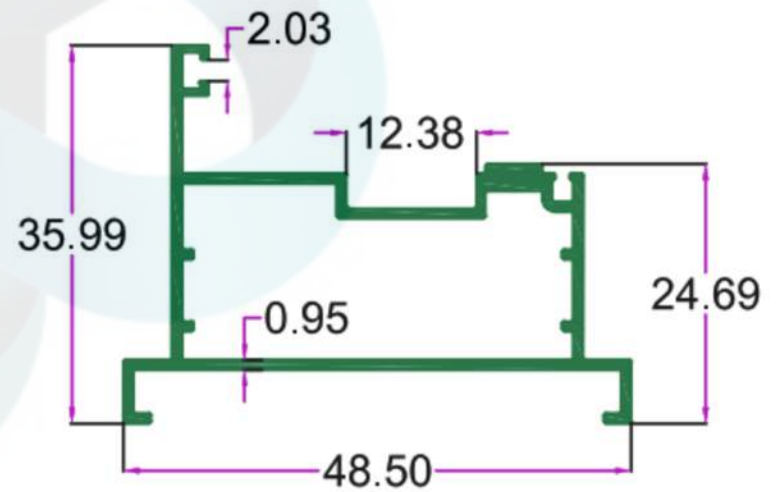

SEC. NO. 5009
WT. 3.625 TO 3.850 KG/12'

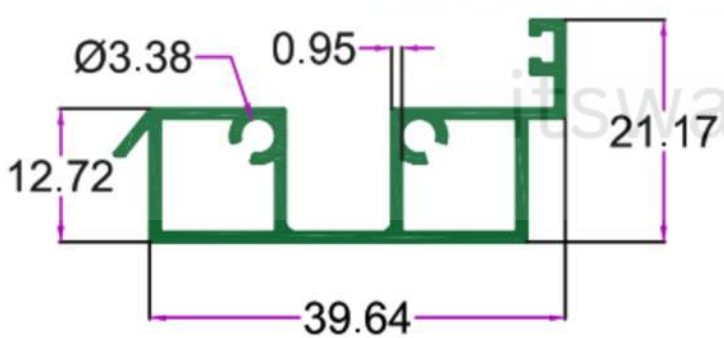

SEC. NO. 5010
WT. 2.900 TO 3.100 KG/12'

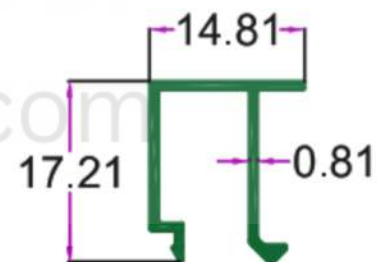

SEC. NO. 5007
WT. 0.940 TO 1.100 KG/12'



75MM CASEMENT SECTIONS

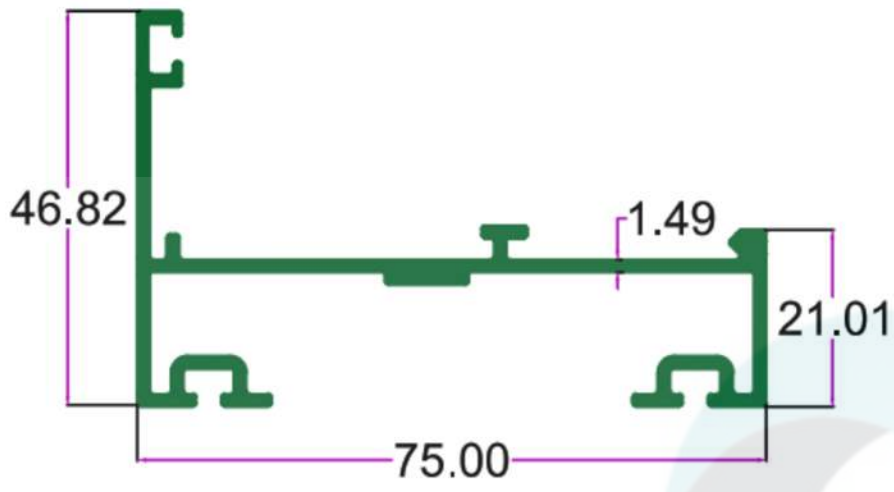

SEC.NO. 5113
WT. 3.340 TO 3.590 KG/12'

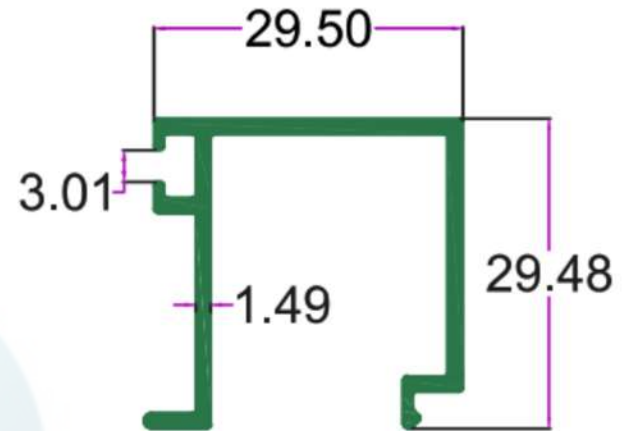

SEC.NO. 5114
WT. 1.480 TO 1.730 KG/12'

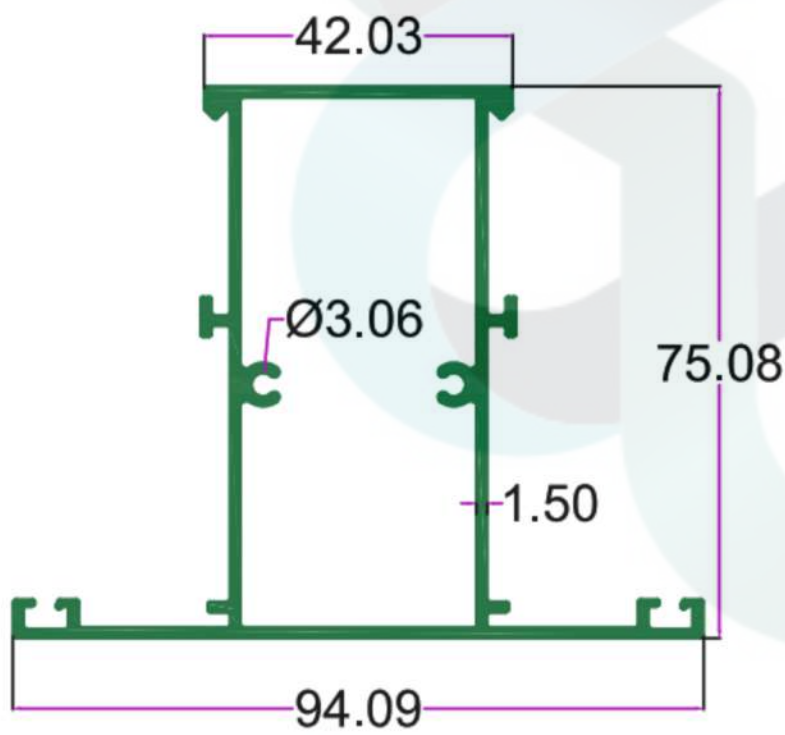

SEC.NO. 5116
WT. 5.270 TO 5.520 KG/12'

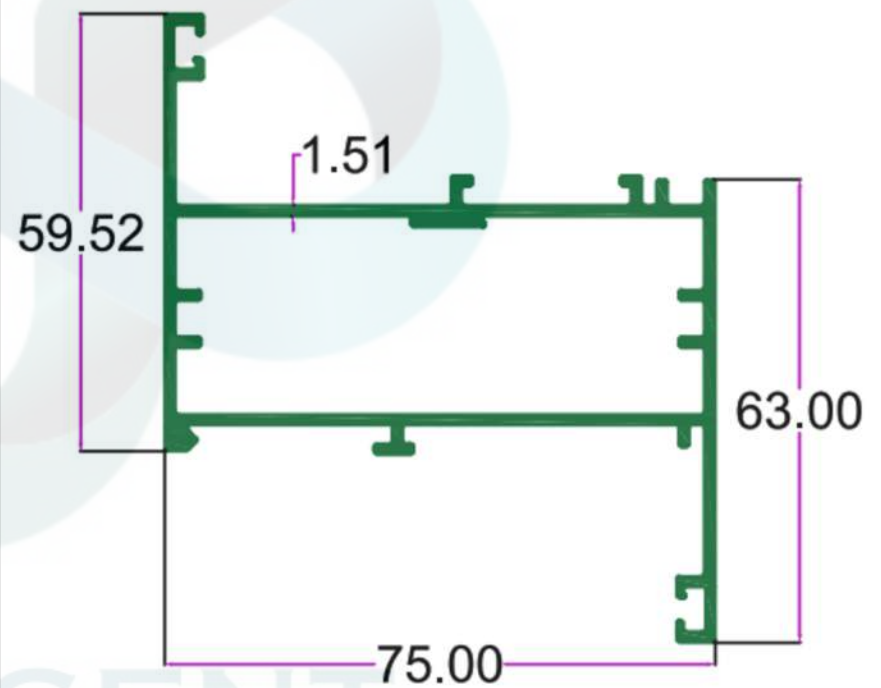

SEC.NO. 5115
WT. 5.030 TO 5.280 KG/12'

DOMAL /CASEMENT/MESH



INTELLIGENT
ALUMINIUM
itswallpanel.com

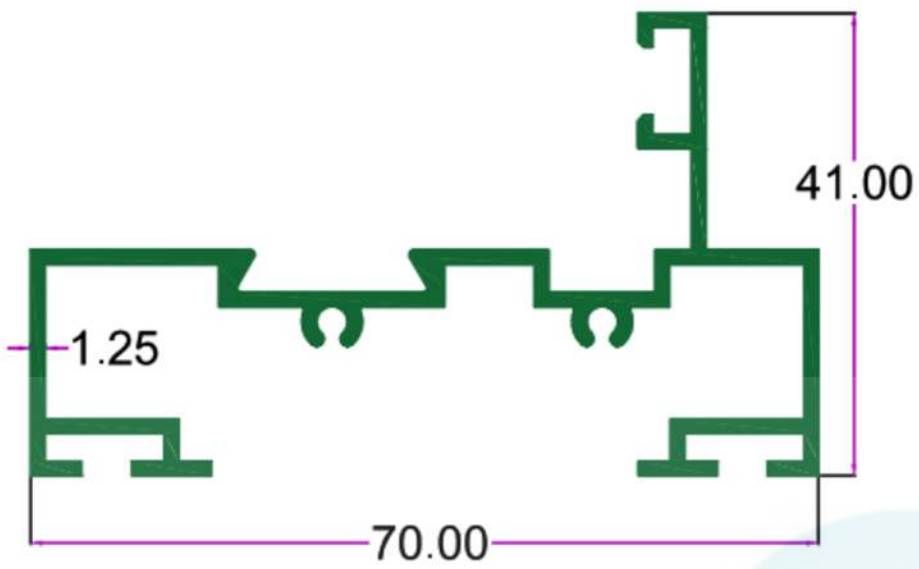

SEC. NO. 2206
WT. 3.500 TO 4.200 KG/15'

SEC. NO. 3648
WT. 5.450 TO 6.000 KG/12'

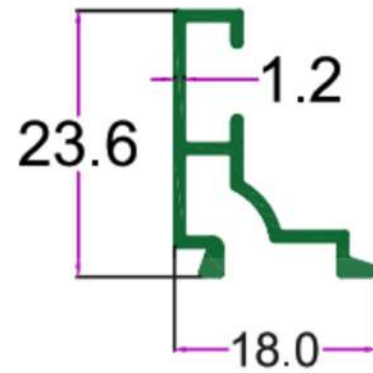

SEC. NO. 2209
WT. 0.950 TO 1.100 KG/15'

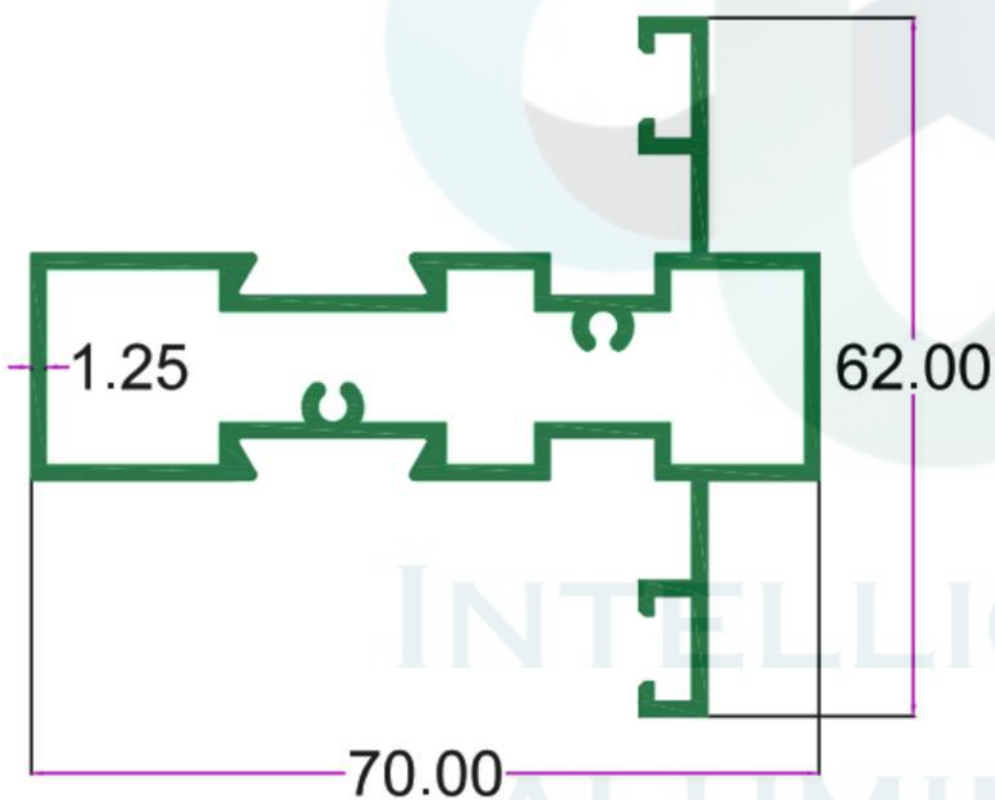

SEC. NO. 2207
WT. 4.900 TO 5.500 KG/15'

SEC. NO. 3649
WT. 7.525 TO 8.300 KG/15'

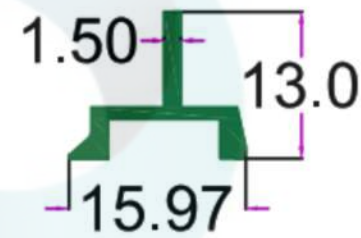

SEC. NO. 2210
WT. 0.525 TO 0.650 KG/15'

DOMAL /CASEMENT/MESH



INTELLIGENT
ALUMINIUM
itswallpanel.com

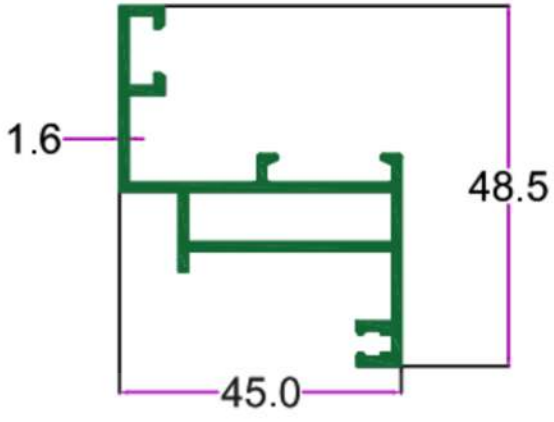

SEC. NO. 2208
WT. 2.500 TO 3.500 KG/15'

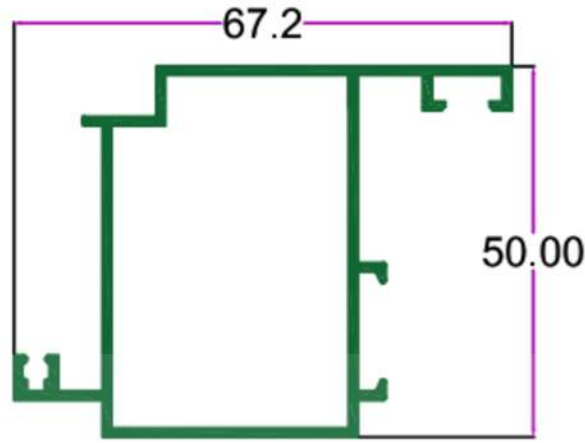

SEC. NO. 2212
WT. 5.900 TO 6.200 KG/15'

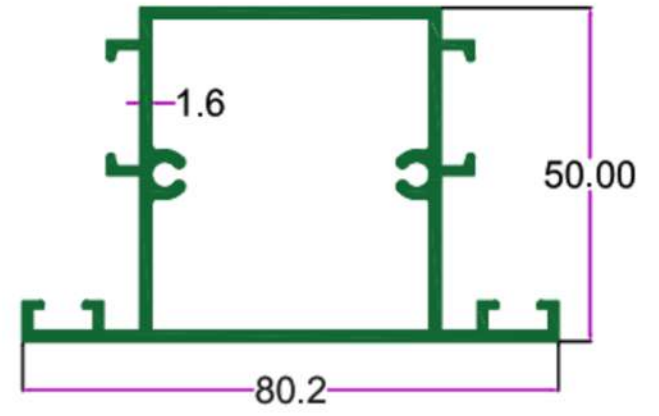

SEC. NO. 2213
WT. 6.800 TO 7.100 KG/15'

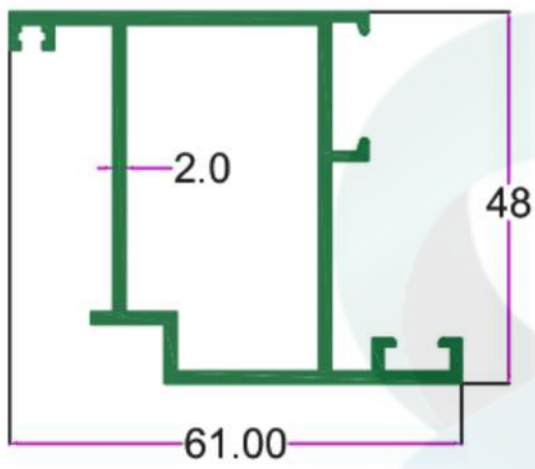

SEC. NO. 2215
WT. 4.550 TO 4.850 KG/15'

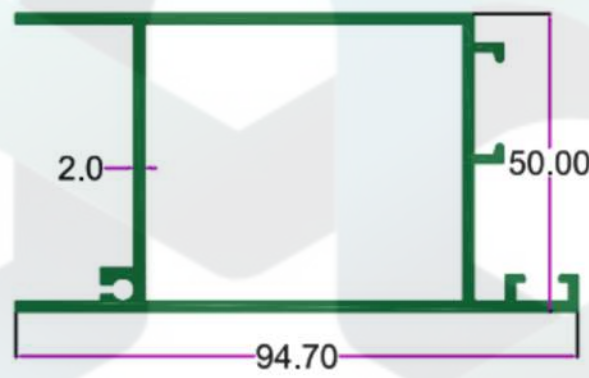

SEC. NO. 2214
WT. 7.250 TO 7.500 KG/15'

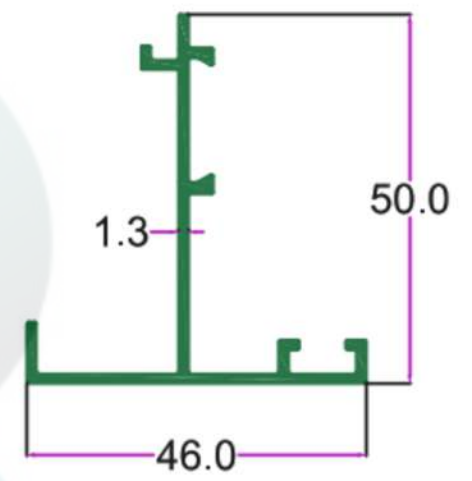

SEC. NO. 3609
WT. 1.600 TO 1.800 KG/12'

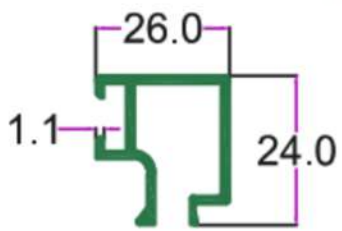

SEC. NO. 2211
WT. 1.250 TO 1.350 KG/15'

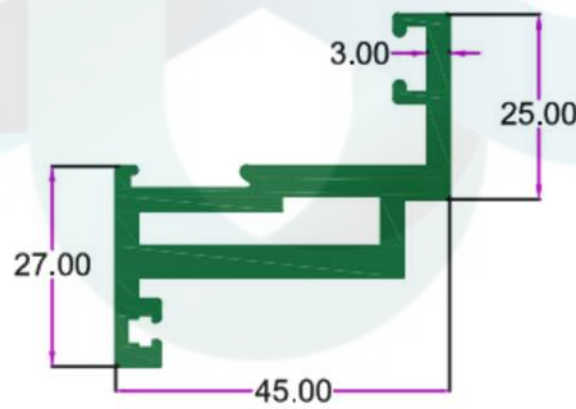

SEC. NO. 3613
WT. 4.700 TO 5.150 KG/12'

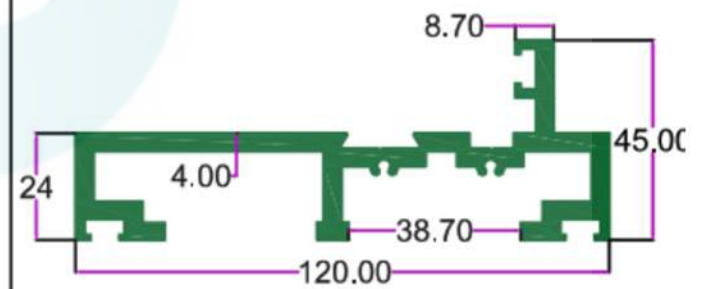

SEC. NO. 3610
WT. 9.500 TO 10.600 KG/12'

SEC. NO. 3646(T 2 MM)
WT. 5.540 TO 6.120 KG/12'

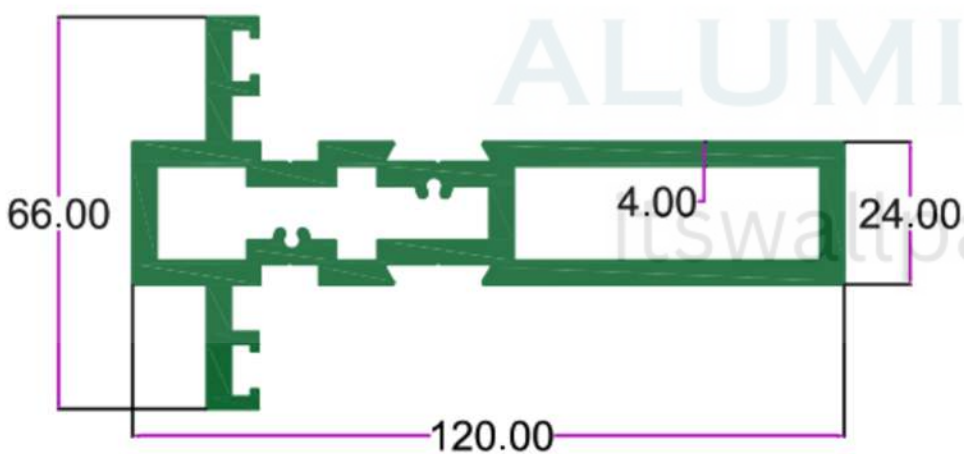

SEC. NO. 3611
WT. 13.300 TO 14.700 KG/12'
SEC. NO. 3647(T 2MM)
WT. 7.500 TO 8.250 KG/12'

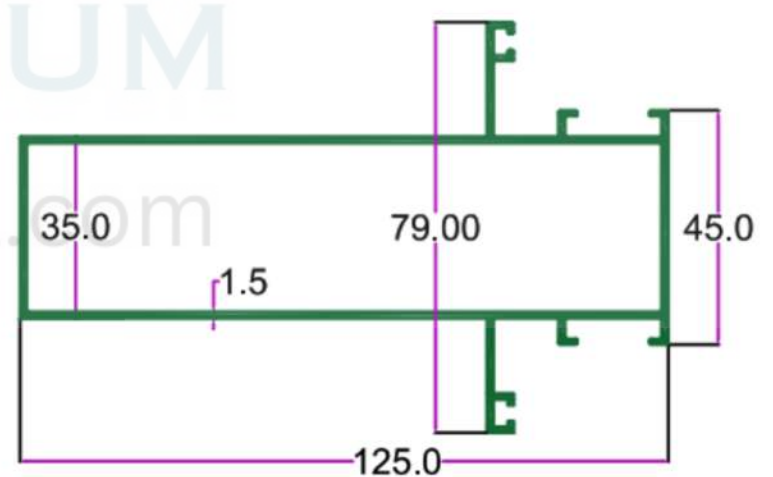

SEC. NO. 3514
WT. 5.600 TO 6.200 KG/12'